

**Makita**<sup>®</sup>

Catálogo de  
**ACESSÓRIOS**  
2023 / 24

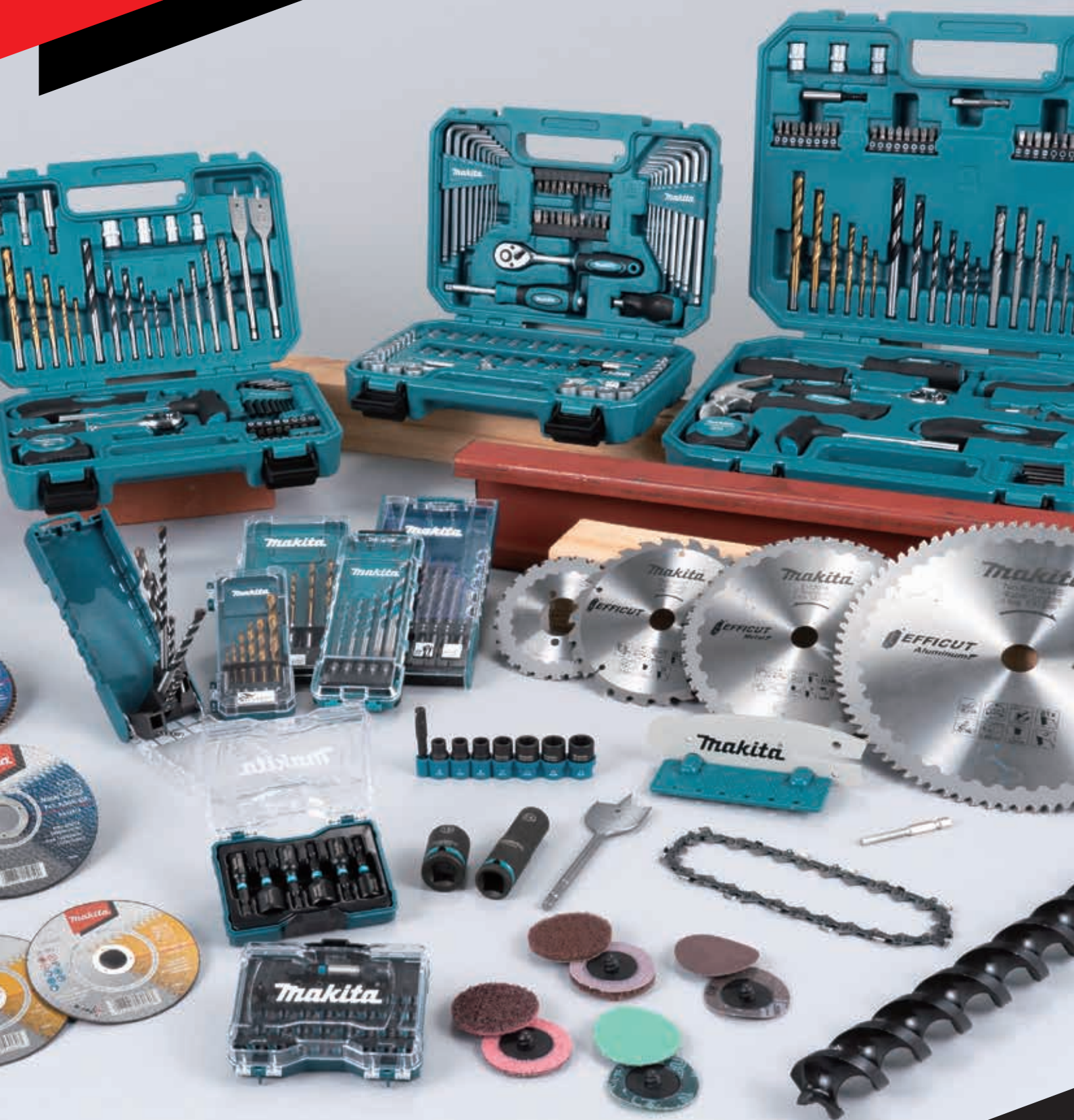

## HISTÓRIA

A Makita tornou-se um dos principais fabricantes mundiais de ferramentas elétricas portáteis, com 11 fábricas em todo o mundo e um grande número de subsidiárias. Com uma seleção de mais de 700 modelos de qualidade superior e fabricados com a mais avançada tecnologia, a Makita oferece a mais vasta gama de ferramentas elétricas.

Em março de 1915, Mosaburo Makita fundou a MAKITA ELECTRIC WORKS na cidade de Nagoya, uma loja especializada na venda e reparação de motores elétricos e transformadores.

Em 2010 foi fundada a Makita Portugal.

Ao longo dos anos, a empresa inicial passou por várias transformações:

- 1915 É fundada a Makita Electric Works na cidade de Nagoya. Começou por vender e reparar equipamentos elétricos, motores e transformadores.
- 1958  Teve início a comercialização de plainas elétricas, o primeiro produto no Japão.
- 1969  Berbequim a bateria 6500D (a primeira ferramenta a bateria).
- 1978  Lançamento do berbequim a bateria modelo 6010D (primeira ferramenta a bateria de Ni-Cd).
- 1981  Lançamento da pregadora pneumática AN5000 e do compressor de ar AC6001 (primeiras ferramentas pneumáticas).
- 1989  Três ferramentas elétricas (serra circular, rebarbadora, berbequim) desenhadas por Giorgetto Giugiaro são expostas na Exposição Mundial de Design na cidade de Nagoya.

- 1991  Aquisição da Sachs Dolmar GmbH, fabricante alemão de motoserras (designação alterada para Dolmar GmbH em 1991)
- 1991  Chega a segunda marca, MAKTEC.
- 1997  Berbequim aparafusador a bateria 6213D, exposto no salão de ferragens de Chicago (primeira ferramenta a bateria Ni-MH).
- 2005  Chegam os modelos BTD130D (primeiras ferramentas a bateria de lítio).
- 2007  A Fuji Robin Industries Ltd. torna-se uma subsidiária consolidada. (muda o seu nome para Makita Numazu Corporation em agosto de 2007)
- 2010  É fundada a Makita Portugal Lda.

- 2015  Comemoração do 100.º aniversário.
- 2020  Nasce a gama XGT, um novo sistema com as suas próprias ferramentas, baterias e carregadores. Uma combinação de ferramentas inovadoras. O design e as baterias mais potentes oferecem uma verdadeira solução para utilizadores industriais de elevada exigência.
- 2022  Chegámos onde não se esperava e lançámos uma série de modelos dedicados ao "Outdoor".

## Makita - Marca global

A Makita estabeleceu bases comerciais em cerca de 50 países em todo o mundo.

A nossa rede de vendas em mais de 160 países e as nossas capacidades de serviço pós-venda fazem de nós uma das empresas líderes na nossa indústria.

Além disso, a Makita produz ferramentas elétricas em fábricas na China, EUA, Reino Unido, Alemanha, Brasil, Romênia e Tailândia. Atualmente, aproximadamente 90 % do trabalho de fabrico do nosso grupo em termos de volume de produção é realizado no estrangeiro.

A rede mundial de vendas e serviços da Makita, assim como a qualidade estável e de alta produção assegurada nas suas fábricas em todo o mundo, são a personificação da marca Makita.



**Japão**  
Makita Corporação



**Japão**  
Fábrica Okazaki



**E.U.A.**  
Makita Corporação América



**Reino Unido**  
Fábrica Makita Europa Ltd.



**Roménia**  
SC Makita EU SRL



**Alemanha**  
Makita Engenharia  
Alemanha



**Brasil**  
Makita Brasil  
Ferramentas Elétricas Ltda.



**China**  
Makita (China) Co., Ltd.



**China**  
Makita (Kunshan) Co., Ltd.



**Tailândia**  
Fábrica Makita (Tailândia)  
Co., Ltd.



## ***Por uma sociedade descarbonizada.***

Makita simboliza o compromisso com o cuidado do meio ambiente. Trabalhamos para criar um modelo de reciclagem eficiente e responsável dirigido à sociedade, combinando a proteção do meio ambiente com uma mudança das nossas atividades de negócio e estilos de vida. Esperamos continuar a ser uma empresa que cuida com empenho da sociedade global, tendo como desafio uma contínua orientação com vista a uma reciclagem sustentável.

Modelo: UC012G



 @makita\_portugal

 Makita Portugal

 Makita Portugal

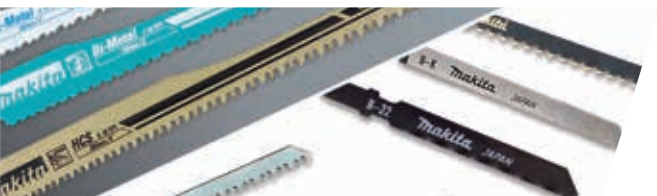

1. Baterias e carregadores	33 - 56
2. Perfuração e percussão	57 - 88
3. Furar	89 - 122
4. Aparafusar	123 - 144
5. Limpar e aplainar	145 - 156
6. Diamante	157 - 170
7. Abrasivo - Rebarbadoras	171 - 190
8. Abrasivo - Lixas	191 - 208
9. Multifunções	209 - 222
10. Serras circulares, de esquadria e de incisão	223 - 246
11. Serras de sabre	247 - 260
12. Serras tico-tico	261 - 272
13. Fresagem	273 - 286
14. Decapar	287 - 288
15. Parafusos e pregos	289 - 294
16. Aspiração	295 - 318
17. Níveis	319 - 322
18. Roedoras, tesouras e puncionadoras	323 - 326
19. Jardim	327 - 354
20. Porta-ferramentas	355 - 407
21. Baterias NI-Cd / NI-Mh	408
22. Malas	409 - 415
23. Escovas	416 - 417
24. Kits de manutenção	418
25. Índice por código	419 - 428
Serviços Técnicos Autorizados	431 - 432

**Índice**

**1. Baterias e carregadores**

- Baterias e carregadores. *págs. 34 - 37*
- Fontes de alimentação externas. *págs. 38 - 39*
- Kits de fontes de alimentação. *págs. 40 - 41*
- Adaptadores. *pág. 42*
- Protetores. *pág. 43*
- Vários. *págs. 44 - 47*
- Iluminação. *págs. 48 - 56*



**2. Perfuração e percussão**

- Brocas SDS - PLUS. *págs. 58 - 65*



- Brocas SDS - MAX. *págs. 66 - 70*



- Demolição. *págs. 71 - 82*



- Porta-brocas e diversos. *pág. 83*



- Sistemas de aspiração. *págs. 84 - 87*

- Punhos. *pág. 88*



**3. Furar**

- Brocas:

- Unicut. *pág. 90*
- Tijolo. *pág. 91*
- Multimaterial. *pág. 92*
- Madeira. *págs. 93 - 95*
- Metal. *págs. 96 - 100*



- Brocas para berbequim magnético

- HB500 e HB350. *pág. 101*



- Escareadores. *págs. 102 - 103*



- Estojos e malas de brocas e acessórios. *págs. 104 - 111*



- Brocas de coroa. *págs. 112 - 115*



- Batedores. *pág. 116*



- Suportes para berbequins. *págs. 118 - 119*



- Porta-brocas. *págs. 120 - 121*



**4. Aparafusar**

- Pontas. *pág. 126 - 127*



- *págs. 128 - 131*



- Porta-pontas. *pág. 132*



- Chaves de caixa. *págs. 133 - 134*



- Estojos de pontas. *págs. 135 - 136*



- Malas de ferramentas manuais. *págs. 137 - 139*



- Bocais e acessórios para aparafusadoras. *págs. 140 - 144*



**5. Limpar e aplainar**

- Catrabuchas para berbequins e rebarbadoras. *págs. 146 - 151*
- Catrabuchas de lixa para berbequins e rebarbadoras. *pág. 152*
- Rolos para N9741. *págs. 152 - 153*
- Lâminas para plainas. *pág. 154*
- Guias. *pág. 155*
- Vários. *págs. 156*



**6. Diamante**

- Discos de diamante:

- **quasar** *págs. 159*

- **comet** *págs. 160 - 162*

- **diamant** *pág. 163*

- Especial ferramentas a bateria. *pág. 164*

- X - LOCK. *pág. 164*

- Especial vidro e porcelana. *pág. 165*

- Especial resgate - Polir betão. *pág. 166*



- Brocas de diamante. *págs. 167 - 168*



- Brocas especiais para rebarbadora. *pág. 169*



- Suportes para DBM131, DBM130 e DBM230. *pág. 170*



- Acessórios para PW5005CH. *pág. 170*



**7. Abrasivo - Rebarbadoras**

- Discos abrasivos:

- Rebarbagem e corte. *págs. 172 - 173*

- Abrasivo. *págs. 174 - 175*

- Lâminas. *págs. 176 - 179*



- Moagem. *pág. 180*



- Punhos. *pág. 181*



- Coletores de pó. *pág. 181*



- Protetores de disco. *pág. 182*



- Vários:

- Porcas. *pág. 183*

- Filtros. *pág. 183*

- Casquilhos para rebarbadoras retas. *págs. 184-185*

- Aces. para cortadores. *págs. 186*

- PW5000CH. *pág. 187*

- PC5001C. *págs. 187 - 189*

- DCC501. *pág. 189*



**8. Abrasivo - Lixas**

- Orbitais. *págs. 192 - 196*

- Lixas.

- Rolos.

- Bases para lixadoras.

- Rotorbitais e de disco. *págs. 197 - 198*

- Lixas.

- Caixas de lixas.

- Pratos.

- Lixadoras de cinta. *págs. 200 - 201*

- Lixas.

- Placas.

- Pratos, boinas de lã. *págs. 202 - 204*

- Esponjas de velcro. *pág. 205*

- Vários *págs. 206 - 208*

- Suportes.

- Bolsas.

- Punhos.



**Índice**

**9. Multifunções**

- Starlock:
  - Corte e corte de imersão. *págs. 214 - 216*
  - Raspadores e lâminas de corte. *pág. 216*
  - Limpeza e corte. *págs. 217 - 218*
  - Conjunto de lâminas. *pág. 218*
  - Lixas. *pág. 219*
- Starlock Max:
  - Corte e corte de imersão. *pág. 220*
  - Lâminas de corte de juntas e de diamante. *págs. 221*
  - Lâminas de corte para azulejos. *pág. 222*
  - Limpeza e corte. *pág. 222*



**10. Serras circulares, de esquadria e de incisão**

- Discos para serras circulares. *págs. 225 - 234*



- Discos para serras de incisão. *pág. 235*



- Discos para serras de esquadria. *págs. 236 - 238*



- Discos para fresagem e corte. *pág. 239*
- Discos laminados cortadoras de metal. *págs. 240 - 241*
- Guias. *pág. 242 - 243*
- Mesas. *pág. 244*
- Vários. *págs. 245 - 246*



**11. Serras de sabre**

- Metal. *págs. 249 - 250*
- Madeira. *págs. 251 - 252*
- S-Express. *pág. 252*
- Madeira + Metal. *págs. 253 - 254*
- Especiais. *págs. 254 - 255*
- JR100D e DJR183. *pág. 256*
- Folhas para 2107FK / 2107FKX. *pág. 257*
- DPB181 e DSD180. *pág. 258*
- Aces. para LB1200. *pág. 259*
- Aces. para 2107FK. *pág. 260*



**12. Serras tico-tico**

- Super Express. *pág. 264*
  - Madeira:
    - Corte básico. *pág. 264*
    - Corte rápido. *pág. 265*
    - Laminadas. *pág. 265*
    - Corte limpo. *pág. 266*
    - Madeiras duras. *pág. 266*
    - Com prego. *pág. 267*
- Metal. *pág. 267*
- Especiais. *pág. 268*
- Conjuntos de folhas a granel. *pág. 269*
- Inserção Makita. *págs. 270 - 271*
- Grampos, guias e adaptadores. *pág. 272*



**13. Fresagem**

- Madeira. *págs. 275 - 278*
- Furar alumínio. *pág. 279*
- 3706, DCO180 e DCO181. *pág. 279*
- PJ7000 e 3901. *pág. 280*
- 7104L. *pág. 280*
- Vários. *págs. 281 - 282*
  - Casquilhos.
  - Porcas.
  - Chaves.
- Guias. *págs. 283 - 284*
  - Modelo.
  - Carril.
- RT0700C. *págs. 285 - 286*



**14. Decapar**

- Boquilhas. *págs. 287 - 288*



**15. Parafusos e pregos**

- Fitas de parafusos para auto alimentador. *pág. 291*
- Pregos: *págs. 292 - 293*
  - DPT351 e DPT353 - 0,6mm.
  - AF506 e DBN500 - 1,2mm.
  - AN250HC - Multimaterial.
  - GN420C - Multimaterial.
  - Carregador de pregos - GN420C.
- Grampos. *pág. 293*
- Vários. *pág. 294*



**16. Aspiração**

- Acessórios para aspiradores. *págs. 298 - 306*
  - Tubos:
    - Flexíveis.
    - Curvos.
    - Retos.
  - Pés.
  - Bocais.
- Filtros. *pág. 307*
- Sacos. *pág. 307*
- Acessórios para aspiradores de mão. *págs. 308 - 309*
- Acessórios para aspirador de pé e portátil. *págs. 310*
- Acessórios para aspiradores de mochila e robôs aspiradores. *pág. 311*
- Vários. *pág. 314 - 318*



**17. Níveis**

- Vários. *págs. 319 - 322*



**18. Roedoras, tesouras e puncionadoras**

- JN1601, JN3201, JS8000 Vários. *pág. 324*
- Lâminas para DJS200. *pág. 325*
- Acessórios para DPP200. *pág. 325*
- Acessórios para puncionadora DPP200. *págs. 326*



**19. Jardim**

- Barras, correntes, capas e acessórios para motosserras e corta-sebes. *págs. 330 - 332*
- Acessórios pistola de ar AS001G. *pág. 333*
- Aces. para sopradores. *págs. 334 - 335*
- Aces. para corta-sebes e corta-relvas. *pág. 336 - 337*
- Aces. para UX001G / DUX60 / DUX18. *pág. 338 - 339*
- Discos e cabeças para roçadoras. *pág. 341*
- Cabeçote e fios de nylon. *págs. 342 - 344*
- Óleos. *pág. 345*
- Arneses e proteções para roçadoras. *pág. 346*
- Aces. para perfuradora DDG460. *pág. 347*
- Brocas para solo 3/4". *pág. 348*
- Aces. para DUC122 e UC120D. *pág. 348*
- Aces. para tesouras de poda. *pág. 349*
- Acessórios para carros de transporte DCU603, DCU604, DCU605 e DCU180. *pág. 350 - 351*
- Lavadoras de alta pressão. *págs. 352 - 354*



**Makita. Recomendações de segurança.****Importante**

- Ao utilizar ferramentas elétricas, as recomendações básicas de segurança devem ser sempre seguidas para reduzir o risco de incêndio, choque elétrico e ferimentos pessoais, tais como as indicadas a seguir.

**Mantenha a área de trabalho limpa**

As áreas e mesas de trabalho desorganizadas podem provocar lesões.

**Tenha em conta o ambiente de trabalho**

Não utilize ferramentas elétricas em ambientes húmidos ou molhados. Mantenha a área de trabalho iluminada. Não exponha ferramentas elétricas à chuva. Não utilize ferramentas elétricas na presença de líquidos ou gases inflamáveis.

**Mantenha as crianças afastadas**

Todos os visitantes devem manter-se afastados da área de trabalho. Não permita que os visitantes toquem na ferramenta ou nos cabos de extensão.

**Guarde as ferramentas num local apropriado**

Quando não estiverem a ser utilizadas, as ferramentas devem ser guardadas num local seco e a uma altura que as mantenha fora do alcance das crianças.

**Não force a ferramenta**

A ferramenta realizará melhor seu trabalho e de forma mais segura ao ritmo para o qual foi projetada.

**Use a ferramenta apropriada**

Não force ferramentas pequenas ou acessórios para realizar o trabalho de uma ferramenta maior. Não utilize ferramentas para fins para os quais não foram concebidas.

**Vista-se de forma adequada**

Não use roupa solta ou joias. Podem ser presas entre as partes móveis. O uso de luvas de borracha e calçado antiderrapante é recomendado para trabalhos ao ar livre.

**Faça o uso adequado do cabo**

Nunca mova a ferramenta pelo cabo nem a puxe para desconectá-la da tomada. Mantenha o cabo afastado do calor, óleo e ângulos afiados.

**Trabalhe em segurança**

Use abraçadeiras para sustentar o trabalho. É mais seguro do que usar a mão para sustentá-lo e permite-lhe utilizar a ferramenta com ambas as mãos.

**Não ultrapasse os limites**

Mantenha-se sempre seguro e em equilíbrio.

**Mantenha as ferramentas com cuidado**

Mantenha as ferramentas de corte afiadas e limpas para uma utilização mais segura e eficaz. Siga as instruções sobre lubrificação e troca de acessórios. Inspeccione periodicamente o cabo da ferramenta e, se estiver danificado, repare-o num centro de serviço autorizado. Inspeccione periodicamente os cabos de extensão e substitua-os se estiverem danificados. Mantenha os cabos secos, limpos e livres de gordura e óleo.

**Desligue as ferramentas**

Quando não estiver a ser usadas, antes de as usar e ao trocar acessórios, como lâminas.

**Remover chaves de ajuste e inglesas**

Tenha o hábito de verificar se retirou as chaves de ajuste ou inglesas que tenha usado para ajustar a máquina antes de a ligar.

**Evite o arranque acidental**

Não transporte uma ferramenta ligada com um dedo no interruptor. Ao ligar, certifique-se de que o interruptor está na posição OFF.

**Use extensores no exterior**

Ao utilizar a ferramenta ao ar livre, utilize apenas cabos de extensão destinadas a este uso.

**Esteja atento**

Observe o que está a fazer. Utilize o bom senso. Não use a ferramenta quando estiver cansado.

**Verifique se há peças danificadas**

Antes de continuar a utilizar a ferramenta, as proteções ou qualquer peça que se encontre danificada devem ser verificadas para determinar se funcionam corretamente e cumprem a sua finalidade. Verificar o alinhamento e o deslocamento dos elementos móveis, rufuras, montagem e qualquer outra condição que possa prejudicar o seu funcionamento. Os protetores ou qualquer outra peça danificada devem ser substituídos ou reparados por um centro de serviço autorizado, salvo indicação em contrário no seu manual de instruções. Substitua os seus interruptores num centro de serviço autorizado. Não utilize a ferramenta se o interruptor não a ligar ou desligar.

**Proteja-se contra choques elétricos**

Evite o contacto direto do corpo com superfícies com ligação à terra (por exemplo, tubos, radiadores, frigoríficos, etc.).

**Peças sobressalentes**

Utilize apenas peças sobressalentes idênticas à peça original.

**Aviso de tensão**

Antes de ligar a ferramenta a uma fonte de alimentação. Certifique-se de que a tensão fornecida é idêntica à tensão indicada na placa de identificação da ferramenta. Uma tensão superior à especificada na ferramenta pode causar DANOS SÉRIOS ao operador, bem como à própria ferramenta. Em caso de dúvida, NÃO LIGUE COM A FERRAMENTA. A utilização de uma fonte de alimentação com uma tensão inferior à indicada é prejudicial para o motor.

**NOTA**

A Makita reserva-se o direito de alterar as especificações das ferramentas, equipamento básico e acessórios sem aviso prévio. O equipamento básico e as especificações das peças podem variar de país para país. A cor padrão de fábrica é Azul Industrial Makita. Por favor, indique a tensão necessária em cada encomenda. Estas ofertas estão sujeitas à disponibilidade em cada país. A cor dos produtos pode variar ligeiramente em relação à cor mostrada neste catálogo. É sempre recomendável completar as informações contidas neste catálogo por telefone ou correio eletrónico.

**Garantia Makita****Garantia**

Todas as ferramentas Makita passam por um rigoroso processo de inspeção e teste antes de sair da fábrica. Eles são garantidos contra defeitos de fabrico e/ou materiais. Se ocorrer algum problema, por favor, envie a ferramenta COMPLETA à Makita ou entregue-a no seu ponto de venda habitual. Se após a inspeção se demonstrar que o problema se deve a uma falha de fabrico/material, todas as reparações necessárias serão efetuadas sem custos. A garantia não cobre reparações efetuadas por terceiros; reparações devidas ao desgaste normal; uso indevido da ferramenta ou queda acidental; utilização manifestamente incorreta - causada por sobrecarga da ferramenta para além da sua capacidade, utilização da ferramenta após uma avaria parcial ou utilização com acessórios inadequados.



## Riscos e desvantagens da utilização de falsificações

### **ATENÇÃO:** Makita informa

- Infelizmente o crescimento das compras online criou espaço para oportunistas que procuram tirar partido do consumidor a todo custo. Produtos que são imitações são cada vez mais comuns na Internet, particularmente através de leilões em que o vendedor é anónimo e a sua utilização pode levar a sérios problemas. A seguir explicamos as principais características para diferenciar as nossas ferramentas e acessórios originais:



#### **Logótipo Makita**

O logótipo Makita deve ser moldado diretamente na caixa da ferramenta e com o símbolo de marca registada ®.



#### **Etiqueta**

As etiquetas Makita devem corresponder ao modelo e às especificações da ferramenta que ostenta a etiqueta. Etiquetas falsas muitas vezes têm o nome do modelo em minúscula.



#### **Acabamento**

O acabamento das ferramentas Makita é metal polido. As contrafações são frequentemente lacadas para dar a aparência deste brilho.



#### **Componentes**

Os componentes das ferramentas Makita são sempre de qualidade superior, mais duráveis e de melhor material.



#### **Packaging**

As caixas de cartão ou caixas em que as ferramentas Makita são embaladas são de maior qualidade e protegem melhor o produto, já que se adaptam melhor ao modelo que contêm.

#### **Componentes**

Ao registar a ferramenta em [www.makita.pt](http://www.makita.pt), a Makita concede até três anos de garantia em todos os seus modelos. Dentro da caixa encontrará a prova desta garantia, que as falsificações não terão.

## **ATENÇÃO: UTILIZE BATERIAS ORIGINAIS**

### **Segurança**

Em muitos casos, os produtos falsificados não foram fabricados e testados de acordo com os padrões de qualidade e segurança exigidos por lei. Estes riscos incluem o perigo de danos ao produto em resultado de vazamento ou superaquecimento da bateria a tal ponto que a bateria pode incendiar-se.

### **Qualidade**

Não é possível garantir o correto desempenho de uma bateria falsificada. Existem baterias não genuínas no mercado que afirmam ter o mesmo Ah que as baterias Makita, mas que são significativamente menos potentes. Uma bateria Makita original também incluirá um chip incorporado que otimiza a vida útil da bateria.

### **Como identificar baterias falsas**

Ao comprar produtos é importante reconhecer aqueles sinais de aviso que indicam que o produto é original. Recomendamos comprar em revendedores autorizados Makita em Espanha e ter cuidado com os vendedores com preços involuntariamente baixos.



***Graças aos aspiradores Makita,  
terá um espaço limpo e seguro.***

O filtro HEPA remove mais de 99,75 %  
das partículas no ar.



**HEPA**  
*filter*



# Baterias de mochila

## 18Vx2 LXT / 36V / 40Vmax 33,5Ah

Até seis vezes mais tempo de funcionamento com ferramentas de 18Vx2 LXT e 6,0Ah.



**PDC1200A01\***  
**PDC1200A02**

**LXT** 18Vx2 LXT → 36V **XGT** 40Vmax



\* Inclui adaptador 18Vx2 LXT



- O arnês de libertação rápida permite o uso desta bateria como uma fonte de alimentação fixa.
- Interruptor de alimentação principal com função de desligamento automático.



Ajuste da altura da bateria para maior conforto do utilizador.



Indicador de carga de bateria de 4 LED.

**PDC1200A01\*** **PDC1200A02**

**1.984,00 €**

**1.863,00 €**

- O modelo PDC1200 é uma bateria com uma capacidade de 1200 Wh, 33,5 Ah e uma tensão entre 36 V e 40 V máx. (aproximadamente).
- Até 2,8 vezes mais tempo de duração do que a nossa mochila porta-baterias PDC01 carregada com quatro baterias de 18 V LXT 6,0 Ah (BL1860B).
- Compatível com três plataformas: 18 V x 2 LXT (adaptador opcional), ligação de alimentação direta de 36 V e com 40 V máx. XGT (adaptador opcional).
- Bateria não compatível com aspiradores, tesouras de poda, motosserras exceto modelo DUC355 e modelos 40 V max. XGT, serra circular DHS710 e martelo leve série DHR280.
- Graças à estrutura do arnês, a bateria pode ser mantida verticalmente no chão.

# CONSTRUÇÃO DA BATERIA

Muito duradoura e resistente. Especialmente concebida para trabalhos de exigência máxima.



Paredes protetoras.  
Protegem os terminais  
da água e do pó.

Quatro LEDs.  
Indicador de carga.

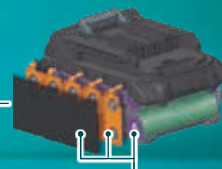
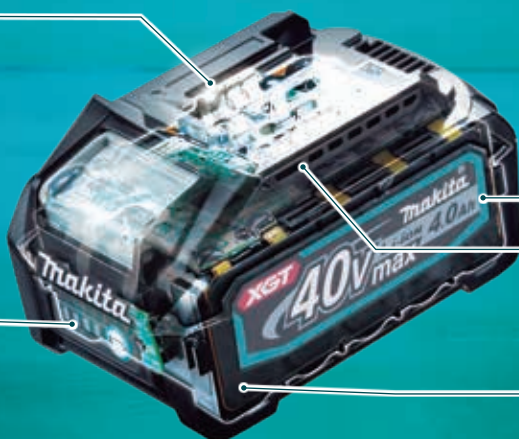

Camada tripla impermeável.



Calhas rígidas de grande  
durabilidade.



Espaço entre as células e o invólucro  
para proteger a bateria de impactos.

**Gama 40V máx**



**Lítio-ion**



**Ao registar a sua ferramenta online,  
alargará a garantia até ao máximo de  
três anos a contar da data de compra.**

**[www.makita.pt](http://www.makita.pt)**





**XGT** é um sistema criado e desenvolvido pela Makita com as suas ferramentas, baterias e carregadores.

Uma combinação de ferramentas inovadoras. O design e as baterias **MAIS POTENTES** proporcionam uma solução genuína para utilizadores industriais de elevada exigência.



## BATERIA DE ELEVADA POTÊNCIA

XGT é uma solução genuína para as aplicações industriais de elevada exigência, sendo uma combinação de design inovador das ferramentas e elevada potência das baterias.



## TECNOLOGIA INTELIGENTE

A gama de ferramentas e baterias XGT com programa incorporado, que proporciona uma comunicação digital entre a bateria e a ferramenta em ambos os sentidos.



## DURABILIDADE

XGT é uma tecnologia duradora e de elevada resistência, concebida para trabalhar em condições meteorológicas adversas.



## PRONTA PARA O FUTURO

XGT e LXT irão conviver para proporcionar aos utilizadores uma gama sem concorrência de elevada performance e para todas as necessidades profissionais.



### Características

A gama de ferramentas e baterias XGT dispõe de um chip incorporado, que proporciona comunicação digital entre a bateria, a ferramenta e o carregador. A tecnologia das baterias e a engenharia de motores trabalham em conjunto de uma forma otimizada.

As baterias têm calhas rígidas que as mantêm firmemente no lugar quando são utilizados os novos produtos de alta potência.

Paredes protetoras. Protegem os terminais da água e do pó.

Indicador de carga com quatro LED's situados na parte da frente da bateria para facilitar a sua recarga.

O robusto carregador de 40V máx carrega as baterias em apenas 28 minutos (BL4025).

Um acessório adaptador de carregamento que permite carregar produtos LXT e XGT (mais de 320 no total).

# Sistema de carregamento inteligente

## Carregador rápido

Se a temperatura da bateria for elevada, é necessário que esta arrefeça antes de se iniciar o carregamento. O ventilador incorporado faz circular o ar através da bateria antes de começar a carregar e durante o processo de carregamento para arrefecê-la. Desta forma, o tempo de carregamento é menor.

### Sistema de carregamento inteligente.

Arrefecimento por ar forçado.



### Sistema de carregamento geral.

Arrefecimento natural.



### Carregamento rápido.



### Maior tempo de espera para carregar.



O carregador rápido da Makita comunica com o chip incorporado da bateria durante todo o processo de carregamento para otimizar a vida útil da bateria, controlando ativamente a corrente, a tensão e a temperatura.



### Carregamento inteligente

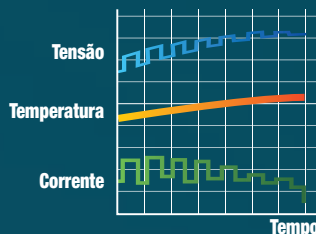

### Carregamento geral

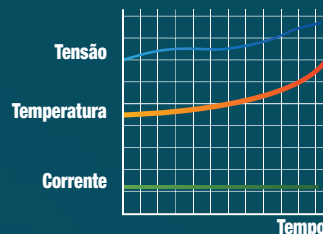

## Proteção da bateria



Sobredescarregamento

Sobrecarregamento

Estado de alta temperatura

Sobrecarregamento

Esta função é a tecnologia de comunicação que permite à ferramenta e à bateria monitorizarem as condições e trocarem dados em tempo real. Desta forma, a bateria é protegida contra o sobrecarregamento e sobreaquecimento.

**Carregamento em qualquer momento.**  
Sem efeito de memória. Não é necessário descarregar.



**Muito resistente.**  
Invólucro rígido.

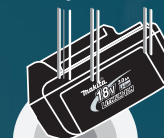

**Longa duração.**  
Baixo autodescargamento.



**Comunicação constante entre ferramenta e bateria**



## 40% mais leve



**Makita**  
18V Lítio-Ion 5,0Ah  
14,4V Lítio-Ion 5,0Ah

**Makita**  
18V / 14,4V  
Ni-Mh 2,8Ah



### Terminais multi-contacto

Reduzem a resistência elétrica e aumentam a estabilidade da ligação. Resistentes contra as vibrações e, em última instância, garantem um fornecimento de corrente estável à ferramenta.

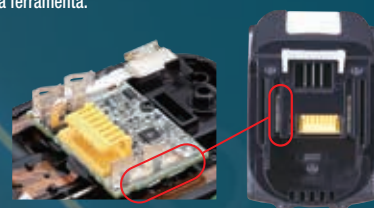

**18V**  
LITIO-ION

**LXT**  
Lítio-ion EXTREMA TECNOLOGIA

**Mais de  
360 modelos  
com a mesma  
bateria**



## Fácil de usar



**Colocação em funcionamento.**



Necessitam de mais tempo para começar.



Funcionam assim que a bateria é inserida e a máquina é ligada.

**Controle de velocidade constante.**

**Ferramentas a gasolina**

**Ferramentas a bateria**



Mais difícil de manter uma velocidade de rotação constante.



A Velocidade de rotação constante é mantida.

**Baixo ruído.**

comparação do nível de ruído.

**Ferramentas a gasolina**

**Ferramentas a bateria**



=



**Vantagens da bateria**

## Fácil limpeza e manutenção



**Sem emissões.**

**Ferramentas a gasolina**

**Ferramentas a bateria**



Libertam gases do escape.



**Redução de custos e tempo.**

**Ferramentas a gasolina**

**Ferramentas a bateria**



Leva tempo a preparar a mistura de combustível para o motor.



Basta ligar a bateria à máquina e está pronta a usar.

**Fácil manutenção.**

**Ferramentas a gasolina**

Requer manutenção.



Lubrificante. Filtro de ar. Vela.

Tampa do combustível.

**Ferramentas a bateria**

Não requer manutenção.



**Armazenar por muito tempo.**

**Ferramentas a gasolina**

Se armazenar a máquina com combustível no interior durante muito tempo, pode causar problemas no motor. Antes de armazenar a máquina, retire o combustível.



**Ferramentas a bateria**

Se guardar a máquina durante muito tempo, poderá utilizá-la imediatamente após a inserção da bateria.



# Acessórios ideais para ferramentas a bateria



**Proporcionam o melhor desempenho nas ferramentas a bateria!**

Mais velocidade, mais trabalho com uma única carga de bateria completa e uma boa sensação de uso.

Os acessórios recomendados para ferramentas sem fio podem ser encontrados sob os símbolos acima.

**Experimente e veja a nossa vasta gama de acessórios Makita!**





*Impact*  
**PREMIER**



**Maior precisão de ajuste.**

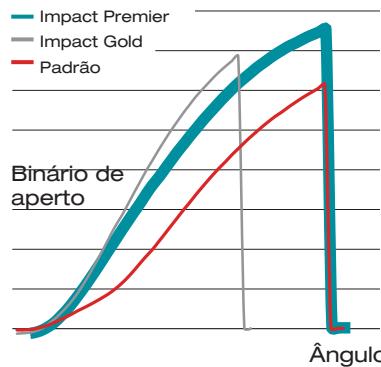
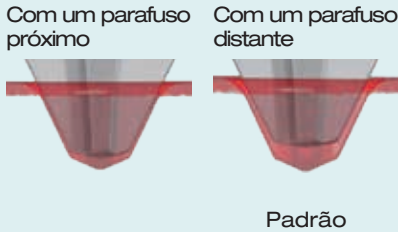
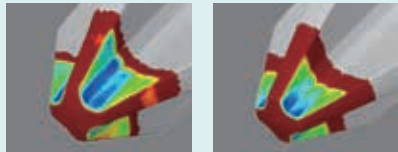

**Dupla torção para maior durabilidade.**



**Serra de sabre de dente japonês**



**Dentes japoneses de 0,6 mm de espessura para um corte mais limpo do material.**

**Serra de dente japonês:**

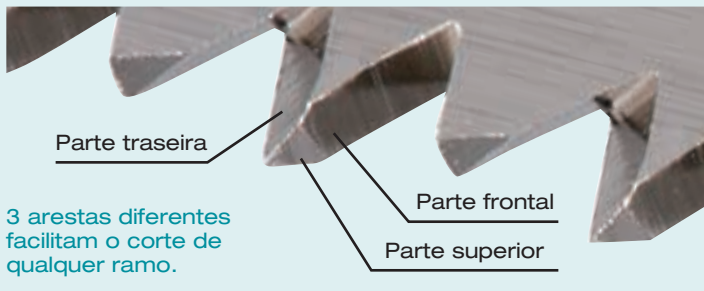

**Qualidade superior**



Acabamento com dente japonês



Acabamento com dente normal



**Fio de nylon de quatro folhas**

**Quatro folhas**

**O formato de quatro folhas reduz o ruído e aumenta o tempo de trabalho.**



**Características**

A forma do fio de quatro folhas cria um pequeno vértice que reduz o ruído de corte e prolonga o tempo de trabalho devido à menor resistência.

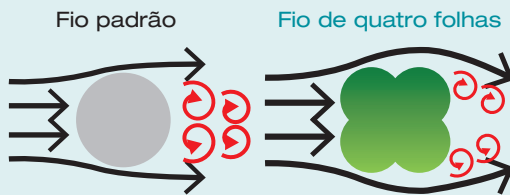

**Número de cortes por carga**

**120** **20% mais**  
**100**



**Ruído**

**90,5dB** **6,5dB menos**  
**97dB**



**Corrente para motosserra série 80**



**Características**

Forma de corte ideal para um corte suave

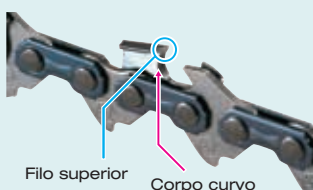

Passo de corrente curto para reduzir a vibração

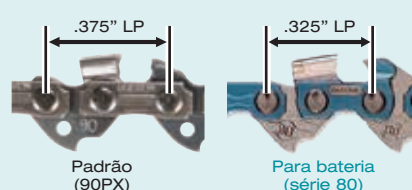

**Vibração**

**85** **15% menos**  
**100**

**Número de cortes por carga**

**125** **20% mais**  
**100**



## Brocas de coroa

# Ezychange

- BI-Metal HSS 8%Co
- TCT



### Mudança com um clique

Brocas de coroa facilmente intercambiáveis

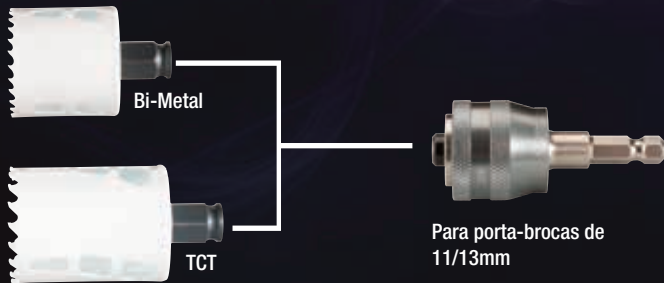

### Fácil de limpar e remover pedaços de madeira

Simplesmente inserindo uma broca reta no interior.



Com barra de extensão (150/300mm)

Para porta-brocas de 13mm

## Ezychange

### BI-Metal HSS 8%Co

Tamanho variável para corte mais rápido

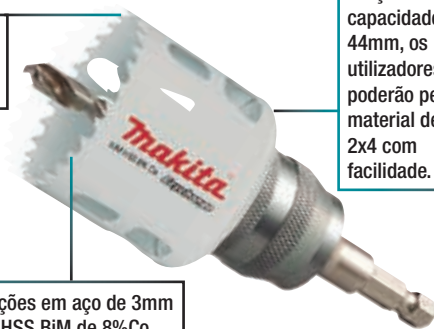

Graças à capacidade de 44mm, os utilizadores poderão perfurar material de 38mm 2x4 com facilidade.

Pode fazer perfurações em aço de 3mm de espessura com HSS BiM de 8%Co

## Ezychange

### TCT

TCT de alta durabilidade

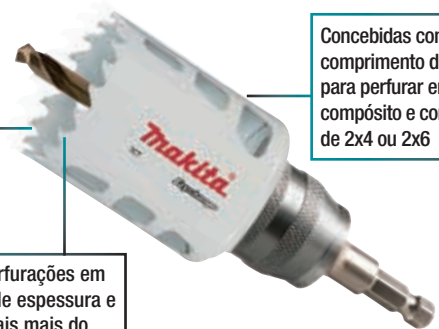

Concebidas com um comprimento de 60mm para perfurar em composto e contraplacado de 2x4 ou 2x6

Pode fazer perfurações em aço de 3mm de espessura e outros materiais mais do que BiM de TCT

### Broca de coroa BiM



Adaptador padrão

Tamanho variável para corte mais rápido

HSS Bi-Metal

### Broca de coroa TCT







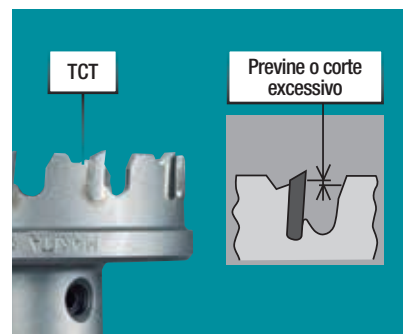

TCT

Previne o corte excessivo



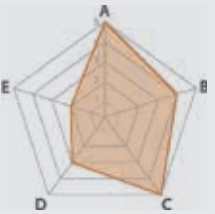
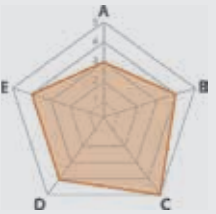

## Brocas T.C.T para martelos SDS-Plus

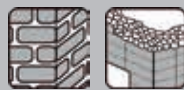
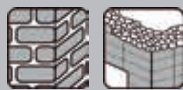
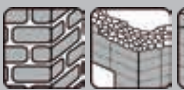
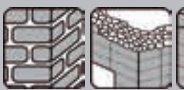





Produto	Standmak	V-Plus	SDS-V-Plus Mak 4	NEMESIS
Categoria	★★	★★★★	★★★	★★★★★
Ponta				
Tipo	Pastilha de 2 cortes	Pastilha de 2 cortes	Pastilha de 4 cortes	Pastilha sólida de 4 cortes
Espiral	Espiral dupla padrão	Espiral dupla de alta durabilidade	Espiral dupla padrão	Espiral quádrupla de alta durabilidade
Tamanho	3,5 - 30mm	3,5 - 26mm	5 - 25mm	5 - 32mm
Equilíbrio de propriedades				
Material de trabalho				

A- Velocidade  
 B- Vida útil  
 C- Posicionamento fácil  
 D- Precisão  
 E- Anti-quebra de rebarbas

## Brocas T.C.T para martelos SDS-Max

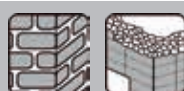

A pastilha sólida de 4 cortes só está disponível para brocas até de 16mm Ø

Produto	Standard	Mak 4
Categoria	★★	★★★
Ponta		
Tipo	Pastilha de 2 cortes	Pastilha de 4 cortes
Espiral	Espiral dupla padrão	Espiral dupla padrão
Tamanho	12 - 40mm	12-30mm
Equilíbrio de propriedades		
Material de trabalho		

A- Velocidade  
 B- Vida útil  
 C- Posicionamento fácil  
 D- Precisão  
 E- Anti-quebra de rebarbas





Serras circulares TCT EFFICUT



**EFFICUT**



**Características**

Eficiente  
Ângulo superior agudo



Eficiente  
Corpo curvo



Eficiente  
Base retificada



**Número de cortes por carga**

100

**140% mais**

**240**



**EFFICUT Composite**

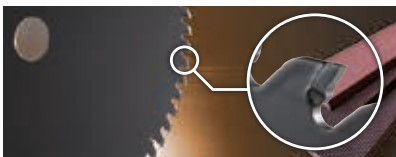

**Características**

Eficiente  
Base retificada



Eficiente  
Corpo curvo



**Número de cortes por carga**

100

**30% mais**

**130**



**EFFICUT Metal**

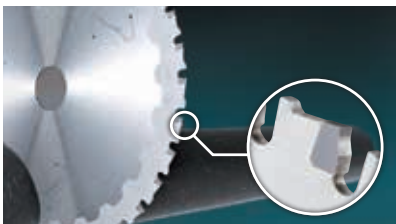

**Características**

Reduz as rebarbas  
Maior robustez



Corte mais suave  
Reduz o ruído e a vibração



Maior produtividade  
Superior em corte reto

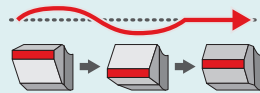

**Número de cortes por carga**

100

**60% mais**

**160**



**EFFICUT Alumínio**

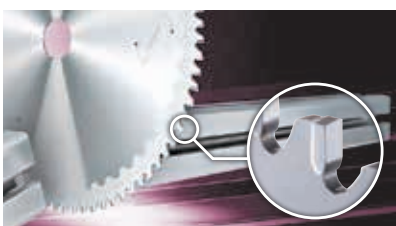

**Características**

Reduz as rebarbas  
Maior robustez



Corte mais suave  
Reduz o ruído e a vibração



Maior produtividade  
Superior em corte reto

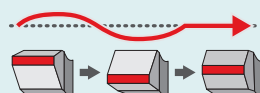

Optimização do trabalho  
Menor resistência ao corte



**Número de cortes por carga**

100

**40% mais**

**140**



**Disco de diamante segmentado**  
Ideal para cortadores a bateria

Os diamantes são distribuídos na estrutura do segmento, alcançando uma maior eficiência de trabalho.  
Ranhurinhas mais estreitas, maior capacidade de corte.

**Número de cortes por carga**

100

**65% mais**

**165**



**Disco abrasivo para metal**  
Ideal para cortadores a bateria

Mistura ideal de grão abrasivo e aglutinante para cortadores a bateria.

**Número de cortes por carga**

100

**10% mais**

**110**

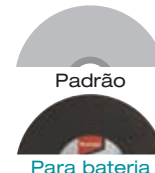



0,8mm



### Disco de corte fino

0,8mm de espessura para um corte mais rápido

#### Espessura reduzida

Corte rápido / menos resistência ao corte / melhor acabamento / menos produção de pó



Padrão  
1mm de espessura



Para bateria  
0,8mm de espessura

Número de cortes por carga

100

120

20% mais

1,4mm

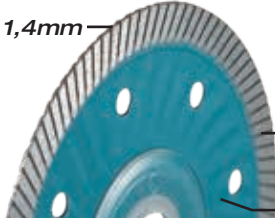

### Disco de diamante seg.

Corte suave e preciso

#### Espessura reduzida sem perda de força

Com 1,4 mm, consegue um corte suave e preciso.

Com um interior corrugado para aumentar a tensão e reduzir as vibrações durante o corte.

Para azulejos



Padrão  
2,3mm de espessura



Para bateria  
1,4mm de espessura

Número de cortes por carga

100

160

60% mais

1,6mm

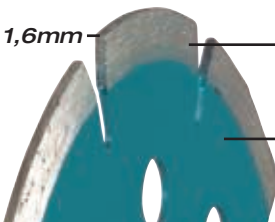

#### Especial para trabalhos de corte

Com 1,6 mm, corta de forma suave e precisa em betão ou pedra.

O corpo do disco é mais leve do que os modelos anteriores, facilitando o corte e aumentando o tempo de utilização com uma bateria totalmente carregada.

Para betão/pedra



Padrão  
2,2mm de espessura



Para bateria  
1,6mm de espessura

Número de cortes por carga

100

150

50% mais

## XLOCK

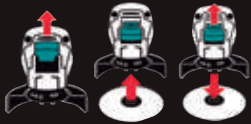

Disco de corte fino

Disco de diamante

Disco de rebarbar



### Troca rápida

Aumenta a velocidade de troca de acessórios sem peças intercambiáveis.



### Sem ferramentas

O disco pode ser trocado sem a necessidade de ferramentas externas.



2,5mm



### Disco abrasivo para metal

Especial para cortadoras

#### Espessura reduzida e aglutinante ideal

Disco de 2,5mm de espessura para um corte suave e rápido. Com um ótimo aglutinante para aumentar a vida útil do disco.



Padrão  
3mm de espessura



Para bateria  
2,5mm de espessura

Número de cortes por carga

100

130

30% mais



**Discos abrasivos de rebarbadora**

**Novo design**

**Pictogramas de segurança** (Safety pictograms)

**País de origem** (Country of origin): Made in China

**Código** (Code): D-74491

**Tamanho** (Size): 125x6x22.23mm (5" x 1/4" x 7/8")

**Instruções (ver ponto 1)** (Instructions (see point 1))

**Aplicação (ver ponto 4)** (Application (see point 4))

**Especificações (ver ponto 3)** (Specifications (see point 3))

**Padrão** (Standard): EN12413

**Máxima velocidade de trabalho** (Maximum working speed): max. 80m/s (4800 m/min) / max. 12250min<sup>-1</sup> (12250rpm)

**Classificação (ver ponto 2)** (Classification (see point 2))

**Metal** (Metal)

**T27 A24P-BF**

**EN12413**

**Makita Corporation** www.makita.com

**Economic Operator in EU/UK:** Makita-Jarn-Baptist Vynskratz 2.3070, Belgium/Makita (UK) Ltd, MK15 8JN, UK

**Made in China**

**Barcode:** 0 88381 58771 6

**Ponto 1** *O ícone mostra a utilização correta*

	Para metal	Para INOX	Para tijolo / alvenaria	Para alumínio
Rebarbar				
Para corte em rebarbadoras				
Para corte em cortadoras			-	
Para corte em cortadoras		-		-

## Discos abrasivos de rebarbadora

**Ponto 2** As marcas referem-se à categoria e qualidade



Rendimento



Qualidade

**Ponto 3** Especificações

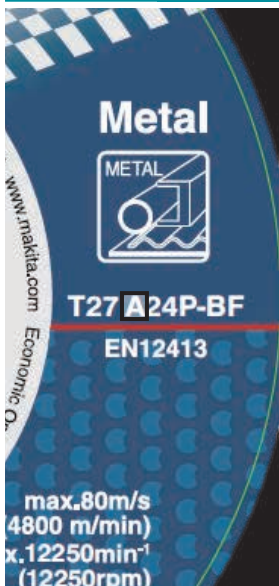

### Óxido de alumínio (principalmente para metal e INOX)

#### Alumínio fundido castanho: A

O material mais comum em abrasivos metálicos.



#### Óxido de alumínio simples: SA

Abrasivo de cristal simples com alta durabilidade. Maior desempenho para cortar/rebarbar do que A.



#### Óxido de alumínio branco: WA

Material abrasivo de alta pureza. Maior desempenho para cortar/rebarbar do que A.



#### Zircônio: Z

Material abrasivo muito afiado e duro. Maior desempenho para cortar/rebarbar do que SA.



#### Cerâmico:

Material abrasivo muito afiado, altamente durável, resistente ao impacto/calor. Abrasivo de alta qualidade para corte/rebarbar com maior desempenho.



### Óxido de silício (principalmente para materiais não metálicos)

#### Carboneto de silício negro: C

O material abrasivo mais comum para materiais não metálicos.



#### Carbeto de silício verde: GC

É de pureza superior ao C, alcançando um desempenho superior, mas ao mesmo tempo uma durabilidade inferior.



### Tamanho do grão

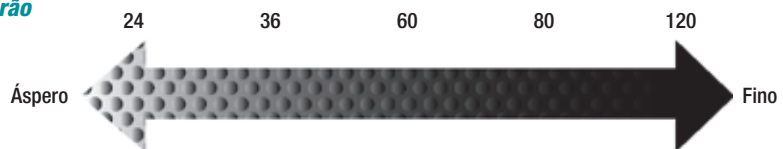

### Dureza abrasiva

Quanto mais próximo de A, mais suave. Quanto mais próximo de Z, mais duro.

Abrasivo macio ▶ Material duro  
Abrasivo duro ▶ Material macio

Muito macio	Macio	Médio	Duro	Muito duro
A - G	H - K	L - O	P - S	T - Z







### Tipo de resina

BF: Resina reforçada  
V: Resina vitrificada

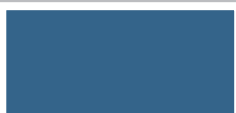

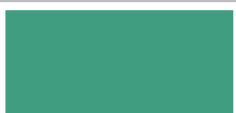
**Ponto 4** A cor indica o tipo de aplicação

	Para metal	Para INOX	Para tijolo / alvenaria	Para alumínio
Cor	 Azul	 Laranja	 Verde	 Cinzento

## Discos de lâminas de rebarbadora

Novo design



### Ponto 1 *O ícone mostra a utilização correta*

	Para metal	Para INOX	Para tijolo / alvenaria
Rebarbar			

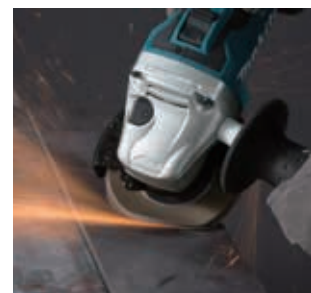

### Ponto 2 *As marcas referem-se à categoria e qualidade*



Rendimento Qualidade



### Ponto 3 *As marcas referem-se ao grão e dureza*



**Óxido de alumínio (principalmente para metal e INOX)**

**Alumínio fundido castanho: A**

O material mais comum em abrasivos metálicos.

**Zircônio: Z**

Material abrasivo muito afiado e duro. Maior desempenho para cortar/rebarbar do que SA.



**Óxido de silício (para materiais não metálicos)**

**Carboneto de silício negro: C**

O material abrasivo mais comum para materiais não metálicos.



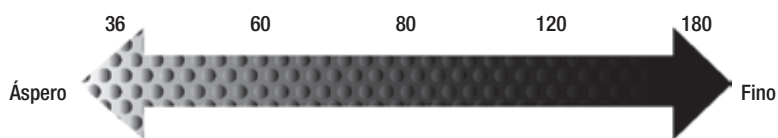

Tamanho do grão





## Discos de lâminas de rebarbadora

**Ponto 4** A cor indica o tipo de aplicação

	Para metal	Para INOX	Para tijolo / alvenaria
Cor	 Azul	 Laranja	 Verde

### Tipo de suporte



**Suporte de fibra de vidro**  
Suporte padrão.



**Suporte de nylon**  
Para trabalhos pesados.

### Inclinação das lâminas



**Plano**  
Para superfícies retas.













**Curvo**  
Para cantos ou ângulos.

### Tabela de materiais

\*Depois de ler o manual de instruções da rebarbadora, escolha o material de trabalho.

☆☆ Recomendado ☆ Possível

Descrição do material	Óxido de alumínio 	Zircônio 	Carboneto de silício 
Guia de cores e aplicação	 Ideal para trabalhos em metal	 Ideal para trabalhos em metal e INOX	 Trabalhos em tijolo / alvenaria
Plástico 	☆		
Metal 	☆☆	☆☆	
Não-metálicos 	☆	☆	
INOX 		☆	
Tijolo / alvenaria 			☆☆



## Serras de sabre

### Tipos de dentes

#### Dente alternado fresado

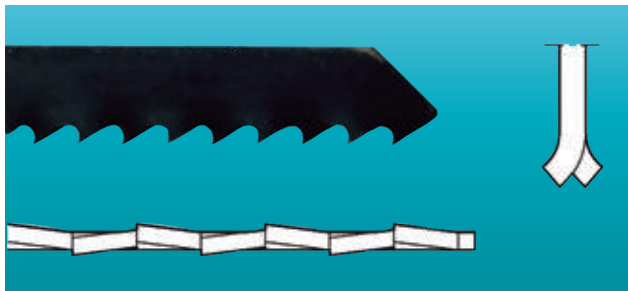

#### Dente alternado prensado

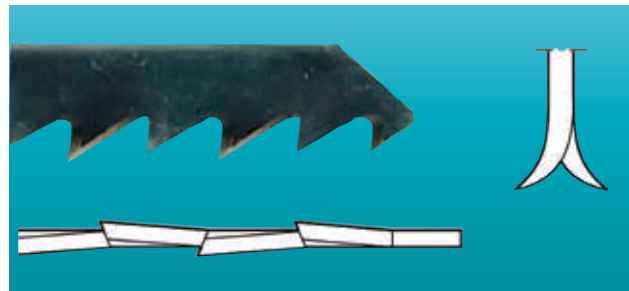

#### Dente ondulado fresado

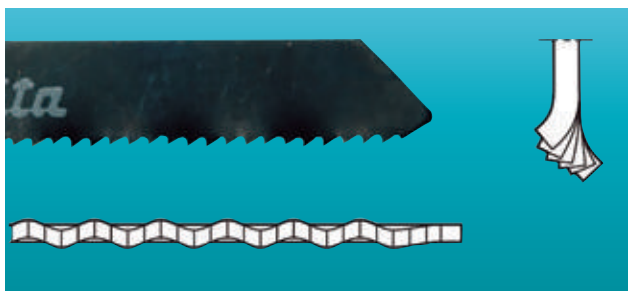

#### Dente reto prensado

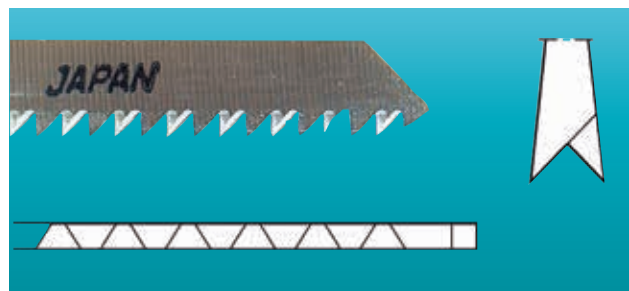

### Fabrico dos dentes

#### Dentes fresados

- Redução dos custos de fabrico
- Para cortes gerais menos precisos
- Para corte de materiais macios e duros
- Longa vida útil da lâmina



#### Dentes prensados

- Custo de fabrico mais elevado
- Mais afiado
- Para cortes mais precisos
- Para corte de materiais macios e médios



### Método de fabrico

**Alternado:** Cada dente é dobrado para a direita ou para a esquerda manualmente, deixando um centrado depois. x: Esquerda, direita, centrado, etc.

**Ondulado:** Toda a fila de dentes é moldada para ter uma forma curva e ondulada.

**Reto:** A fila de dentes torna-se mais estreita e cónica.

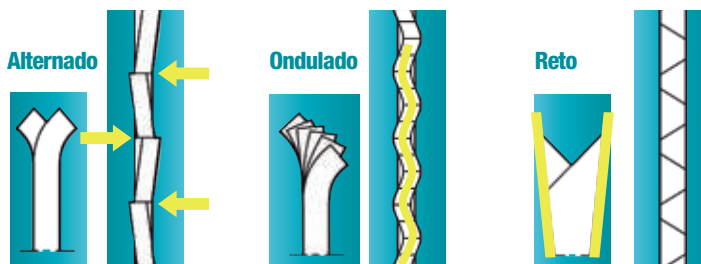

### Material das serras

**HCS (Aço alto teor de carbono):** Para cortar materiais mais macios, tais como madeira ou plástico.

**HSS (Aço alta velocidade):** Para cortar materiais mais duros, tais como metais.

**BiM (Bi-Metal, Base HCS e dentes HSS):** Combinando ambos os tipos de aço, podemos cortar tanto materiais macios como duros.

**TC (Carboneto de tungsténio):** Para cortar plástico reforçado com fibra de vidro, painel de fibra colado a cimento ou gesso cartonado.



**Makita**®

**40V**  
max

**XGT**

**18V**  
LITH-ION

**14.4V**  
LITH-ION

**LXT**  
EMERGENCY TECHNOLOGY

**12V**  
max  
LITH-ION

**CXT**



# FOLHETO DE ILUMINAÇÃO 2023

## Barra e corrente para motosserras

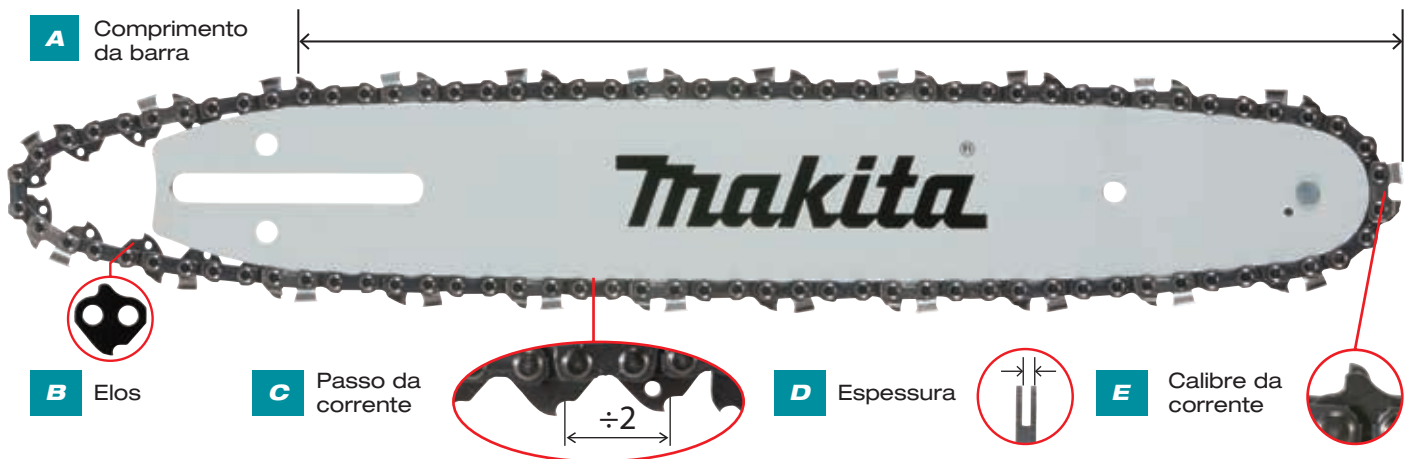

- A Comprimento da barra**  
O comprimento da barra da corrente refere-se ao seu comprimento de corte, que é diferente do comprimento total da barra.
- B Elos**  
O comprimento da corrente é determinado pelo número de elos que possui.
- C Passo da corrente**  
O passo da corrente é determinado pela distância entre três rebites consecutivos divididos por dois. A roda dentada da embraiagem e a roda dentada frontal devem ter o mesmo passo.
- D Espessura**  
A espessura da corrente deve caber dentro da barra, assim deve correspondê-la em largura.
- E Calibre da corrente**  
O calibre da corrente determina a profundidade de corte dos dentes da corrente. A profundidade de corte pode ser verificada pela distância entre a aresta de corte da roda dentada e o elo seguinte.

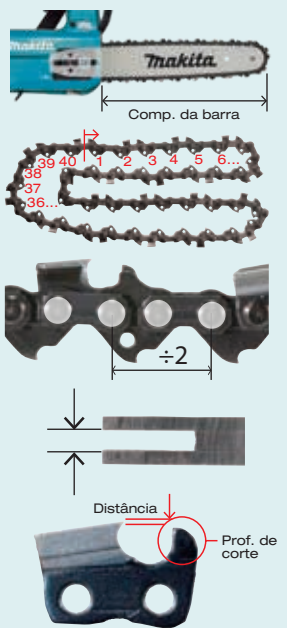

### Tipos de correntes

D Espessura	Velocidade de corte		
	Rápido		Lento
C Passo da corrente	0,043" (1.1mm)	0,050" (1.3mm)	0,058" (1.5mm)
Superfície	1/4"		25AP 25F
	.325" LP	80	
	3/8" LP	90PX	91PX 91F 91VXL
	.325"		20BPX 95VPX
			21BPX 21LPX
			73DPX 73LGX 73LPX

### Tipos de barra

#### Barras de estrela

Estas barras têm uma roda dentada rotativa na frente que faz a corrente mover-se com menos fricção ao longo da barra.



#### Barras blindadas

A ponta desta barra tem um reforço em estelita que a torna mais resistente, não tem roda dentada. Para aplicações especiais de alta resistência.



#### Barras carving

Estas barras são reforçadas com estelita e aço de alta qualidade. A parte da frente é mais fina para um corte mais preciso.

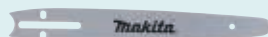

### Manutenção da barra e da corrente

#### Tensão da corrente

A corrente pode perder tensão após longos e contínuos períodos de funcionamento.



#### Rodas dentadas

Lime as arestas das rodas dentadas uma vez por semana para os manter num ângulo de 90°.



#### Limpeza da barra

Remover de vez em quando as aparas e o pó da barra da corrente.

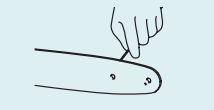

#### Nível de lubrificação

Verificar regularmente o nível de lubrificação das rodas dentadas para um melhor desempenho.



### Afiação de dentes da corrente

#### Lima redonda e suporte

A lima pode ser utilizada com maior precisão com uma guia. A guia tem marcações para determinar o ângulo ideal a 30° e limita a profundidade.

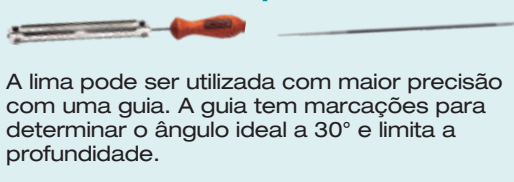





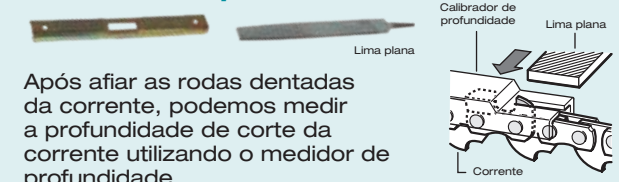







#### Calibrador de profundidade

Após afiar as rodas dentadas da corrente, podemos medir a profundidade de corte da corrente utilizando o medidor de profundidade.



**Tabela de tipos de cabeça e suas utilizações**

Tipo de cabeça / Utilização				
		Relva fina e curta	Relva comprida e grossa	Arbustos e árvores finas
Cabeça de nylon		←→		
Cabeça de polycut		←→		
Discos de metal			←→	
			←→	
			←→	
Disco corta-sebes			←→	
Triturador			←→	
Disco de serra				←→
Disco de cinzel				←→







## Conjuntos de malas de acessórios

Produto	Pcs.	Conteúdos							Código (inserção MZ)
		Brocas			Broca de coroa	Pontas	Escareador	Ferramenta manual	
		Metal	Madeira	Alvenaria					
<b>MAKPACK</b> ★ ★ ★ ★  As malas de acessórios MAKPACK reúnem brocas, pontas e ferramentas manuais numa caixa adaptada Makpack 1.	65	✓	✓	✓	-	✓	✓	✓	B-69478 (inserção tipo C)
	69	✓	✓	✓	-	✓	✓	-	B-49638
	87	-	-	-	-	✓	-	✓	E-11542
	96	✓	✓	✓	-	✓	✓	✓	B-49725
	116	✓	✓	✓	-	✓	✓	✓	B-49884
	120	-	-	-	-	✓	-	✓	E-08713
<b>MACCESS</b> ★ ★ ★ ★  As malas de acessórios MACCESS reúnem acessórios de alta qualidade para utilização profissional.	34	✓	✓	✓	-	✓	✓	-	D-36980
	71	✓	✓	✓	-	✓	✓	✓	D-33691
	104	✓	✓	✓	-	✓	✓	✓	D-31778
	200	✓	✓	✓	✓	✓	✓	✓	D-37194
<b>SQUARE</b> ★ ★ ★  Para utilizadores não profissionais.	17	✓	-	✓	-	✓	-	-	D-40200
	34	✓	✓	✓	-	✓	✓	-	B-68498

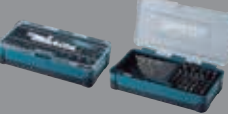

## Conjuntos de malas de acessórios

Produto	Pcs.	Conteúdos							Código (inserção MZ)
		Brocas			Broca de coroa	Pontas	Escareador	Ferramenta manual	
		Metal	Madeira	Alvenaria					
<b>KIT DE ACESSÓRIOS</b> ★ ★ ★  <p>Kits de acessórios em diferentes malas e tamanhos que incluem brocas, brocas de coroa, pontas, escareadores e ferramentas manuais.</p>	60	✓	✓	✓	-	✓	✓	-	E-11829
	100	✓	✓	✓	✓	✓	✓	-	B-54520
	102	✓	✓	✓	-	✓	✓	-	B-68432
		✓	✓	✓	✓	✓	✓	✓	E-10730
	212	✓	✓	✓	✓	✓	✓	✓	E-06270
	256	✓	✓	✓	✓	✓	✓	✓	E-11689
<b>FERRAMENTA MANUAL</b> ★ ★ ★  <p>Estes conjuntos contêm principalmente ferramentas manuais. Devido ao seu peso, são cobertos com plástico reforçado que é resistente a impactos ou quedas.</p>	76	-	-	-	-	✓	-	✓	E-10899
	87	-	-	-	-	✓	-	✓	E-08458
	120	-	-	-	-	✓	-	✓	E-06616
	221	-	-	-	-	✓	-	✓	E-10883
<b>ESTOJOS SDS-PLUS</b> ★ ★ ★ 	18	-	-	✓	-	✓	✓	-	E-07026
	29	✓	✓	✓	-	✓	-	-	E-07054
<b>ESTOJO</b> ★ ★ ★ 	17	✓	✓	✓	-	-	-	-	D-74887
<b>ESTOJO</b> ★ ★ ★ 	71	✓	✓	-	-	✓	-	-	B-50295



**GAMA DE EXTERIORES**  
OUTDOORS



# MELHORE A SUA EXPERIÊNCIA





**XGT** **40V** Li-ion  
max

**LXT**  
Litio-ion **EXTREMA TECNOLOGIA**

**CXT**

# Bateria



Baterias XGT, LXT, carregadores e compatibilidade de carregamento



CARREGADOR DUPLO / RÁPIDO

DC40RB  
191N09-8



276€

CARREGADOR / RÁPIDO

DC40RA  
191E07-8



171€

CARREGADOR / LENTO

DC40RC  
191M90-3



100€

Tempo de carga



**8,0 Ah**  
530€  
BL4080F  
191X65-8

76 min.

76 min.

170 min.

**5,0 Ah**  
336€  
BL4050F  
191L47-8

50 min.

50 min.

85 min.

**4,0 Ah**  
287€  
BL4040  
191B26-6

45 min.

45 min.

67 min.

**2,5 Ah**  
226€  
BL4025  
191B36-3

28 min.

28 min.

38 min.

**2,0 Ah**  
204€  
BL4020  
191L29-0

22 min.

22 min.

30 min.

18V Lítio-Ion



DC40RA  
191E07-8

171€

+



ADP10  
191C10-7

71€

Tempo de carga



**6,0 Ah**  
248€  
BL1860B  
197422-4

40 min.

**5,0 Ah**  
215€  
BL1850B  
197280-8

35\* min.

**4,0 Ah**  
182€  
BL1840B  
197265-4

29 min.

**3,0 Ah**  
154€  
BL1830B  
197599-5

22 min.

**2,0 Ah**  
121€  
BL1820B  
197254-9

24 min.

**1,5 Ah**  
100€  
BL1815N  
196235-0

15 min.

64V Lítio-Ion

Nova Bateria de 64V e 4,0Ah válida para LM001J



401€  
BL6440  
191R06-8

Tempo de carga

120 min.

DC64WA  
191W19-9

166€\*\*









\*\*Preço do carregador. Bateria não incluída.

\* Apenas baterias cuja primeira letra de identificação seja "I" ou "J"

Baterias XGT, LXT, carregadores e compatibilidade de carregamento

						
DC18RC 195584-2	DC18RD 196933-6 2 portas	DC18RE 198720-9 2 portas CXT/LXT	DC18SF 196426-3 Multicarregador 4 portas * Exceto BL1430A.	DC18SH 199687-4 Carregador 2 portas	DC18SD 194533-6	DC18SE 194622-7 Automóvel
CARREGADOR RÁPIDO		CARREGADOR DUPLA RÁPIDO				
120€	220€	187€	315€	121€	81€	121€

**18V Litio-Ion**







Capacidade (Ah)	Modelo	Preço	Tempo de carga			
			55 min.	De 1 a 2 baterias 130 min.	De 2 a 4 baterias 260 min.	130 min.
6,0 Ah	 BL1860B 197422-4	248€	55 min.	130 min.	260 min.	130 min.
5,0 Ah	 BL1850B 197280-8	215€	45 min.	110 min.	220 min.	110 min.
4,0 Ah	 BL1840B 197265-4	182€	36 min.	90 min.	180 min.	90 min.
3,0 Ah	 BL1830B 197599-5	154€	22 min.	60 min.	120 min.	60 min.
2,0 Ah	 BL1820B 197254-9	121€	24 min.	45 min.	90 min.	45 min.
1,5 Ah	 BL1815N 196235-0	100€	15 min.	30 min.	60 min.	30 min.

**14,4V Litio-Ion**

Capacidade (Ah)	Modelo	Preço	Tempo de carga				
			36 min.	90 min.	De 1 a 2 baterias 90 min.	De 2 a 4 baterias 180 min.	90 min.
4,0 Ah	 BL1440 196388-5	177€	36 min.	90 min.	90 min.	180 min.	90 min.
3,0 Ah	 BL1430B 197615-3	149€	22 min.	60 min.	60 min.	120 min.	60 min.
1,5 Ah	 BL1415N 196875-4	118€	15 min.	30 min.	30 min.	60 min.	30 min.



Baterias XGT, LXT, carregadores e compatibilidade de carregamento

18V Litio-Ion		14,4V Litio-Ion		70/90 min.		80/105 min.			
1,5 Ah	 <b>77€</b> BL1815G 198186-3	2,0 Ah	 <b>80€</b> BL1820G 191N69-0	1,5 Ah	 <b>66€</b> BL1415G 198192-8	2,0 Ah	 <b>69€</b> BL1420G 191N76-3	 <b>57€</b> DC18WA 195423-6	 <b>35€</b> DC18WB 191W37-7
Para os modelos: DF457D, HP457D, JV183D, TD127D e DMR106.				Para os modelos: DF347D, HP347D, JV143D e DMR106.				*70min (1,5Ah) 90min (2,0Ah). *800min (1,5Ah) 105min (2,0Ah).	

CXT 12V		10,8V Litio-Ion		7,2V Litio-Ion	
4,0 Ah	 <b>97€</b> BL1041B 197406-2	 <b>120€</b> DC10SB 197363-4	 <b>82€</b> DC10WD 197343-0	 <b>50€</b> DC10WA 194588-1	 <b>56€</b> BL7015 198000-3
2,0 Ah	 <b>75€</b> BL1021B 197396-9	<b>60</b> min.	<b>130</b> min.	<b>50</b> min.	<b>1,5</b> Ah
	<b>30</b> min.	<b>70</b> min.	<b>1,3</b> Ah	<b>61€</b> BL1013 196066-7	

Adaptadores de corrente



 <b>Adaptador para DMR100 / DMR102 DMR107</b> SE0000078 <b>17,70€</b>	 <b>Adaptador para DMR106 / DMR108 DMR112</b> SE0000101 <b>26€</b>	 <b>Adaptador para DMR200 DMR201</b> SE00000501 <b>15,40€</b>	 <b>Adaptador para ADP07 DF001D</b> 198363-7 <b>13,50€</b>	 <b>Adaptador para DMR115</b> SE00000679 <b>33€</b>
 <b>Adaptador 12-24V para DCW180</b> WL00000002 <b>9,90€</b>	 <b>Adaptador 220V para DCW180</b> WL00000058 <b>82€</b>	 <b>Carregador DC4001 para PDC1200</b> 191L00-4 <b>196€</b>		

Baterias, carregadores e compatibilidade de carregamento



Lítio-ion **EXTREMA TECNOLOGIA**

**36V**

Carregador rápido



BL3626 194873-2 DC36RA 194863-5

P.V.P 290 € Tempo de carga **22** min P.V.P 193,50 €

**36V**

Carregador normal



BL3622A 195410-5 DC36WA 195471-5

P.V.P 250,50 € Tempo de carga **60** min P.V.P 100 €

**Ni - MH**

**24V**  
Ni-MH

DC24SC  
194164-1



**175,50€**

**3,1**  
Ah



**281,50€**

BH2433  
193739-3

**60**  
min.

**MAKSTAR**

**12V**  
Ni-MH

DC24SC  
194164-1



**175,50€**

DC18RC  
195584-2



**120€**



DC18SD  
194533-6

**81€**

DC18SE  
Automóvel 194622-7

**121€**

**3,1**  
Ah



**166€**

BH1233C  
193930-3

**30**  
min.

**22**  
min.

**70**  
min.

**9,6V**  
Ni-MH

DC24SC  
194164-1



**175,50€**

DC18RC  
195584-2



**120€**



DC18SD  
194533-6

**81€**

DC18SE  
Automóvel 194622-7

**121€**

**1,8**  
Ah



**141€**

BH9020  
193631-3

**20**  
min.

**15**  
min.

**40**  
min.

**Ni - MH**

**18V**

DC1804  
1941827-6

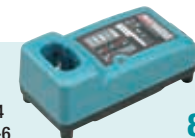

**80€**

DC1822  
Automóvel  
193439-5



**111,50€**

DC1414  
193864-0



**65,50€**

**2,8**  
Ah



**157,50€**

1835  
193061-8

**70**  
min.

**70**  
min.

**14,4V**

**2,8**  
Ah



**121€**

1435  
193060-0

**70**  
min.

**70**  
min.

**70**  
min.

**12V**

**2,8**  
Ah



**104€**

1235  
193059-5

**70**  
min.

**70**  
min.

**70**  
min.



# FONTES DE ALIMENTAÇÃO EXTERNAS

## PDC1200

### **Nova Bateria de mochila** 18Vx2 LXT / 40V máx

# 33,5Ah

Tem uma capacidade de 1200 Wh, 33,5 Ah e uma tensão entre 36 V e 40 V máx. (aproximadamente).

Até 2,8 vezes mais tempo de duração do que a nossa mochila porta-baterias PDC01 carregada com quatro baterias de 18 V LXT 6,0 Ah.

Compatível com: 18 V x 2 LXT (adaptador opcional), ligação de alimentação direta de 36 V e com 40 V máx. XGT (adaptador opcional).

Até seis vezes mais tempo de funcionamento com ferramentas de 18 V x 2 LXT e 6,0 Ah.



### IPX4



**Carregador: DC4001**

Tempo de carga: 6 horas



PDC1200A01 **1.984€\***  
PDC1200A02 **1.863€**  
\*Inclui adaptador 18Vx2

### Funções e vantagens

- Com bateria integrada de 40 V máx.
- Alta capacidade: 1200 Wh. (aprox. seis vezes mais tempo de funcionamento do que com ferramentas de 18 V x 2 LXT com BL1860B x 2)



#### Altura ajustável

A posição do arnês pode ser ajustada para maior conforto.



#### Arnês de remoção rápida

Pode ser encaixado e retirado da unidade de bateria com um só movimento.



#### Refletores

Para maior visibilidade do utilizador no escuro.

## Mochila porta-baterias

### PDC01

### IPX4



**191C50-5**  
Inclui adaptadores  
18V e 18Vx2  
4 baterias 5,0 Ah  
Multicarregador 2 portas  
**1.901€**

**191A59-5**  
Inclui adaptadores  
18V e 18Vx2  
**1.020€**

**191A64-2**  
Inclui adaptador  
18Vx2  
**728€**

### Funções e vantagens

- Com a possibilidade de ligar até 4 baterias LXT de 18V
- Alta capacidade: 432 Wh (com 4 baterias BL1860B)



#### Altura ajustável

A posição do arnês pode ser ajustada para maior conforto.



#### Arnês de mochila

Pode ser separado do compartimento das baterias, transformando-se assim numa fonte de alimentação fixa.



#### Indicador de carregamento

Indica o estado de carregamento de cada bateria com luzes verdes, com função de desligamento automático.



## Tipos de ligação e adaptadores

### Ligação direta



### 40V<sub>máx</sub>



**Adaptador 155€**  
191N62-4



### 18Vx2



**Adaptador 180€**  
191J51-5



### 18V (apenas PDC01)



**Adaptador 124€**  
191J50-7



## Especificações

	<b>PDC1200</b>	<b>PDC01</b>
Capacidade	33,5 Ah	*
Armazenamento	1.206 Wh	*
Número de células	100	-
Tempo de carga (horas)	6	-
Dimensões (C x L x A)	sem arnês: 369x261x139 mm com arnês: 428x261x164 mm	sem arnês: 400x195x132 mm com arnês: 400x270x149 mm
Peso líquido	sem arnês: 8,8 kg	sem baterias: 2,8 kg

\* Depende das baterias selecionadas.





**Kits de fontes de alimentação**

- Kits de baterias: 2 baterias de 8,0Ah, multicarregador rápido e mala Makpac3.



**191Y97-1 8,0 Ah**



2x BL4080F  
1x DC40RB  
1x 821551-8

**1.230€**

- Kits de baterias: 2 baterias de 5,0Ah, multicarregador rápido e mala Makpac3.



**191U13-9 5,0 Ah**



2x BL4050F  
1x DC40RB  
1x 821551-8

**859€**

- Kits de baterias: 2 baterias de 4,0Ah, multicarregador rápido e mala Makpac3.



**191U00-8 4,0 Ah**



2x BL4040  
1x DC40RB  
1x 821551-8

**761€**

- Kits de baterias: baterias de 4,0Ah e carregador rápido.



**191J65-4 4,0 Ah**



1x BL4040  
1x DC40RA

**413€**

- Kits de baterias: 2 baterias de 4,0Ah, carregador rápido e mala Makpac1.



**191J97-1 4,0 Ah**



2x BL4040  
1x DC40RA  
1x 821549-5

**744€**

- Kits de baterias: 2 baterias de 2,5Ah, carregador rápido e mala Makpac1.



**191J81-6 2,5 Ah**



2x BL4025  
1x DC40RA  
1x 821549-5

**540€**

- Kits de baterias: bateria de 2,5Ah e carregador rápido.



**191J39-5 2,5 Ah**



2x BL4025  
1x DC40RA

**513€**

- Kits de baterias: 2 baterias de 6,0Ah, multicarregador rápido e mala Makpac3.



**198077-8 6,0 Ah**



2x BL1860B  
1x DC18RD  
1x 821551-8

**717€**

- Kits de baterias: 2 baterias de 5,0Ah, multicarregador rápido e mala Makpac3.



**197626-8 5,0 Ah**



4x BL1850B  
1x DC18RD  
1x 821551-8

**882€**



**Kits de fontes de alimentação**

- Kits de baterias: 2 baterias de 6,0Ah, carregador rápido e mala Makpac1.

- Kits de baterias: 2 baterias de 6,0Ah e carregador rápido.

- Kits de bateria: bateria de 5,0Ah, carregador rápido e mala Makpac1.



**198116-4**

**6,0 Ah**



2x BL1860B  
1x DC18RC  
1x 821549-5

**661€**

**199480-6**

**6,0 Ah**



2x BL1860B  
1x DC18RC

**540€**

**198624-5**

**5,0 Ah**



1x BL1850B  
1x DC18RC  
1x 821549-5

**255€**

**Baterias, carregadores, kits fonte de alimentação e adaptadores**

Descrição	Código	EAN	P.V.P (€)
Bateria BL6440 64V - 4,0Ah	191R06-8	-	401,00
Bateria BL4080F 40V - 8,0Ah XGT	191X65-8	0088381589116	530,00
Bateria BL4050F 40V - 5,0Ah XGT	191L47-8	0088381580946	336,00
Bateria BL4040 40V - 4,0Ah XGT	191B26-6	0088381557498	287,00
Bateria BL4025 40V - 2,5Ah XGT	191B36-3	0088381556521	226,00
Bateria BL4020 40V - 2,0Ah XGT	191L29-0	0088381574549	204,00
Bateria BL1860B 18V - 6,0Ah LXT	197422-4	0088381464123	248,00
Bateria BL1850B 18V - 5,0Ah LXT	197280-8	0088381459129	215,00
Bateria BL1840B 18V - 4,0Ah LXT	197265-4	0088381459068	182,00
Bateria BL1830B 18V - 3,0Ah LXT	197599-5	0088381464055	154,00
Bateria BL1820B 18V - 2,0Ah LXT	197254-9	0088381459037	121,00
Bateria BL1815N 18V - 1,5Ah LXT	196235-0	0088381417556	100,00
Bateria BL1440 14,4V - 4,0Ah LXT	196388-5	0088381426671	177,00
Bateria BL1430B 14,4V - 3,0 Ah LXT	197615-3	0088381465083	149,00
Bateria BL1415N 14,4V - 1,5Ah LXT	196875-4	0088381443746	118,00
Bateria BL1815G 18V - 1,5Ah	198186-3	0088381475891	77,00
Bateria BL1820G 18V - 2,0Ah	191N69-0	0088381574884	80,00
Bateria BL1415G 14,4V - 1,5Ah	198192-8	0088381475952	66,00
Bateria BL1420G 14,4V - 2,0Ah	191N76-3	-	69,00
Bateria BL1041B 12V máx - 4,0Ah CXT	197406-2	0088381461658	97,00
Bateria BL1021B 12V máx - 2,0Ah CXT	197396-9	0088381459839	75,00
Bateria BL1013 10,8V 1,3Ah	196066-7	0088381405423	61,00
Bateria BL0715 7,2v litio	198000-3	0088381473392	56,00
DC40RB - Multicarregador 2 portas 40V Máx XGT	191N09-8	0088381579117	276,00
DC40RA - Carregador 40V Máx XGT	191E07-8	008838156354	171,00
DC40RC - Carregador 40V Máx XGT	191M90-3	0088381579261	100,00
DC18SF - Multicarregador 4 portas LXT	196426-3	0088381432979	315,00
DC18RD - Multicarregador rápido 2 portas LXT	196933-6	0088381444033	220,00
DC18SH - Multicarregador 2 portas LXT	199687-4	0088381542470	121,00
DC18RE - Multicarregador 2 portas 12V / 18V LXT	198720-9	0088381487924	187,00
DC18RC - Carregador rápido 18V LXT	195584-2	0088381373562	120,00
DC18SD - Carregador 18V LXT	194533-6	0088381345811	81,00
DC18SE - Carregador automóvel Litio	194622-7	0088381349673	121,00
DC18WA - Carregador BL1411/1811	195423-6	0088381371575	57,00

Descrição	Código	EAN	P.V.P (€)
DC18WB Carregador 7,2V - 18V	191W37-7	0088381588645	35,00
DC10SB Carregador 12V	197363-4	0088381459563	120,00
DC10WD Carregador 12V	197343-0	0088381459211	82,00
DC64WA Carregador 64V	191W19-9	-	166,00
DC10WA Carregador 10,8V	194588-1	0088381348065	50,00
DC4001 Carregador	191L00-4	0088381570688	196,00
PDC01 - Mochila porta-baterias com adaptador(x1) (x2)	191A59-5	0088381548588	1.020,00
PDC01- Mochila porta-baterias com adaptador (x2)	191A64-2	0088381548632	728,00
PDC01 - Mochila porta-baterias com 4 baterias BL1850B (5,0Ah) com adaptador(x1) (x2)	191C50-5	0088381553544	1.901,00
PDC1200A01 - Mochila porta-baterias	PDC1200A01	0088381728621	1.984,00
PDC1200A02 - Mochila porta-baterias	PDC1200A02	0088381728645	1.863,00
Kit fonte de alimentação 8,0Ah 2 Baterias BL4080F + DC40RB + Makpac3	191Y97-1	-	1.230,00
Kit fonte de alimentação 6,0Ah 2 Baterias BL1860B + DC18RC	198116-4	0088381474146	661,00
Kit fonte de alimentação 6,0Ah BL1860B + DC18RD	198077-8	0088381474511	717,00
Kit fonte de alimentação 5,0Ah 4 Baterias BL1850B + DC18RD + Makpac3	197626-8	0088381463164	882,00
Kit fonte de alimentação 40V máx 2,5Ah XGT 2 Baterias BL4025 + DC40RA	191J39-5	0088381561006	513,00
Kit fonte de alimentação 40V máx 4,0Ah XGT 2 Baterias BL4040 + DC40RA + Makpac1	191J97-1	0088381561389	744,00
Kit fonte de alimentação 40V máx 2,5Ah XGT 2 Baterias BL4025 + DC40RA + Makpac1	191J81-6	0088381561228	540,00
Kit fonte de alimentação 40V máx 4,0Ah XGT 2 Baterias BL4050F + DC40RB + Makpac3	191U13-9	0088381583039	859,00
Kit fonte de alimentação 40V máx 4,0Ah XGT 2 Baterias BL4040 + DC40RB + Makpac3	191U00-8	0088381582902	761,00
Kit fonte de alimentação 40V máx 4,0Ah XGT Bateria BL4040 + DC40RA	191J65-4	0088381561068	413,00
Kit fonte de alimentação 5,0Ah BL1850B + DC18RC + Makpac 1	198624-5	-	255,00
Kit fonte de alimentação 6,0Ah 2 Baterias BL1860B + DC18RC	199480-6	0088381537100	540,00
Adaptador ADP10 - 40V Máx / 18v XGT / LXT	191C10-7	0088381556422	71,00
Adaptador 383PCC0B11 - BMR100	SE00000078	0088381447829	17,70
Adaptador - BCF201ZW	TEB0000006	3240890380852	34,00
Adaptador - DMR106	SE00000101	0088381425162	26,00
Adaptador - DMR115	SE00000679	0088381588430	33,00
Adaptador 3A8A12C133B11 - DMR100	SE00000501	0088381534826	15,40
Adaptador ADP07 - DF001DW	198363-7	0088381525671	13,50
Adaptador 12-24V - DCW180	WL00000002	-	9,90
Adaptador 220V - DCW180	WL00000058	0088381591065	82,00

**Adaptadores**

• PDC01



191J50-7

• PDC01  
• PDC1200



191J51-5

• PDC01  
• PDC1200



191N62-4



Para	Descrição	Unds.	Código	EAN	P.V.P (€)
LXT	Adaptador simples LXT 18V	1	191J50-7	0088381560375	133,00
LXT	Adaptador duplo LXT 18Vx2	1	191J51-5	0088381560382	193,00
XGT	Adaptador simples XGT 40Vmax.	1	191N62-4	0088381580342	166,00

**Adaptador de bateria para cinto BAP36N e BAP182**

• Permite que a bateria seja separada da ferramenta, reduzindo assim o peso da máquina para uma menor fadiga do braço do utilizador.

36V

18V x 2



18V Novidade



\* Adaptador no válido para BC231UD e UX361D.

Modelo	Para	Descrição	Unds.	Código	EAN	P.V.P (€)
BAP36N *	36V	Permite que a(s) bateria(s) seja(m) separada(s) da ferramenta e assim conseguimos reduzir o seu peso.	1	195311-7	0088381363181	77,00
BAP182	18Vx2		1	197580-6	0088381463119	151,00
BAP18C **	18V		1	191M50-5	0088381571982	58,00

\*\* Adequado para aspiradores manuais.

**Conversor de bateria**

• Com duas baterias de 18 V (BL1860B, BL1850B, BL1840B, BL1830B) as máquinas de 36 V podem ser usadas.

BCV01 \*

18V x 2



BCV03

18V x 2



\* Adaptador não adequado para BC231UD e UX361D.

Modelo	Para	Descrição	Unds.	Código	EAN	P.V.P (€)
BCV01 *	36V	Adaptador 2 baterias de 18V a uma de 36V Mala + cabo + adaptador	1	195511-9	0088381371650	139,00
BCV03	36V	Adaptador 2 baterias de 18V a 36V. Adaptador direto na máquina	1	197214-1	0088381459013	123,00

### Adaptadores USB



DEBAP05

Para	Descrição	Unds.	Código	EAN	P.V.P (€)
LXT 18V	Adaptador para USB	1	DECADP05	-	32,00
CXT 12V	Adaptador para USB com gancho para cinto	1	DEAADP06	0088381825108	31,00
CXT 12V	Adaptador para USB	1	DEAADP08	0088381853224	31,00
XGT 40V	Adaptador para USB	1	DEAADP001G	-	54,00

### Adaptador para baterias Ni-Cd / Ni.Mh



Para	V	Unds.	Código	EAN	P.V.P (€)
Baterias Ni-Cd e Ni-MH	9,6 18V	1	193947-6	0088381188395	50,00

### Conectores de bateria para casacos



GM00001607



GM00001605



PE00000037



YL00000004

Modelos	Unds.	Código	EAN	P.V.P (€)	
Casacos ventilados	LXT 18V	1	198634-2	0088381486675	49,00
	CXT 12V	1	198639-2	0088381486729	48,00
Casacos aquecidos	LXT 18V	1	TD00000111	-	66,00
	CXT 12V	1	YL00000003	0088381537087	41,00

### Protetores translúcidos para chaves de impacto



Para	Unds.	Código	EAN	P.V.P (€)
DTW1001	1	413G40-5	0088381595070	33,00
TW001G	1	413G38-2	0088381595087	35,00
DTW700 DTW701 TW007G TW008G	1	413G39-0	0088381595063	27,00

### Protetores de bateria à prova de pó e água

- Concebido para proteger a bateria do pó e da água em condições adversas.



Para	Válido para	Unds.	Código	EAN	P.V.P (€)
14,4V BL1430B BL1440B	DTD148	1	195797-5	0088381376525	49,00
18V BL1830B BL1840B BL1850B	DHP458	1	195798-3	0088381376532	51,00

### Protetor de bateria

- Concebida para proteger a bateria contra choques acidentais e humidade.



Para	Unds.	Código	EAN	P.V.P (€)
BL1830 BL1840 BL1850 BL1860	1	459938-0	-	8,20
BL1415	1	454407-6	-	5,00
BL1815 BL1820B	1	459937-2	-	6,60

### Sistema AWS



Sistema AWS (Automatic Wireless System) que nos permite conectar o aspirador no modo autoconectado com as máquinas que possuem AWS, iniciando somente quando ligamos a máquina sem a necessidade de cabos.



Descrição	Unds.	Código	EAN	P.V.P (€)
Dispositivo AWS conexão por Bluetooth	1	198900-7	0088381497749	59,00

**Filtro para casacos ventilados**



Modelos	Unds.	Código	EAN	P.V.P (€)
DFJ301Z DFJ201Z	1	GM00001499	0088381471299	25,00

**Acessórios para pistola de silicone DCG180**

**A 196351-8**

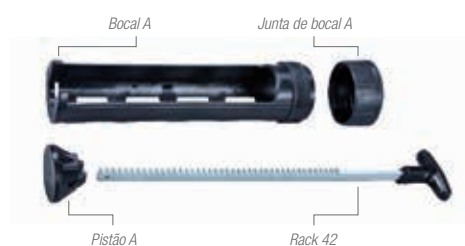

Desmontagem:

- Bocal A (tipo cartucho) 454275-7
- Junta de bocal A 454223-6
- Rack 42 142042-1
- Pistão A 142071-2

**B 191P89-6 / 1911T4-0**

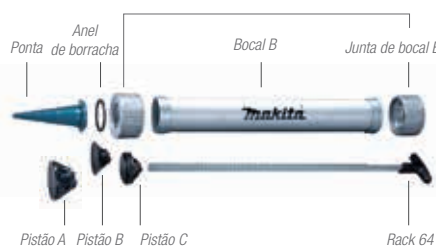

Desmontagem:

- Bocal B 141861-0
- Junta de bocal B 318958-2
- Anel de borracha 424547-4
- Ponta do bocal 454226-0
- Rack 64 142042-9
- Pistão A (tipo cartucho) 142071-2
- Pistão B (tipo salsicha) 142072-0
- Pistão C (vedante a granel) 123221-8

**C 197195-9**



Desmontagem:

- Bocal C 455951-6
- Junta do bocal C 455952-4
- Junta do bocal C (completa) 143223-8
- Pistão D (tipo cartucho) 143221-2
- Rack 53 143220-4



Capacidade	Tipo	Descrição	Unds.	Código	EAN	P.V.P (€)
300ml	A	Para colocar tubos de silicone de 300 ml	1	196351-8	0088381424271	46,00
400ml	B	Para colocar silicone em salsichas ou a granel	1	191P89-6	0088381580915	95,00
600ml	B		1	1911T4-0	0088381486729	134,00
800ml	C	Para colocar tubos de silicone de 800 ml	1	197195-9	0088381458221	76,00

**Bocal de silicone para tipos B e C**

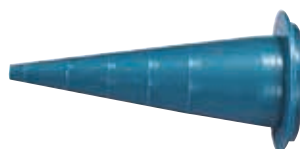

Tipo	Descrição	Unds.	Código	EAN	P.V.P (€)
B C	Bocal de silicone recortável	1	454226-0	0088381437080	4,10

**Acessórios para rebitoras DRV150/DRV250**



**Conjunto de mordentes para rebitoras**



Descrição	Unds.	Código	EAN	P.V.P (€)
Kit de mordentes para DRV150	1	199731-7	0088381568647	15,40
Kit de mordentes para DRV250	1	199730-9	0088381568630	15,40

**Bocais para rebites DRV150 / DRV250**



Descrição	Modelo	Unds.	Código	EAN	P.V.P (€)
2,4 mm	DRV150	1	199729-4	0088381567299	36,00
3,2 mm		1	199728-6	0088381567282	35,00
4,0 mm		1	191C04-2	0088381567275	17,70
4,8 mm		1	191C03-4	0088381567268	17,70
4,0 mm	DRV250	1	191F80-4	0088381567336	61,00
4,8 mm		1	191F79-9	0088381567329	29,00
6,0 mm		1	199725-2	0088381567312	29,00
6,4 mm		1	191F78-1	0088381567305	29,00

**Acessórios para pistola lubrificante DGP180**



Descrição	Unds.	Código	EAN	P.V.P (€)
Depósito tipo B 450g	1	191A81-2	0088381558440	98,00
Depósito tipo B 400g	1	191B12-7	0088381558433	97,00
Depósito tipo A 400g	1	191F24-4	0088381558464	77,00
Depósito tipo A 450g	1	191F25-2	0088381558471	74,00



Descrição	Unds.	Código	EAN	P.V.P (€)
Manguera flexível 1.200 mm	1	191W58-9	-	45,00
Manguera flexível 600 mm	1	191A80-4	0088381558518	66,00

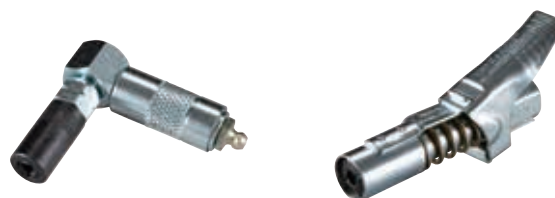

Descrição	Unds.	Código	EAN	P.V.P (€)
Adaptador de bocal angular	1	191A77-3	0088381567213	78,00
Adaptador de bocal com bloqueio	1	191A76-5	0088381567206	138,00



Descrição	Unds.	Código	EAN	P.V.P (€)
Kit de adaptadores (3 peças)	1	191A78-1	-	47,00



**Kits de arames para atadora de ferro DTR180/DTR181 e extensão de cabo**



**Extensão de cabo**

- Extensão de cabo para DTR180 indicado para reduzir o esforço e a fadiga nas costas. Inclui também um guia do antebraço acolchoado.



\* Ferramenta não incluída

Descrição	Unds.	Código	EAN	P.V.P (€)
Cabo extensor	1	191M27-0	0088381572675	198,00



Descrição	Unds.	Código	EAN	P.V.P (€)
Kit de arame 50 rolos	1	199137-9	0088381533928	201,00



Descrição	Unds.	Código	EAN	P.V.P (€)
Kit de arame galvanizado 50 rolos	1	191A57-9	0088381547949	287,00



- 50 rolos de arame de 100 metros cada.
- Diâmetro do fio de 0,8mm.

Descrição	Unds.	Código	EAN	P.V.P (€)
Kit de arame de poliéster 50 rolos	1	191J59-9	0088381560894	397,00

**Acessórios para bombas de ar MP100D-DMP180-DMP181-MP001**



TE00000333



TE00000334



TE00000335



TE00000597

Descrição	Unds.	Código	EAN	P.V.P (€)
Bocal para bomba de ar <0,5 bar	1	TE00000333	0088381547918	0,85
Bocal para bomba de ar 0,7 bar	1	TE00000334	0088381547925	0,55
Bocal para bomba de ar 0,9 bar	1	TE00000335	0088381547932	0,60
Adaptador britânico para bomba de ar	1	TE00000597	-	1,35

Acessórios para vibradores VR001/VR004

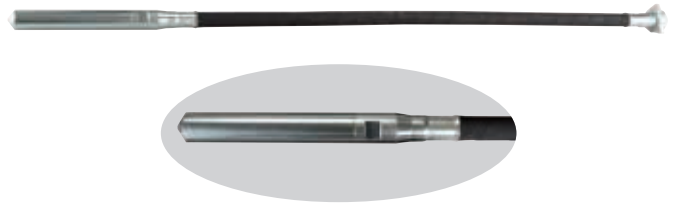

Descrição	Unds.	Código	EAN	P.V.P (€)
Kit eixo flexível 32 - 1,2M VR001	1	1910E1-5	0088381592222	300,00
Kit eixo flexível 32 - 1,7M VR004	1	1910E2-3	0088381592239	316,00
Kit eixo flexível 32 - 2,4M VR001	1	1910C2-9	0088381592246	326,00
Kit eixo flexível 38 - 2,4M VR004	1	1910C4-5	0088381592260	310,00



Descrição	Unds.	Código	EAN	P.V.P (€)
Protetor de bateria	1	1910J1-0	-	89,00



# ILUMINAÇÃO



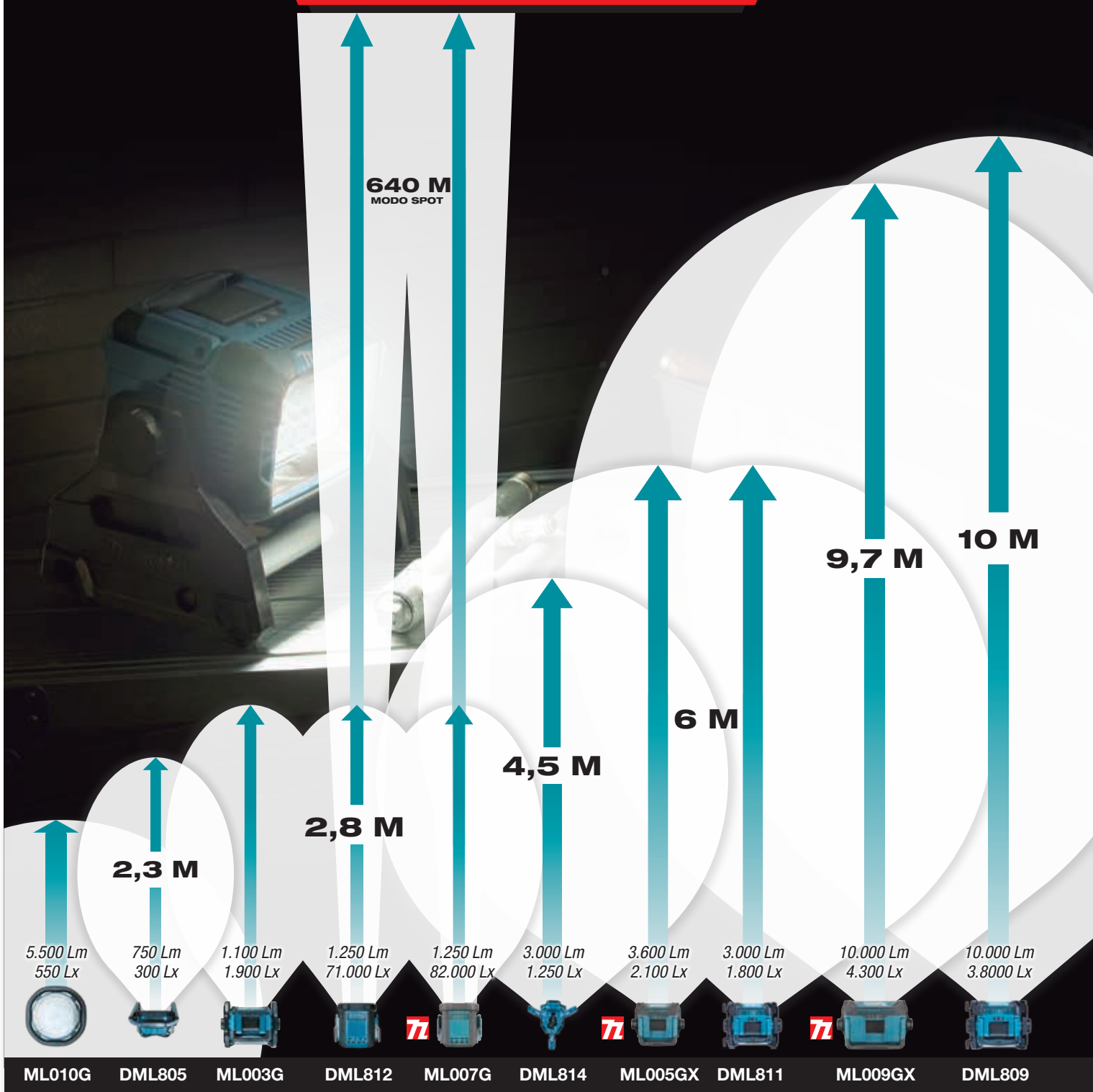





160 Lm  
3.000 Lx

160 Lm  
3.000 Lx

180 Lm  
4.000 Lx

180 Lm  
4.000 Lx

190 Lm  
4.500 Lx

190 Lm  
4.500 Lx

190 Lm  
5.500 Lx

130 Lm  
1.900 Lx

130 Lm  
1.900 Lx

90 Lm  
2.100 Lx

500 Lm  
800 Lx

500 Lm  
800 Lx

240 Lm  
400 Lx

- ML001G
- DEBDML815
- DEBDML802
- DEAML106
- DEBML106
- DEBDML808
- DEBML105
- ML002G
- DEAML104
- DEBDML806
- ML006GX
- DML816X
- DEBDML801



**Lanterna de área 5.500Lm - ML010**

- 3 ajustes de brilho: 5.500 / 3.000 / 1.500 Lm.
- 3 níveis de luminosidade: 550 / 280 / 130Lx. \*
- Bateria com tampa contra roubo.
- Capaz de ligar até 8 unidades ML010 em série.
- Acomoda duas baterias LXT.
- Certificado IP54 para resistência ao pó e à água. \*\*
- Tempo de Iluminação: 6,5H no modo 360 com BL4040x2.
- AC/DC.



\*A 1m de distância. \*\* Apenas com fonte de alimentação DC.

Dimensões	Unds.	Código	EAN	P.V.P (€)
490 x 490 x 814mm	1	ML010G	-	950,00

**Tripé ajustável 3.000 Lm - DML814**

- 3 ajustes de brilho: 3.000 / 1.700 / 900 Lm.
- 3 níveis de luminosidade: 1.250 / 750 / 400Lx. \*
- 3 cabeças rotativas individuais.
- Luz LED branca, ideal para o trabalho.
- Os fixadores têm um parafuso de ajuste.
- Tampa da bateria com cadeado.
- Tamanho compacto para fácil armazenamento e transporte.
- Tempo de Iluminação: 3H no modo alto com BL1850B.

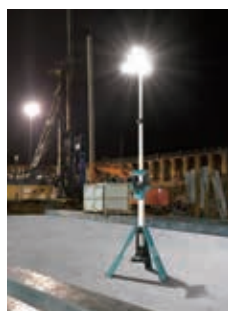

Dimensões	Unds.	Código	EAN	P.V.P (€)
573 x 658 x 2.240mm	1	DML814	0088381728614	452,00

**Novos focos de iluminação**



**Foco de iluminação 10.000Lm - ML009GX**

- 3 ajustes de brilho: 10.000 / 4.000 / 2.000 Lm.
- 3 níveis de luminosidade: 4.300 / 1.900 / 1.000 Lx. \*
- Função de memória na configuração de luminosidade.
- Classificação IP65 para resistência à água.
- Tempo de Iluminação: 2,4H no modo alto com BL4040x2.



Dimensões	Unds.	Código	EAN	P.V.P (€)
248 x 386 x 305 mm	1	ML009GX	-	555,00



Dimensões	Unds.	Código	EAN	P.V.P (€)
Tripé ML009GX	1	GM00002378	-	190,00

**Foco de iluminação 1.100Lm - ML005GX**

- 3 ajustes de brilho: 3.600 / 1.800 / 900 Lm.
- 3 níveis de luminosidade: 2.100 / 1.000 / 500 Lx.\*
- Função de memória na configuração de luminosidade.
- Classificação IP65 para resistência à água.
- Tempo de Iluminação: 3,5H no modo alto com BL4040.



Dimensões	Unds.	Código	EAN	P.V.P (€)
248 x 309 x 296 mm	1	ML005GX	-	330,00



Dimensões	Unds.	Código	EAN	P.V.P (€)
Difusor de luz DML811	1	GM00002358	-	12,50



Luzes LED de alta intensidade para maior alcance.  
Até 10 horas de iluminação contínua.  
Com uma potência de até 10 000 lúmenes.  
Compatível com baterias XGT e LXT

**Foco de iluminação 1.100Lm - ML003G**

- 2 ajustes de brilho: 1.100 / 450 Lm.
- 2 níveis de luminosidade: 500 / 200 Lx. \*
- Função de memória na configuração de luminosidade.
- Classificação IP65 para resistência à água.
- Tempo de Iluminação: 10H no modo alto com BL4040.



Dimensões	Unds.	Código	EAN	P.V.P (€)
249 x 298 x 280 mm	1	ML003GZ	0088381746632	231,00

**Foco de iluminação 10.000Lm - DEADML809**

- 3 ajustes de brilho: 10.000 / 4.000 / 2.000 Lm.
- 3 níveis de luminosidade: 3.800 / 1.500 / 800 Lx. \*
- Classificação IP65 para resistência à água.
- Tempo de Iluminação: 1,4H no modo alto com BL1850x2.



Dimensões	Unds.	Código	EAN	P.V.P (€)
249 x 370 x 370mm	1	DEADML809	0088381888264	474,00



Descrição	Unds.	Código	EAN	P.V.P (€)
Difusor de luz DML809	1	GM00002286	-	21,00
Tripé ajustável em altura 1,3 m a 2,0 m.		GM00002073	0088381548830	228,00

**Foco de iluminação 750Lm - DEADML805**

- 2 ajustes de brilho: 750 / 450 Lm.
- 2 níveis de luminosidade: 300 / 200 Lx. \*
- Muito leve. Punho de gancho.
- Tempo de Iluminação: 8,5H no modo alto com BL1850.



Dimensões	Unds.	Código	EAN	P.V.P (€)
214 x 261 x 328 mm	1	DEADML805	0088381699303	186,00



Descrição	Unds.	Código	EAN	P.V.P (€)
Fixação por gancho	1	GM00001396	0088381455688	22,00
Tripé	1	GM00002283	0088381579476	72,00
Difusor de luz DML805	1	GM00002377	-	19,00
Filme anti-ofuscante	1	GM00002376	-	12,00

**Foco de iluminação 3.000Lm - DML811**

- 3 ajustes de brilho: 3.000 / 1.500 / 750 Lm.
- 3 níveis de luminosidade: 1.800 / 800 / 350 Lx. \*
- Classificação IP65 para resistência à água.
- Tempo de Iluminação: 3H no modo alto com BL1860B.
- Ajuste do ângulo da luz: de -30° a 210°.



Dimensões	Unds.	Código	EAN	P.V.P (€)
249 x 302 x 271 mm	1	DML811	-	315,00



Descrição	Unds.	Código	EAN	P.V.P (€)
Difusor de luz DML811	1	GM00002287	-	14,30



**Foco de mão 1.250Lm - ML007G**

- 3 ajustes de brilho: 600Lm projetor, 1.000Lm lupa e 1.250Lm misto.
- 3 níveis de luminosidade: 82.000Lx projetor, 520Lx lupa e 60.000Lx misto. \*
- 4 modos: projetor, fixo, misto e estroboscópico.
- Distância de feixe até 640m no modo fixo.
- A cabeça da lanterna gira 90°.
- Tempo de iluminação: 10H no modo projetor com BL4040.



Dimensões	Unds.	Código	EAN	P.V.P (€)
330 x 120 x 133 mm	1	ML007G	0088381762342	182,00

**Foco de mão 1.250Lm - DML812**

- 3 ajustes de brilho: 600Lm projetor, 1.000Lm lupa e 1.250Lm misto.
- 3 níveis de luminosidade: 71.000Lx projetor, 500Lx lupa e 51.000Lx misto. \*
- 4 modos: projetor, fixo, misto e estroboscópico.
- Distância de feixe até 640m no modo fixo.
- A cabeça da lanterna gira 90°.
- Tempo de iluminação: 10H no modo projetor com BL1860B.



Dimensões	Unds.	Código	EAN	P.V.P (€)
313 x 119 x 115 mm	1	DML812	-	159,00

**Lanterna de mão - DEBDML186**

- 6 luzes LED. 1 nível de iluminação: 500Lx. \*
- Tempo de iluminação: 50H com BL1830B.



Dimensões	Unds.	Código	EAN	P.V.P (€)
151 x 81 x 61mm	1	DEBDML186	-	26,00



**Lanterna 190Lm - DEADML808**

- 1 ajuste de brilho: 190Lm.
- Nível de iluminação: de 170 – 4.500Lx. \*
- Cabeça pivotante com 12 posições de 0° a 170°.
- Com função zoom que ajusta o alcance da iluminação.
- Tempo de iluminação: 32H com BL1860B.



Dimensões	Unds.	Código	EAN	P.V.P (€)
297 x 79 x 119mm	1	DEBDML808	-	66,00

**Lanterna 190Lm - DEAML106**

- 1 ajuste de brilho: 190Lm.
- Nível de iluminação: 170-4.500Lx. \*
- Com função de zoom que ajusta o alcance da iluminação.
- Acessório magnético opcional.
- Reflector multifacético que ilumina uniformemente.
- Tempo de iluminação: 12H com BL1041B.



Dimensões	Unds.	Código	EAN	P.V.P (€)
290 x 66 x 93mm	1	DEAML106	0088381853125	66,00



### Lanterna 160Lm - ML001G

- 1 ajuste de brilho: 160Lm.
- 1 nível de iluminação: 3.000Lx. \*
- Cabeça pivotante com 12 posições de 0° a 170°.
- Tempo de iluminação: até 55H com BL4040.

**XST**  
**40V<sup>max</sup>**  
Li-ion



Dimensões	Unds.	Código	EAN	P.V.P (€)
287 x 88 x 136mm	1	ML001G	-	54,00

### Lanterna 180Lm - DEBDML802

- 1 ajuste de brilho: 180Lm.
- 1 nível de iluminação: 4.000Lx. \*
- Até 12 posições de cabeça.
- Tempo de iluminação: até 23H com BL1850B.

**18V**  
**LITHI-ION**



Dimensões	Unds.	Código	EAN	P.V.P (€)
272 x 79 x 116mm	1	DEBDML802	0088381675758	59,00

### Lanterna 160Lm - DEBDML815

- 1 ajuste de brilho: 160Lm.
- 1 nível de iluminação: 3.000Lx. \*
- Até 12 posições de cabeça.
- Tempo de iluminação: até 45H com BL1850B.

**18V**  
**LITHI-ION**



Dimensões	Unds.	Código	EAN	P.V.P (€)
272 x 79 x 116mm	1	DEBDML815	-	42,00

### Lanterna 190Lm - DEBML105

- 1 ajuste de brilho: 190Lm.
- 1 nível de iluminação: 5.500Lx. \*
- Até 12 posições de cabeça.
- Multi-reflector, que controla a direcção.
- Cabeça compacta feita de alumínio.
- Tempo de iluminação: 14H com BL1041B.

**12V<sup>max</sup>**  
**LITHI-ION**



Dimensões	Unds.	Código	EAN	P.V.P (€)
268 x 66 x 93mm	1	DEBML105	0088381836180	62,00



### Lanterna de tubo 710Lm - ML002G

- 3 ajustes de brilho: 710Lm "modo 360°", 340Lm modo 180° e 130Lm modo lanterna.
- 3 níveis de luminosidade: 340Lx modo 360°, 310Lx modo 180° e 1.900Lx modo lanterna. \*
- Interruptor com função de desligamento automático.
- Com porta USB integrada.
- Tempo de Iluminação: 16H de luz principal com BL4040B.  
(Sem uso de USB)



Dimensões	Unds.	Código	EAN	P.V.P (€)
431 x 86 x 175mm	1	ML002G	-	126,00

### Lanterna de tubo 710Lm - DEAML104

- 3 ajustes de brilho: 710Lm modo 360°, 190Lm modo 180° e 130Lm modo lanterna.
- 3 níveis de luminosidade: 340Lx modo 360°, 190Lx modo 180° e 1.900Lx modo lanterna. \*
- Porta USB integrada. Gancho retráctil para fixação.
- Acessório magnético opcional para operação mãos-livres.
- Tempo de iluminação: 17H de luz principal com BL1041B  
(Sem uso de USB)



Dimensões / Descrição	Unds.	Código	EAN	P.V.P (€)
414 x 66 x 132mm	1	DEAML104	0088381836173	109,00
Suporte magnético ML104	1	GM00001683	0088381479219	21,00

### Lanterna de tubo 620Lm - DEBDML806

- 3 ajustes de brilho: 620Lm modo 360°, 310Lm modo 180° e 90Lm modo lanterna.
- 3 níveis de luminosidade: 310Lx modo 360°, 280Lx modo 180° e 2.100Lx modo lanterna. \*
- 3 opções de uso: modo 360°, modo 180° e modo lanterna.
- Tempo de Iluminação: 21H de luz principal com BL1850B.



Dimensões	Unds.	Código	EAN	P.V.P (€)
365 x 78 x 119mm	1	DEBDML806	-	82,00



### Lanterna de farol 500Lm - ML006GX

- 3 ajustes de brilho: 500 / 250 / 100 Lm.
- 3 níveis de luminosidade: 800 / 400 / 180 Lx.\*
- Cabeça com 7 posições.
- Gancho retráctil para pendurar.
- Tempo de Iluminação: 20H em modo alto com BL4040.

XGT  
**40V**  
Li-ion  
max



Dimensões	Unds.	Código	EAN	P.V.P (€)
429 x 82 x 168 mm	1	ML006GX	-	90,00

### Lanterna de farol 500Lm- DML816X

- 3 ajustes de brilho: 500Lm / 250 / 100 Lm.
- 3 níveis de luminosidade: 800 / 400Lx / 180 Lx. \*
- Temperatura de cor de 5.000K.
- 7 posições da cabeça que gira para a esquerda e para a direita.
- Tempo de iluminação: 17H no modo alto com BL1860B.

**18V**  
LITHIUM-ION

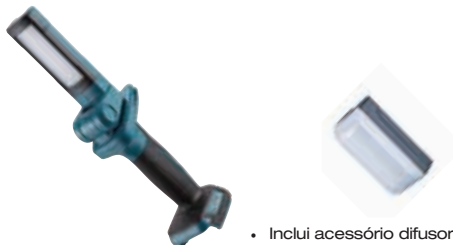

• Inclui acessório difusor GM00001326

Dimensões	Unds.	Código	EAN	P.V.P (€)
400 x 79 x 127mm	1	DML816X	-	82,00

### Lanterna de farol 240Lm - DEBDML801

- 2 ajustes de brilho: 240Lm / 120Lm.
- 2 níveis de luminosidade: 400 / 200Lx. \*
- Dobrável e com gancho giratório de 360°.
- 7 posições da cabeça que roda para a esquerda e para a direita.
- Tempo de iluminação: 9H no modo completo com BL1830B.

**18V**  
LITHIUM-ION



Dimensões	Unds.	Código	EAN	P.V.P (€)
380 x 79 x 116mm	1	DEBDML801	-	51,00

### Lanterna para cabeça 100Lm - DEBDML800

- 1 ajuste de brilho: 100Lm.
- 1 nível de iluminação: 2.000Lx. \*
- 7 posições giratórias.
- Classificação IP65 para resistência à água.
- Tempo de Iluminação: até 20H com BL1830B.

**18V**  
LITHIUM-ION



Dimensões	Unds.	Código	EAN	P.V.P (€)
151 x 76 x 88mm	1	DEBDML800	-	49,00

### Lanterna de mão 100Lm - ML103

- 1 ajuste de brilho: 100Lm,
- 1 nível de iluminação: 240Lx. \*
- Tempo de Iluminação: 28H com BL1041B.

**12Vmax**  
LITHIUM-ION



Dimensões	Unds.	Código	EAN	P.V.P (€)
87 x 64 x 73mm	1	DEBML103	0088381818636	30,00



**TABELA COMPARATIVA DE ILUMINAÇÃO**

	Modelo	XGT	LXT	CXT	DC IAC	Modos / iluminação	Modos / iluminância
	ML010G	✓	✓	-	✓	alto / médio / baixo 5.500 / 3.000 / 1.500Lm	alto / médio / baixo 550 / 300 / 150Lx a 1m de distância
	DML814	-	✓	-	-	alto / médio / baixo 3.000 / 1.700 / 900Lm	alto / médio / baixo 1250 / 750 / 400Lx a 1m de distância
	 ML009GX	✓	✓	-	-	alto / médio / baixo 10.000 / 4.000 / 2.000Lm	alto / médio / baixo 4.300 / 1.900 / 1.000Lx a 1m de distância
	 ML005G	✓	✓	-	-	alto / médio / baixo 3.600 / 1.800 / 900Lm	alto / médio / baixo 2.100 / 1.000 / 500Lx
	ML003G	✓	✓	-	-	alto / baixo 1.100 / 450Lm	alto / baixo 500 / 200Lx a 1m de distância
	DML809	-	✓	-	✓	alto / médio / baixo 10.000 / 4.000 / 2.000Lm	alto / médio / baixo 3.800 / 1.500L / 800Lx a 1m de distância
	DML805	-	✓	-	✓	alto / baixo 750 / 450Lm	alto / baixo 300 / 200Lx a 1m de distância
	DML811	-	✓	-	✓	alto / médio / baixo 3.000 / 1.500 / 750Lm	alto / médio / baixo 1.800 / 800 / 350Lx a 1m de distância
		DML812	-	✓	-	-	Projeter / Lupa / Misto 600 / 1.000 / 1.250Lm
 ML007G		✓	-	-	-	Projeter / Lupa / Misto / Estroboscópico 600 / 1.000 / 1250Lm	Projeter / Lupa / Misto / Estroboscópico 82.000 / 520 / 60.000Lx
	ML001G	✓	-	-	-	160Lm	3.000Lx a 1m de distância
	DML815	-	✓	-	-	160Lm	3.000Lx a 1m de distância
	ML105	-	-	✓	-	190Lm	5.500Lx a 1m de distância
	DML808	-	✓	-	-	190Lm	zoom 170 / 4.500Lx a 1m de distância
	DML802	-	✓	-	-	180Lm	4.000Lx a 1m de distância
	ML106	-	-	✓	-	190Lm	zoom 170 / 4.500Lx a 1m de distância
	ML002G	✓	-	-	-	360° / 180° / Lanterna 710 / 340 / 130Lm	360° / 180° / Lanterna 340 / 310 / 1.900Lx a 50cm de distância
	ML104	-	-	✓	-	Luz principal / secundária 710 / 130Lm	Luz principal / secundária 1.900 / 340Lx
	ML006GX	✓	-	-	-	alto / médio / baixo 500 / 250 / 100Lm	alto / médio / baixo 800 / 400 / 180Lx a 1 metro de distância
	DML816X	-	✓	-	-	alto / médio / baixo 500 / 250 / 100Lm	alto / médio / baixo 800 / 400 / 180Lx a 1 metro de distância
	DML806	-	✓	-	-	Luz principal / secundária 620 / 310Lm	Luz principal / secundária 310 / 280Lx
	DML801	-	✓	-	-	240Lm	Luz principal / secundária 400 / 200Lx a 0,5m de distância
	DML800	-	✓	-	-	100Lm	-
	ML103	-	-	✓	-	100Lm	-
	DML186	-	✓	-	-	6 LEDs	500Lx a 1 metro de distância



SDS - PLUS



SDS - MAX



Makita Hexagonal 17mm



Makita Hexagonal 19mm



Makita Hexagonal 21mm



Makita Hexagonal 28,6mm



Makita Hexagonal 30mm



B Hexagonal 19mm



K Hexagonal 21mm



# Perfuração e Percussão

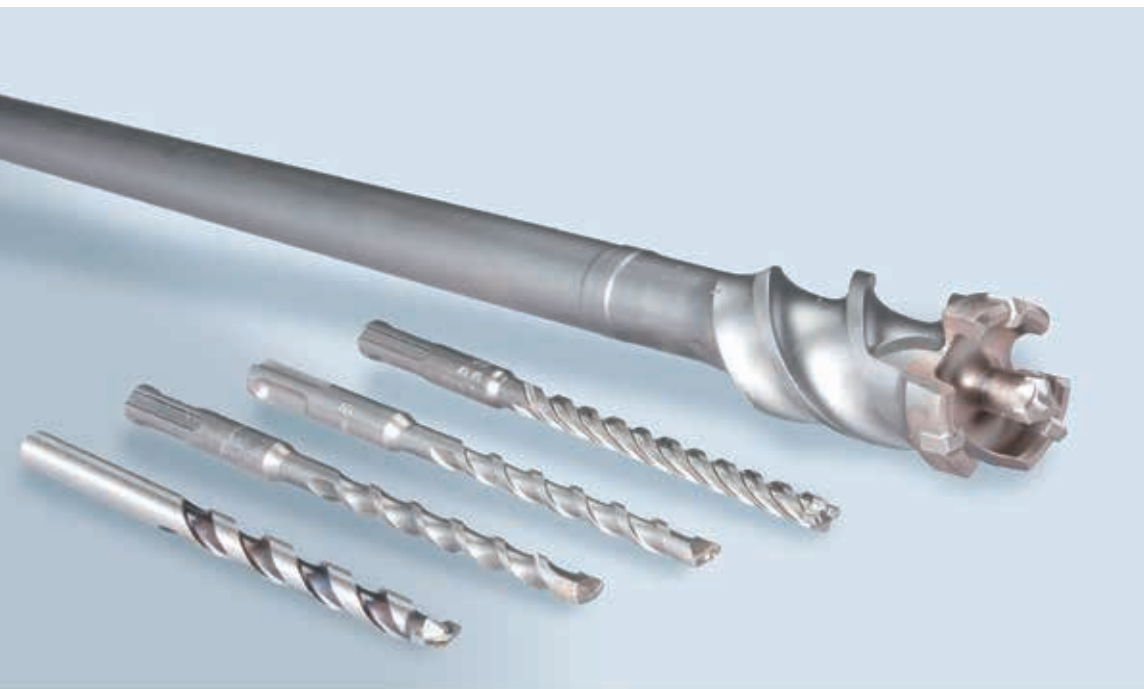

**MAK 4**



**MEMESSE**



Brocas SDS-PLUS **NEMESIS II**

**Resolve problemas**

Nota: quando encontramos hastes no betão armado, elas não precisam de ser apertadas. Deixar a broca cortar com uma leve pressão.

**A espiral**

O seu desenho em espiral de quatro saídas garante que a carga de perfuração é distribuída uniformemente ao longo do eixo da broca. O aço de alta qualidade e o tratamento especial da superfície garantem a resistência da broca.



4 x 90°, a broca corta uniformemente através do metal e não se bloqueia com as hastes de aço reforçado.



Núcleo da espiral melhorado. Garante baixas vibrações e excecional resistência à rutura.



A ponta centralizadora facilita a perfuração do material com uma precisão milimétrica.



O desenho simétrico das 4 espirais garante um desgaste baixo e uniforme.



A ampla geometria das espirais permite um transporte ideal do pó da perfuração.

**Brocas de 5 a 16mm.**



Ø (mm)	Comp. (mm)	Comp. útil (mm)	Unds.	Código	EAN	P.V.P. (€)
5	115	50	1	B-57897	0088381520782	5,30
5	165	100	1	B-57906	0088381520799	5,60
5	215	150	1	B-57912	0088381520805	8,60
5	265	200	1	B-57928	0088381520812	8,90
5,5	115	50	1	B-57940	0088381520836	5,30
5,5	165	100	1	B-57956	0088381520843	5,60
6	115	50	1	B-57962	0088381520850	5,30
6	165	100	1	B-57978	0088381520867	5,60
6	215	150	1	B-57984	0088381520874	7,20
6	265	200	1	B-57990	0088381520881	8,60
6	315	250	1	B-58001	0088381520898	11,90
6,5	165	100	1	B-58023	0088381520911	7,50
6,5	215	150	1	B-58039	0088381520928	9,70
6,5	265	200	1	B-58045	0088381520935	12,20
6,5	315	250	1	B-58051	0088381520942	14,80
7	115	50	1	B-58067	0088381520959	6,70
7	165	100	1	B-58073	0088381520966	7,50
7	215	150	1	B-58089	0088381520973	10,90
8	115	50	1	B-58095	0088381520980	6,10
8	165	100	1	B-58104	0088381520997	6,40
8	215	150	1	B-58110	0088381521000	7,50
8	265	200	1	B-58126	0088381521017	8,90
8	315	250	1	B-58132	0088381521024	12,20
8	465	400	1	B-58154	0088381521048	19,50
9	165	100	1	B-58176	0088381521062	7,00
10	115	50	1	B-58198	0088381521086	6,40
10	165	100	1	B-58207	0088381521093	7,20
10	215	150	1	B-58213	0088381521109	8,10
10	265	200	1	B-58229	0088381521116	9,50
10	315	250	1	B-58235	0088381521123	12,30
10	455	390	1	B-58257	0088381521147	21,00
10	600	540	1	B-58263	0088381521154	28,00
10	1000	940	1	B-58279	0088381521161	67,00
11	160	100	1	E-14495	0088381594097	8,20
11	210	160	1	E-14504	0088381594103	9,90
11	260	210	1	E-14510	0088381594110	11,60
11	310	260	1	E-14526	0088381594127	16,00
12	160	110	1	E-14532	0088381594134	7,70

**Brocas de 18 a 32mm.**



Ø (mm)	Comp. (mm)	Comp. útil (mm)	Unds.	Código	EAN	P.V.P. (€)
12	210	160	1	E-14548	0088381594141	9,40
12	260	210	1	E-14554	0088381594158	10,50
12	310	260	1	E-14560	0088381594165	14,90
12	450	400	1	E-14576	0088381594172	22,00
12	600	550	1	E-14582	0088381594189	28,00
12	1000	950	1	E-19598	0088381521277	67,00
14	160	110	1	E-14635	0088381594233	11,00
14	210	160	1	E-14641	0088381594240	14,90
14	260	210	1	E-14657	0088381594257	17,10
14	310	260	1	E-14663	0088381594264	18,20
14	450	400	1	E-14679	0088381594271	24,00
14	600	550	1	E-14685	0088381594288	31,00
14	1000	950	1	E-19607	0088381521383	70,00
15	160	110	1	E-14691	0088381594295	17,10
15	210	160	1	E-14700	0088381594301	19,30
15	260	210	1	E-14716	0088381594318	21,00
15	450	400	1	E-14722	0088381594325	28,00
16	160	110	1	E-14738	0088381594332	17,70
16	210	160	1	E-14744	0088381594349	20,00
16	260	210	1	E-14750	0088381594356	22,00
16	310	260	1	E-14766	0088381594363	25,00
16	450	400	1	E-14772	0088381594370	31,00
16	600	550	1	E-14788	0088381594387	39,00
16	1000	950	1	E-19613	0088381521499	80,00
18	250	200	1	B-58615	0088381521505	29,00
18	450	400	1	B-58621	0088381521512	33,00
20	250	200	1	B-58637	0088381521529	32,00
20	450	400	1	B-58659	0088381521543	39,00
22	250	200	1	B-58665	0088381521550	36,00
22	450	400	1	B-58687	0088381521574	48,00
24	250	200	1	B-58693	0088381521581	46,00
24	450	400	1	B-58702	0088381521598	52,00
25	250	200	1	B-58718	0088381521604	46,00
25	450	400	1	B-58724	0088381521611	58,00
28	250	200	1	B-58746	0088381521635	52,00
28	450	400	1	B-58752	0088381521642	67,00
30	250	200	1	B-58768	0088381521659	59,00
30	450	400	1	B-58774	0088381521666	74,00
32	450	400	1	B-58780	0088381521673	95,00

\* A partir de 18 mm, as brocas são de 3 peças de carboneto.

**Gama de brocas SDS-V-PLUS MAK4.**

**Para martelos SDS-PLUS. Brocas com cabeça de 4 pontas.**

**Pode perfurar em betão armado. Furos mais PRECISOS do que com brocas de 2 pontas.**

**Indicadas para todos os tipos de trabalho onde são utilizados martelos ligeiros SDS-PLUS.**



**Brocas de 5 a 25mm.**



Ø (mm)	Comp. (mm)	Comp. útil (mm)	Unds.	Código	EAN	P.V.P. (€)
5	110	50	1	B-68127	0088381544696	2,80
5	160	100	1	B-68133	0088381544702	2,80
6	110	50	1	B-62496	0088381529938	3,40
6	160	100	1	B-62505	0088381529945	3,40
6	210	150	1	B-62511	0088381529952	4,00
6	260	200	1	B-62527	0088381529969	4,30
8	110	50	1	B-62608	0088381530040	4,10
8	160	100	1	B-62614	0088381530057	4,10
8	210	150	1	B-62620	0088381530064	4,70
8	260	200	1	B-62636	0088381530071	5,20
8	310	250	1	B-62642	0088381530088	5,60
10	110	50	1	B-62664	0088381530101	5,50
10	160	100	1	B-62670	0088381530118	5,50
10	210	150	1	B-62686	0088381530125	6,00
10	260	200	1	B-62692	0088381530132	6,60
10	310	250	1	B-62701	0088381530149	6,90
12	160	100	1	B-62739	0088381530170	7,40
12	210	150	1	B-62745	0088381530187	8,00
12	260	200	1	B-62751	0088381530194	8,60
12	310	250	1	B-62767	0088381530200	8,80
12	350	290	1	B-62773	0088381530217	9,90
14	160	100	1	B-62795	0088381530231	11,00
14	210	150	1	B-62804	0088381530248	11,60
14	260	200	1	B-62810	0088381530255	12,10
14	310	250	1	B-62826	0088381530262	12,40
14	350	290	1	B-62832	0088381530279	12,70
16	160	100	1	B-62854	0088381530293	13,20
16	210	150	1	B-62860	0088381530309	13,80
16	260	200	1	B-62876	0088381530316	14,40
16	310	250	1	B-62882	0088381530323	15,70
16	350	290	1	B-62898	0088381530330	16,30
18	260	200	1	B-68177	0088381544740	21,00
18	460	400	1	B-68236	0088381544801	26,00
20	260	200	1	B-68183	0088381544757	27,00
20	460	400	1	B-68242	0088381544818	31,00
22	260	200	1	B-68199	0088381544764	33,00
22	460	400	1	B-68258	0088381544825	41,00
25	260	200	1	B-68208	0088381544771	42,00
25	460	400	1	B-68264	0088381544832	45,00



• **Potência de rutura.**

Efeito de demolição.  
Produz microrroturas na perfuração.  
Gera maior velocidade de perfuração

• **Reduz o atrito nas laterais para aumentar a velocidade.**

• **Duração em betão armado.**

Maior duração (+35 %).  
Evita danos na pastilha quando atinge a haste.  
Reduz a probabilidade de engate durante a perfuração.

• **Flauta KVS.**

Geometria cônica da flauta.  
Assim, oferece alta velocidade e resistência à rutura.

• **Pastilha centralizadora.**

• **Alta durabilidade.**

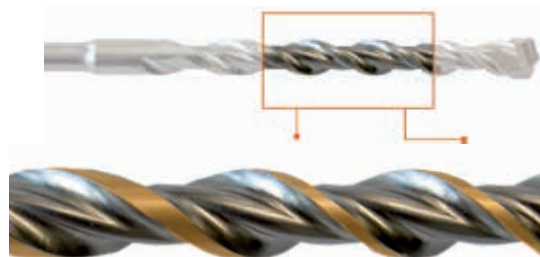

Ø (mm)	Comp. (mm)	Comp. útil (mm)	Unds.	Código	EAN	P.V.P. (€)
3,5	110	50	1	E-10665	0088381580434	6,10
4	110	50	1	B-47232	0088381454315	3,40
4	160	100	1	B-47248	0088381454322	3,90
4,5	160	100	1	E-10671	0088381580441	6,10
5	110	50	1	B-46492	0088381452427	2,80
5	160	100	1	B-46501	0088381452434	3,05
5,5	110	50	1	B-47298	0088381454377	2,80
5,5	160	100	1	B-47307	0088381454384	3,60
5,5	210	150	1	B-47313	0088381454391	6,40
6	110	50	1	B-46517	0088381452441	2,80
6	160	100	1	B-46523	0088381452458	2,80
6	210	150	1	B-47341	0088381454421	4,20
6	260	200	1	B-47357	0088381454438	5,30
6,5	110	50	1	B-47385	0088381454469	3,05
6,5	160	100	1	B-47391	0088381454476	3,60
6,5	210	150	1	B-47400	0088381454483	4,70
6,5	260	200	1	B-47416	0088381454490	6,40
7	110	50	1	B-47438	0088381454513	3,05
7	160	100	1	B-47444	0088381454520	3,40
7	210	150	1	B-47450	0088381454537	5,00
8	110	50	1	B-46539	0088381452465	3,05
8	160	100	1	B-46545	0088381452472	3,40
8	210	150	1	B-47472	0088381454551	4,40
8	260	200	1	B-47488	0088381454568	5,60
8	400	340	1	B-47503	0088381454582	10,50
8	600	540	1	B-47525	0088381454605	15,60
9	160	100	1	B-47531	0088381454612	4,20
9	210	150	1	B-47547	0088381454629	5,60
9,5	160	100	1	B-47553	0088381454636	4,70
10	110	50	1	B-46551	0088381452489	3,60
10	160	100	1	B-46567	0088381452496	3,90
10	210	150	1	B-47569	0088381454643	5,20
10	260	200	1	B-47575	0088381454650	6,10
10	310	250	1	B-47581	0088381454667	7,00
10	450	390	1	B-47606	0088381454681	11,70

Ø (mm)	Comp. (mm)	Comp. útil (mm)	Unds.	Código	EAN	P.V.P. (€)
10	600	540	1	B-47612	0088381454698	16,10
10	1000	940	1	B-47634	0088381454711	41,00
11	160	110	1	B-47640	0088381454728	5,80
11	210	160	1	B-47656	0088381454735	6,40
11	260	210	1	B-47662	0088381454742	7,80
12	160	110	1	B-46573	0088381452502	4,70
12	210	160	1	B-47684	0088381454766	5,80
12	260	210	1	B-47690	0088381454773	7,20
12	310	260	1	B-47709	0088381454780	9,20
12	450	400	1	B-47721	0088381454803	12,80
12	600	550	1	B-47737	0088381454810	16,70
12	1000	950	1	B-47759	0088381454834	44,00
13	160	110	1	B-47765	0088381454841	5,80
13	210	160	1	B-47771	0088381454858	6,70
13	260	210	1	B-47787	0088381454865	7,80
13	310	260	1	B-47793	0088381454872	10,00
14	160	110	1	B-46589	0088381452519	6,40
14	210	160	1	B-47802	0088381454889	7,20
14	260	210	1	B-47818	0088381454896	8,90
14	310	260	1	B-47824	0088381454902	10,00
14	450	400	1	B-47830	0088381454919	15,60
14	600	550	1	B-47846	0088381454926	18,40
14	1000	950	1	B-47852	0088381454933	45,00
15	160	110	1	B-47868	0088381454940	8,10
15	210	160	1	B-47874	0088381454957	9,40
15	260	210	1	B-47880	0088381454964	10,30
15	450	400	1	B-47896	0088381454971	16,20
16	160	110	1	B-47905	0088381454988	7,80
16	210	160	1	B-47911	0088381454995	9,50
16	310	260	1	B-47933	0088381455015	12,30
16	450	400	1	B-47949	0088381455022	18,40
16	600	550	1	B-47955	0088381455039	22,00
16	800	750	1	B-47961	0088381455046	33,00
16	1000	950	1	B-47977	0088381455053	51,00
17	210	160	1	B-47983	0088381455060	14,40

**Brocas StandMak para martelos SDS-PLUS**



Ø (mm)	Comp. (mm)	Comp. útil (mm)	Unds.	Código	EAN	P.V.P. (€)
3,5	110	50	1	D-15665	0088381170079	1,25
4	110	50	1	D-00016	0088381169004	1,30
5	110	50	1	D-00022	0088381169011	1,30
5	160	100	1	D-00038	0088381169028	1,30
5,5	110	50	1	D-00044	0088381169035	1,30
5,5	160	100	1	D-16106	0088381187381	1,30
6	110	50	1	D-00050	0088381169042	1,30
6	160	100	1	D-00066	0088381169059	1,30
6	210	150	1	D-00072	0088381169066	1,60
6,5	110	50	1	D-00088	0088381169073	1,30
6,5	160	100	1	D-00094	0088381169080	1,30
7	110	50	1	D-00103	0088381169097	1,30
7	160	100	1	D-00119	0088381169103	1,30
8	110	50	1	D-00125	0088381169110	1,30
8	160	100	1	D-00131	0088381169127	1,30
8	210	150	1	D-00147	0088381169134	1,60
8	260	200	1	D-00153	0088381169141	2,00
9	160	100	1	D-08056	0088381182379	1,60
9	210	150	1	D-00169	0088381169158	1,60
9,5	210	150	1	D-03274	0088381173520	1,60
10	160	100	1	D-00175	0088381169165	1,60
10	210	150	1	D-00181	0088381169172	1,95
10	260	200	1	D-00197	0088381169189	1,95
10	310	250	1	D-00206	0088381169196	2,55
10	460	400	1	D-17538	0088381196574	4,50
12	160	100	1	D-00228	0088381169219	1,60
12	210	150	1	D-00234	0088381169226	1,95
12	260	200	1	D-00240	0088381169233	1,95
12	460	400	1	D-16271	0088381187558	4,90
13	160	100	1	D-00256	0088381169240	1,85
13	350	290	1	D-16128	0088381187404	2,95
14	160	100	1	D-00262	0088381169257	2,00
14	260	200	1	D-00278	0088381169264	2,60
14	460	400	1	D-17544	0088381196581	5,20
16	210	150	1	D-00290	0088381169288	3,70
16	310	250	1	D-00309	0088381169295	4,50
16	460	400	1	D-16287	0088381187565	6,20
18	210	150	1	D-00321	0088381169318	3,60
18	300	240	1	D-00337	0088381169325	4,60
18	460	400	1	D-17566	0088381196604	7,20
20	210	150	1	D-00359	0088381169349	4,50
20	310	250	1	D-00365	0088381169356	7,40
20	460	400	1	D-15235	0088381186339	7,70
22	260	200	1	D-00371	0088381169363	5,90

Ø (mm)	Comp. (mm)	Comp. útil (mm)	Unds.	Código	EAN	P.V.P. (€)
22	310	250	1	D-08062	0088381182386	7,10
22	460	400	1	D-15241	0088381186346	8,50
24	460	400	1	D-16302	0088381187589	9,70
25	260	200	1	D-00387	0088381169370	7,70
25	310	250	1	D-08517	0088381182454	9,10
25	460	400	1	D-15257	0088381186353	11,10
26	260	200	1	D-00393	0088381169387	10,50
26	460	400	1	D-15263	0088381186360	12,40
28	460	400	1	D-16318	0088381187596	17,60
30	460	400	1	D-17572	0088381196611	21,00

**Brocas StandMak para martelos SDS-PLUS**

• **Caixas de 25 unidades.**



\* Fornecidas em caixa de cartão. Brocas soltas.

Ø (mm)	Comp. (mm)	Comp. útil (mm)	Unds.	Código	EAN	P.V.P. (€)
5	110	50	25	D-01155-25	0088381170598	23,00
6	110	50	25	D-01161-25	0088381170604	25,00
6	160	100	25	D-01177-25	0088381170611	30,00
8	160	100	25	D-01183-25	0088381170628	30,00
8	210	150	25	D-01199-25	0088381170635	37,00
10	160	100	25	D-01208-25	0088381170642	30,00
10	210	150	25	D-03707-25	0088381173995	41,00
12	160	100	25	D-03713-25	0088381174008	36,00
12	210	150	25	D-03729-25	0088381174015	41,00

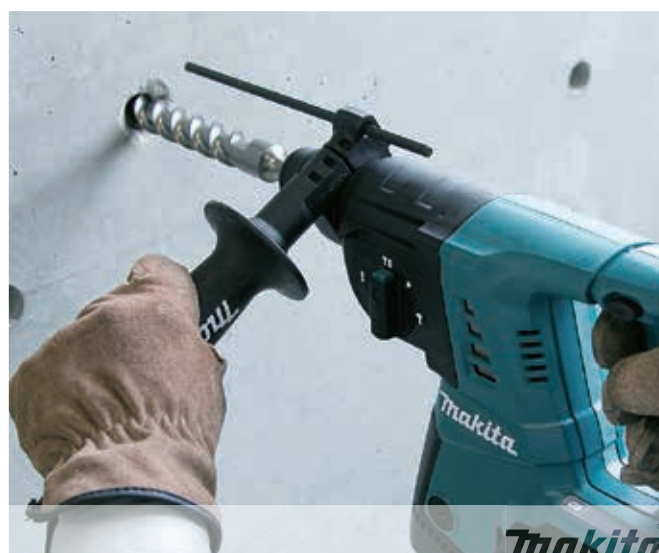

**Kits de brocas e estojos**

**SDS-PLUS Némesis (7 peças)**



**NEMESIS II**



Ø (mm)	Comp. (mm)	Comp. útil (mm)	Unds.	Código	EAN	P.V.P. (€)
5	110	50	1	E-14928	0088381594523	51,00
6	110	50	1			
8	110	50	1			
6	160	100	1			
8	160	100	1			
10	160	100	1			
12	160	100	1			



**SDS-PLUS Némesis (3 peças)**



**NEMESIS II**



Ø (mm)	Comp. (mm)	Comp. útil (mm)	Unds.	Código	EAN	P.V.P. (€)
6	160	100	1	B-59075	0088381521963	21,00
8	160	100	1			
10	160	100	1			

**SDS-V-PLUS (13 peças)**



**MAK 4**



Ø (mm)	Comp. (mm)	Comp. útil (mm)	Unds.	Código	EAN	P.V.P. (€)
6	110	50	1	B-64674	0088381535762	94,00
6	160	100	1			
7	110	50	1			
7	160	100	1			
8	110	50	1			
8	160	100	1			
10	110	50	1			
10	160	100	1			
12	160	100	1			
14	160	100	1			
16	160	100	1			
Ponteiro 250 mm			1			
Cinzel 20 x 250 mm			1			

**SDS-V-PLUS (5 peças)**



**MAK 2**



Ø (mm)	Comp. (mm)	Comp. útil (mm)	Unds.	Código	EAN	P.V.P. (€)
5	110	50	1	B-49052	0088381457460	15,60
6	110	50	1			
8	110	50	1			
6	160	100	1			
8	160	100	1			

**V-PLUS (7 peças)**



**MAK 2**



Ø (mm)	Comp. (mm)	Comp. útil (mm)	Unds.	Código	EAN	P.V.P. (€)
5	110	50	1	B-49046	0088381457453	31,00
6	110	50	1			
8	110	50	1			
6	160	100	1			
8	160	100	1			
10	160	100	1			
12	160	100	1			

**SDS-PLUS StandMak**



Ø (mm)	Comp. (mm)	Comp. útil (mm)	Unds.	Código	EAN	P.V.P. (€)
6,5	160	100	1	D-74728	0088381589291	8,80
8	160	100	1			
10	160	100	1			
12	160	100	1			
5	110	50	1	D-74136	0088381587174	8,80
6	160	100	1			
8	160	100	1			
10	160	100	1			

**Estojo de brocas para betão / tijolo**



Ø (mm)	Comp. (mm)	Unds.	Código	EAN	P.V.P. (€)
6-8-10-12	160	1	D-74756	0088381590181	9,40

**Kit brocas para berbequins SDS-PLUS 4pçs**



**Estojo de brocas SDS-PLUS**



Ø (mm)	Comp. (mm)	Unds.	Código	EAN	P.V.P. (€)
6,8(x2) e 10(x2)	110/160	1	B-54704	0088381478427	12,50

**Expositor de cartão com 12 caixas de 4 peças cada.**

Ø (mm)	Comp. (mm)	Comp. útil (mm)	Unds.	Código	EAN	P.V.P. (€)
5	110	100	1	E-13596-12	0088381592055	149,00
6	160	100	1			
8	160	100	1			
10	160	100	1			



**Estojo StandMak para martelos SDS-PLUS 5 pçs**



Ø (mm)	Comp. (mm)	Comp. útil (mm)	Unds.	Código	EAN	P.V.P. (€)
5	110	50	1	D-00795	0088381171182	5,80
6	110	50	1			
8	110	50	1			
6	160	100	1			
8	160	100	1			

**Conjunto de demolição e brocas Standmak**



Ø (mm)	Comp. (mm)	Comp. útil (mm)	Unds.	Código	EAN	P.V.P. (€)
5	110	50	1	D-19180	0088381253826	60,00
6	110	50	1			
8	110	50	1			
10	110	100	1			
6	160	100	1			
8	160	100	1			
10	160	100	1			
12	160	100	1			
8	210	140	1			
10	210	140	1			
12	260	175	1			
14	260	175	1			
Ponteiro 14 x 140mm			1			
Ponteiro 14 x 250mm			1			
Cinzel 20 x 140mm			1			
Cinzel 20 x 250mm			1			
Espátula 40 x 250mm			1			

**Brocas de coroa para martelos SDS-PLUS**



Ø (mm)	Comp. (mm)	Unds.	Código	EAN	P.V.P. (€)
40	60	1	P-26191	0088381953092	44,00
50	60	1	P-26200	0088381953108	58,00
65	60	1	P-26216	0088381953115	59,00
80	60	1	P-26222	0088381953122	65,00

**Broca centradora**

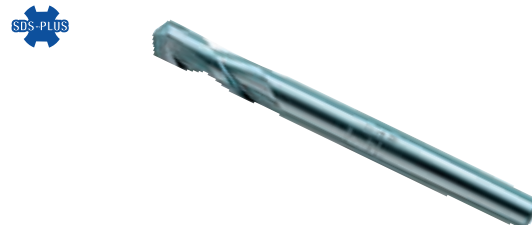

Ø (mm)	Comp. (mm)	Ponta	Unds.	Código	EAN	P.V.P. (€)
8	120	TCT	1	P-64347	0088381994866	6,70

**Adaptador**



Rosca (mm)	Comp. (mm)	Unds.	Código	EAN	P.V.P. (€)
M16	105	1	P-67745	0088381998277	22,00
M16	370	1	P-67751	0088381998284	34,00





**Brocas de coroa para alvenaria**



Ø (mm)	Comp. (mm)	Unds.	Código	EAN	P.V.P. (€)
30	50	1	D-73891	0088381586801	7,70
35	50	1	D-73900	0088381586818	8,20
40	50	1	D-73916	0088381586825	8,60
50	50	1	D-73922	0088381586832	10,00
68	50	1	D-73938	0088381586849	12,90
82	50	1	D-73944	0088381586856	17,70
90	50	1	D-73950	0088381586863	21,00
100	50	1	D-73966	0088381586870	24,00

**Broca centradora**



Ø (mm)	Comp. (mm)	Unds.	Código	EAN	P.V.P. (€)
8	110	1	D-73972	0088381586887	1,75

**Conjunto de broca + adaptador**



Ø (mm)	Comp. (mm)	Unds.	Código	EAN	P.V.P. (€)
68	175	1	D-74011	0088381586924	18,70
82	175	1	D-74027	0088381586931	24,00

**Adaptadores**



Ø (mm)	Comp. (mm)	Unds.	Código	EAN	P.V.P. (€)
110	110	1	D-73988	0088381586894	4,20
200	200	1	D-73994	0088381586900	6,30
350	350	1	D-74005	0088381586917	8,80





**Brocas para martelos SDS-MAX**

**Mais precisão, menos vibração, mais potência de perfuração.**

- Três peças de carboneto com uma geometria de corte única.

Ângulo da pastilha modificado



Pastilha biselada em pontos diferentes

**MAK 4**

- A geometria renovada da broca de 4 x 90° evita o engate da pastilha de carboneto no betão armado. Pastilhas laterais muito robustas com forma de corte curva que apoiam a pastilha central nos cortes rápidos.
- Ponto de centragem de 130° para facilitar o início da perfuração e garantir uma orientação perfeita.
- Cada pastilha lateral é marcada com uma linha que indica o desgaste, para podermos avaliar a precisão dos furos de ancoragem.
- Pastilhas de carboneto perfeitamente soldadas ao corpo de aço da broca.
- Ponta de carboneto de grandes dimensões com tecnologia patenteada de chanfragem lateral\* para uma perfuração eficaz em betão armado.

\* A partir de ø32mm.

- O desenho da cabeça da broca confere-lhe uma elevada dureza, o que facilita um efeito de demolição agressivo e uma elevada velocidade de perfuração.
- Desenho patenteado da espiral com excelente desempenho entre a extração de pó e a resistência à rutura.

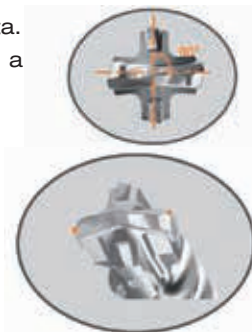

Ø (mm)	Comp. (mm)	Comp. útil (mm)	Unds.	Código	EAN	P.V.P. (€)
16	340	200	1	P-77730	0088381708487	39,00
16	540	400	1	P-77746	0088381708494	46,00
16	1320	1180	1	P-77768	0088381708517	162,00
18	340	200	1	P-77774	0088381708524	44,00
18	540	400	1	P-77780	0088381708531	48,00
18	1320	1180	1	P-77805	0088381708555	165,00
20	320	200	1	P-77811	0088381708562	44,00
20	520	400	1	P-77827	0088381708579	50,00
20	920	800	1	P-77833	0088381708586	73,00
22	320	200	1	P-77855	0088381708609	49,00
22	520	400	1	P-77861	0088381708616	54,00
22	920	800	1	P-77877	0088381708623	77,00
22	1320	1200	1	P-77883	0088381708630	179,00
24	320	200	1	P-77899	0088381708647	52,00
24	520	400	1	P-77908	0088381708654	60,00
25	320	200	1	P-77914	0088381708661	51,00
25	520	400	1	P-77920	0088381708678	60,00
25	920	800	1	P-77936	0088381708685	90,00
26	520	400	1	P-77958	0088381708708	65,00
28	370	250	1	P-77964	0088381708715	57,00

Ø (mm)	Comp. (mm)	Comp. útil (mm)	Unds.	Código	EAN	P.V.P. (€)
28	570	450	1	P-77970	0088381708722	68,00
28	670	550	1	P-77986	0088381708739	88,00
28	920	800	1	P-77992	0088381708746	105,00
28	1320	1200	1	P-78003	0088381708753	196,00
30	370	250	1	P-78019	0088381708760	63,00
30	570	450	1	P-78025	0088381708777	74,00
32*	370	250	1	P-78031	0088381708784	65,00
32*	570	450	1	P-78047	0088381708791	79,00
32*	920	800	1	P-78053	0088381708807	120,00
35	370	250	1	P-78075	0088381708821	78,00
35	570	450	1	P-78081	0088381708838	90,00
35	670	550	1	P-78097	0088381708845	109,00
38	370	250	1	P-78134	0088381708883	94,00
38	570	450	1	P-78140	0088381708890	111,00
40	370	250	1	P-78156	0088381708906	111,00
40	570	450	1	P-78162	0088381708913	134,00
40	920	800	1	P-78178	0088381708920	179,00
40	1320	1200	1	P-78184	0088381708937	244,00
45	570	450	1	P-78190	0088381708944	189,00
50	570	450	1	P-78215	0088381708968	215,00

**Brocas para martelos SDS-MAX**

**TCT - 4 cortes**



Ø (mm)	Comp. (mm)	Comp. útil (mm)	Unds.	Código	EAN	P.V.P. (€)
12	340	200	1	E-11324	0088381582605	12,50
12	540	400	1	E-11330	0088381582612	17,20
14	340	200	1	E-11346	0088381582629	15,50
14	540	400	1	E-11352	0088381582636	20,00
16	340	200	1	E-11368	0088381582643	18,40
16	540	400	1	E-11374	0088381582650	23,00
18	340	200	1	E-11380	0088381582667	25,00
18	540	400	1	E-11396	0088381582674	29,00

Ø (mm)	Comp. (mm)	Comp. útil (mm)	Unds.	Código	EAN	P.V.P. (€)
20	340	220	1	E-11405	0088381582681	29,00
20	540	420	1	E-11411	0088381582698	35,00
22	340	220	1	E-11427	0088381582704	34,00
22	540	420	1	E-11433	0088381582711	40,00
24	340	220	1	E-11449	0088381582728	39,00
24	540	420	1	E-11455	0088381582735	45,00
25	340	220	1	E-11461	0088381582742	40,00
25	540	420	1	E-11477	0088381582759	46,00
28	370	250	1	E-11483	0088381582766	50,00
28	570	450	1	E-11499	0088381582773	61,00
30	370	250	1	E-11508	0088381582780	61,00
30	570	450	1	E-11514	0088381582797	75,00

**Brocas SDS-MAX PADRÃO**



Ø (mm)	Comp. (mm)	Comp. útil (mm)	Unds.	Código	EAN	P.V.P. (€)
14	340	200	1	P-70655	0088381364553	14,00
14	540	400	1	D-33906	0088381364560	19,00
16	340	200	1	P-70677	0088381364591	16,00
16	540	400	1	D-33940	0088381364607	20,50
18	340	200	1	P-70699	0088381364614	17,00
18	540	400	1	P-70708	0088381364621	22,00
20	320	200	1	P-70714	0088381364638	19,00
20	520	400	1	D-33984	0088381364645	25,50
22	320	200	1	P-70736	0088381364652	20,50
22	520	400	1	D-34001	0088381364669	28,00
24	320	200	1	P-70758	0088381364676	22,00
24	520	400	1	P-70764	0088381364683	29,50
25	320	200	1	D-34039	0088381364690	22,00

Ø (mm)	Comp. (mm)	Comp. útil (mm)	Unds.	Código	EAN	P.V.P. (€)
25	520	400	1	P-70786	0088381364706	29,00
28	370	250	1	D-34051	0088381364713	25,50
28	570	450	1	D-34067	0088381364720	39,00
30	570	450	1	D-34089	0088381364744	49,00
32	370	250	1	P-70839	0088381364751	42,00
32	570	450	1	D-34104	0088381364768	54,00
35	370	250	1	D-34110	0088381364775	51,50
35	570	450	1	D-34126	0088381364782	57,00
38	370	250	1	P-70873	0088381364799	63,00
38	570	450	1	D-34148	0088381364805	76,00
40	370	250	1	D-34154	0088381364812	70,50
40	570	450	1	D-34160	0088381364829	80,00



**Brocas para martelos SDS-MAX**



**4 vantagens significativas:**

1. Maior vida útil da broca.
2. Velocidade de perfuração superior do que as brocas convencionais.
3. Rápida remoção de pó o berbequim = poupança de tempo e dinheiro.
4. Menor vibração e energia directamente na ponta da broca = menor esforço.

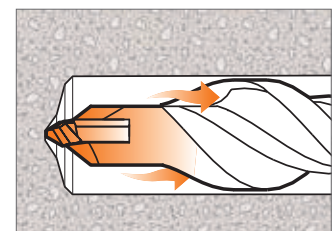

**Brocas MAK2**



**MAK 2**

Ø (mm)	Comp. (mm)	Comp. útil (mm)	Unds.	Código	EAN	P.V.P. (€)
12	340	200	1	P-17033	0088381943369	33,00
12	540	400	1	P-17049	0088381943376	42,00
12	690	550	1	P-17055	0088381943383	59,00
14	340	200	1	P-17077	0088381943406	37,00
14	540	400	1	P-17083	0088381943413	45,00
15	340	200	1	P-17108	0088381943437	37,00
15	540	400	1	P-17114	0088381943444	46,00





**Brocas de coroa para martelos SDS-MAX**

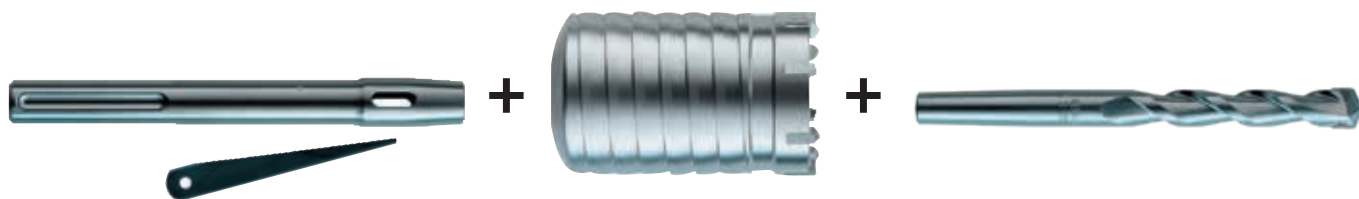

**BROCAS DE COROA  
IDEAIS PARA PERFURAR BETÃO E ALVENARIA:**

- Alinhamento assimétrico dos dentes.
- Espiral externa que reduz o peso em 8 %.
- Redução da espessura da parede do dente e dente chanfrado na coroa para melhor penetração no material.
- Duas ranhuras assimétricas para evacuar o pó.



**Brocas de coroa para martelos SDS-MAX**



Ø (mm)	Comp. (mm)	Unds.	Código	EAN	P.V.P. (€)
40	100	1	P-03779	0088381917438	91,00
50	100	1	P-03785	0088381917445	95,00
65	100	1	P-03791	0088381917452	116,00
80	100	1	P-03800	0088381917469	131,00
90	100	1	P-03816	0088381917476	154,00
100	100	1	P-03822	0088381917483	178,00
125	100	1	P-16374	0088381932394	257,00

**Broca centradora**



Ø (mm)	Comp. (mm)	Unds.	Código	EAN	P.V.P. (€)
11	120	1	P-03838	0088381917490	10,00

**Adaptadores**



Tipo	Comp. (mm)	Unds.	Código	EAN	P.V.P. (€)
Cónico	180	1	P-16994	0088381943321	46,00
Cónico	450	1	P-17005	0088381943338	64,00

**Cunha**



Unds.	Código	EAN	P.V.P. (€)
1	P-03763	0088381944960	9,40



**Brocas de campânula para martelos SDS-MAX**



Para uso em betão, alvenaria e pedra natural.

**As brocas de campânula Makita são a ferramenta moderna para os utilizadores profissionais. Uma broca de coração potente, desenvolvida para a última geração de martelos rotativos, garante uma perfuração eficiente e uma vida útil superior.**

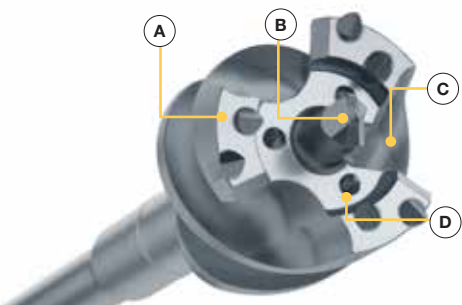

- A** Dentes de carboneto em forma de cinzel para uma penetração rápida no betão.
- B** Ponta central para maior precisão.
- C** Três saídas para remover grandes quantidades de pó e detritos.
- D** Três dentes adicionais de carboneto para demolir as pedras mais pequenas.

- **Menos vibrações.**
- **Mais leves.**
- **Tratamento térmico especial que aumenta a vida útil da broca.**
- **Construção de peça única para uma transmissão de potência perfeita.**

Ø (mm)	Comp. (mm)	Unds.	Código	EAN	P.V.P. (€)
45	550	1	E-20096	0088381519878	220,00
45	990	1	B-57641	0088381519885	233,00
55	550	1	E-20111	-	250,00
55	990	1	E-20127	-	285,00

Ø (mm)	Comp. (mm)	Unds.	Código	EAN	P.V.P. (€)
65	550	1	E-20133	-	270,00
65	990	1	B-57685	0088381519922	292,00
80	550	1	E-20155	-	300,00
80	990	1	B-57700	0088381519953	361,00

**Brocas de campânula modulares**

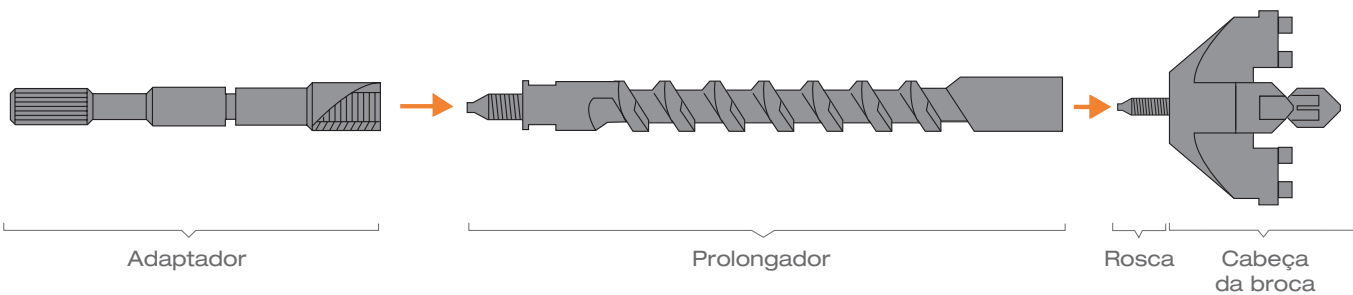

**Adaptadores**

Tipo	Comp. (mm)	Unds.	Código	EAN	P.V.P. (€)
SDS-MAX	195	1	P-03888	0088381917544	60,00
B	175	1	P-03894	0088381917551	50,00

**Prolongador**

Ø (mm)	Comp. (mm)	Unds.	Código	EAN	P.V.P. (€)
25	280	1	P-03925	0088381917582	97,00

**Rosca com mola para cabeça**

Ø (mm)	Comp. (mm)	Unds.	Código	EAN	P.V.P. (€)
50		1	P-03931	0088381917599	22,00

**Cabeça de broca**

Ø (mm)	Comp. (mm)	Modelo	Unds.	Código	EAN	P.V.P. (€)
35	150	HR4003C HR4013C	1	P-04008	0088381945028	138,00
40	150		1	P-03844	0088381917506	146,00
50	150		1	P-03850	0088381917513	178,00
55	150		1	P-04014	0088381945035	196,00
60	150	HR4003C HR4013C HR4501C HR4511C HR5202C HR5212C	1	P-04020	0088381945042	200,00
68	150		1	P-03866	0088381917520	220,00
80	150		1	P-03872	0088381917537	280,00
90	150		1	P-04036	0088381945059	396,00



P-03931



**MAK - Conexão SDS-MAX**

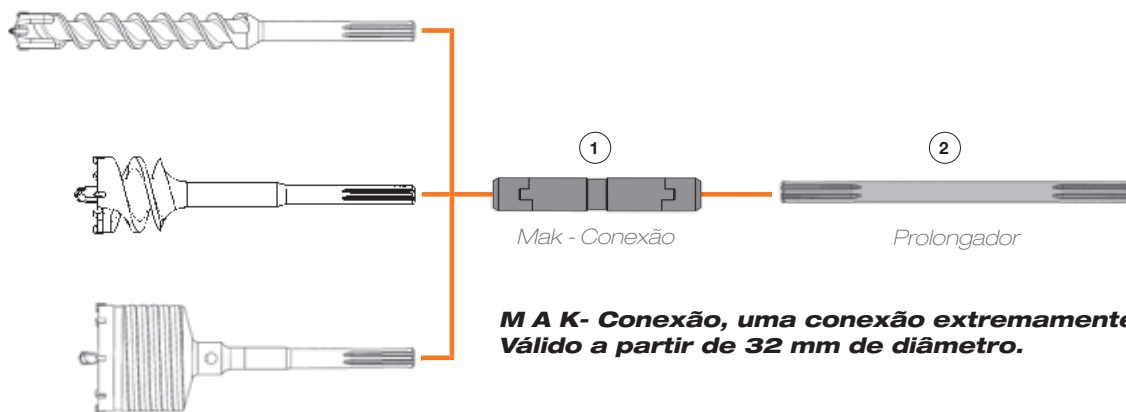

**MAK- Conexão, uma conexão extremamente robusta. Válido a partir de 32 mm de diâmetro.**

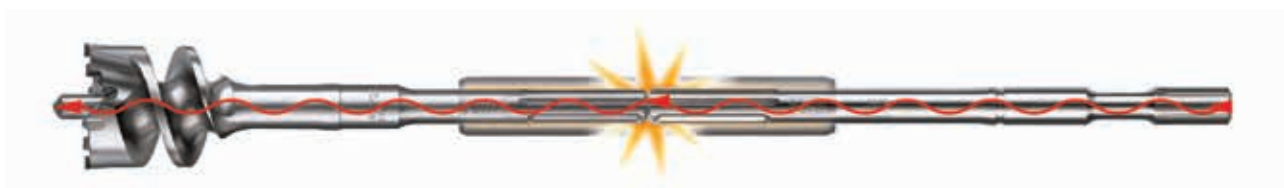

**Sistema de conexão para brocas, MAK-Conexão. Uma revolução no mundo da perfuração.**

Vantagens do sistema MAK-Connection:

- O sistema SDS - MAX, MAK-Connection, permite uma conexão segura e rápida entre a broca e o adaptador.
- Sem perdas de energia, ao contrário dos sistemas existentes. A potência total é transmitida para a broca.

**Adaptadores de inserção**



Descrição	Comp. (mm)	Acessório	Unds.	Código	EAN	P.V.P. (€)
Mak Conexão	-	SDS-MAX	1	P-53914	0088381984423	204,00
Prolongador	320		1	P-53920	0088381984430	29,00
Prolongador	750		1	P-53936	0088381984447	36,00
Prolongador	1100		1	P-53942	0088381984454	50,00

Descrição	Máquina	Acessório	Unds.	Código	EAN	P.V.P. (€)
Adaptador	K	SDS-MAX	1	P-02319	0088381944953	157,00
Adaptador	SDS-MAX	SDS-PLUS	1	P-17027	0088381943352	79,00



*Makita*

**XGT X2**  
**80V<sub>max</sub>**



**Sistemas  
de aspiração  
para martelos.**



**XGT**  
**40V<sub>max</sub> Li-ion**



**SDS-PLUS**

**Ponteiros**



- Para todo o tipo de trabalhos de alvenaria, betão e pedra solta.



B-64238

Largura (mm)	Comp. (mm)	Série	Unds.	Código	EAN	P.V.P. (€)
14	250	Premium ★★★★★	1	B-64238	0088381534444	12,20
14	250	Long life ★★★	1	B-64294	0088381534505	8,30
14	250	Standard ★★	1	D-08713	0088381179522	4,10
14	250	Long life ★★★	1	P-05505	0088381921299	9,90

**Cinzéis**



- Para todos os tipos de trabalhos de alvenaria, betão e pedra solta.



B-64244

Largura (mm)	Comp. (mm)	Série	Unds.	Código	EAN	P.V.P. (€)
20	250	Premium ★★★★★	1	B-64244	0088381534451	12,20
20	250	Long life ★★★	1	B-64303	0088381534512	8,30
20	250	Standard ★★	1	D-08729	0088381179539	3,90
22	250	Long life ★★★	1	P-05511	0088381921305	9,90

**Espátulas**



- Para a demolição universal de materiais de maior volume.



B-64250

Largura (mm)	Comp. (mm)	Série	Unds.	Código	EAN	P.V.P. (€)
40	250	Premium ★★★★★	1	B-64250	0088381534468	17,80
40	250	Long life ★★★	1	B-64319	0088381534529	12,30
40	250	Standard ★★	1	D-08735	0088381179546	5,20
40	250	Long life ★★★	1	P-05527	0088381921312	14,90
50	215	Standard ★★	1	D-25616	0088381338431	5,60

**Espátula para asfalto**



- Para trabalhos em estradas, por exemplo, reabilitação de superfícies ou outras reparações de estradas.



P-24935

Largura (mm)	Comp. (mm)	Série	Unds.	Código	EAN	P.V.P. (€)
60	250	Long life ★★★	1	P-24935	0088381951845	18,20

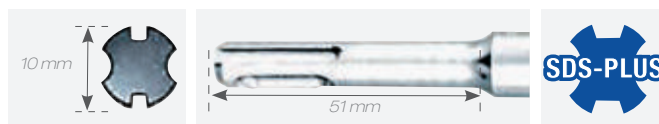

**Espátula dentada**



- Para renovar as paredes, remover a massa das juntas.



P-25096

Largura (mm)	Comp. (mm)	Série	Unds.	Código	EAN	P.V.P. (€)
32	200	Long life ★★★	1	P-25096	0088381952002	70,00

**Espátulas curvas**



- Remoção fácil e simples de azulejos (com extremidade angular ergonómica).



P-24941

Largura (mm)	Comp. (mm)	Série	Unds.	Código	EAN	P.V.P. (€)
40	200	Long life	1	P-24941	0088381951852	13,80
60	250	★★★	1	P-24957	0088381951869	19,30

**Escopro**



- Para fazer ranhuras em alvenaria.



P-05533

Largura (mm)	Comp. (mm)	Série	Unds.	Código	EAN	P.V.P. (€)
22	250	Long life ★★★	1	P-05533	0088381921329	16,00

**Escopro nervurado com alhetas**



- Para o tratamento de calcário, betão, tijolos, pedras-pomes, particularmente eficaz e seguro devido à sua profundidade de ranhura variável de 10-35 mm sem escorregar na ranhura.



P-24963

Largura (mm)	Comp. (mm)	Série	Unds.	Código	EAN	P.V.P. (€)
22	250	Long life ★★★	1	P-24963	0088381951876	28,00



**SDS-PLUS**

**Formões**



- Para trabalhos gerais de carpintaria, remoção rápida de material de madeira macia, por exemplo, para remoção de caixilhos de janelas antigas.



P-25111

Largura (mm)	Comp. (mm)	Série	Unds.	Código	EAN	P.V.P. (€)
20	170	Long life	1	P-25105	0088381952019	20,00
30	170	★★★	1	P-25111	0088381952026	27,00

**Conjunto de demolição**



Conteúdo	Unds.	Código	EAN	P.V.P. (€)
Ponteiro 14 x 250mm	1	D-05181	0088381177450	26,00
Cinzel 20 x 250mm	1			
Espátula 40 x 250mm	1			

**Raspador**



- Para levantar tapetes e remover adesivos de superfícies duras.



A-68161

Largura (mm)	Descrição	Tipo	Unds.	Código	EAN	P.V.P. (€)
100	Raspador	-	1	A-68161	0088381537254	86,00
-	Lâmina	Para A-68161	1	343411-9	0088381118415	31,00

**Conjunto de demolição**



Conteúdo	Unds.	Código	EAN	P.V.P. (€)
Ponteiro 14 x 250mm	2	D-16368	0088381187848	37,00
Cinzel 20 x 250mm	2			
Espátula 40 x 250mm	1			

**Conjunto de demolição**



Conteúdo	Unds.	Código	EAN	P.V.P. (€)
Ponteiro 250mm	1	D-42357	0088381404815	32,00
Cinzel 20 x 250mm	1			
Espátula 40 x 250mm	1			



**SDS-MAX**

**Ponteiros**



- Para todo o tipo de trabalhos de alvenaria, betão e pedra solta.



B-10366

Largura (mm)	Comp. (mm)	Série	Unds.	Código	EAN	P.V.P. (€)
18	280	Long life ★★★	1	P-16237	0088381932264	8,60
18	400		1	P-16243	0088381932271	12,70
18	600		1	P-16259	0088381932288	16,80
18	300	Standard ★★	1	D-34176	0088381364836	6,20
18	400		1	D-34182	0088381364843	7,80
18	400		10	D-34182-10	0088381367240	71,00
18	600		1	D-34198	0088381364850	10,00
18	400	Auto-afiável espiral ★★★★★	1	B-23064	0088381406161	21,00

**Cinzéis**



- Para todo o tipo de trabalhos de alvenaria, betão e pedra solta.



P-16265

Largura (mm)	Comp. (mm)	Série	Unds.	Código	EAN	P.V.P. (€)
25	280	Long life ★★★	1	P-16265	0088381932295	8,60
25	400		1	P-16271	0088381932301	12,70
25	600		1	P-16287	0088381932318	16,80
25	300	Standard ★★	1	D-34207	0088381364867	6,20
25	400		1	D-34213	0088381364874	8,10
25	400		10	D-34213-10	0088381367257	76,00
25	600		1	D-34229	0088381364881	9,60

**Conjunto de 5 ponteiros e 5 cinzéis**



Largura (mm)	Comp. (mm)	Série	Unds.	Código	EAN	P.V.P. (€)
18	400	Standard ★★	5	D-35324-10	0088381367905	57,00
25	400		5			

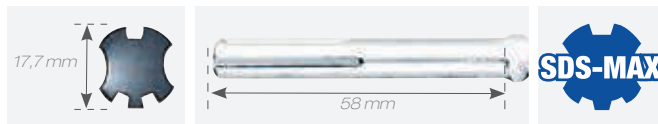

**Espátulas**



- Para a demolição em material de maior volume.



P-16302

Largura (mm)	Comp. (mm)	Série	Unds.	Código	EAN	P.V.P. (€)
50	350	Long life ★★★	1	P-16302	0088381932332	17,10
80	300		1	P-16318	0088381932349	26,00
50	400	Standard ★★	1	D-34235	0088381364898	8,80
80	300		1	D-34241	0088381364904	14,30

**Espátula curva**



- Remoção fácil e simples de azulejos. Com extremidade angular ergonómica.



P-16324

Largura (mm)	Comp. (mm)	Série	Unds.	Código	EAN	P.V.P. (€)
50	300	Long life ★★★	1	P-16324	0088381932356	26,00

**Espátula dentada**



- Para renovar as paredes, por exemplo, para remover massa das juntas.



P-16346

Largura (mm)	Comp. (mm)	Série	Unds.	Código	EAN	P.V.P. (€)
38	280	Long life ★★★	1	P-16346	0088381932370	66,00

**Escopro**



- Para fazer ranhuras em alvenaria.



P-16293

Largura (mm)	Comp. (mm)	Série	Unds.	Código	EAN	P.V.P. (€)
26	300	Long life ★★★	1	P-16293	0088381932325	27,00

**SDS-MAX**

**Escopro nervurado com alhetas**



- Para o tratamento de calcário, betão, tijolos, pedra-pomes, particularmente eficaz e seguro devido à sua profundidade de ranhura variável de 10-35 mm sem escorregar na ranhura.



Largura (mm)	Comp. (mm)	Série	Unds.	Código	EAN	P.V.P. (€)
35	380	Long life ★★★	1	P-16330	0088381932363	52,00

**Pá**



- Perfeita para cavar a terra.



Largura (mm)	Comp. (mm)	Série	Unds.	Código	EAN	P.V.P. (€)
110	400	Long life ★★★	1	P-23721	0088381950664	52,00

**Compactador**



- Para a compactação de materiais macios.



Adaptador



Compactador

Ø (mm)	Descrição	Série	Unds.	Código	EAN	P.V.P. (€)
140	Compactador	Long life ★★★	1	A-19875	0088381158985	89,00
-	Adaptador compactador	★★★	1	A-19897	0088381159005	43,00

**Bujarda**



- Para bujardar zonas de pedra ou de betão.



Adaptador



Base

Medida (mm)	Descrição	Série	Unds.	Código	EAN	P.V.P. (€)
60x60	Base	Long life ★★★	1	P-03947	0088381932820	82,00
250	Adaptador	★★★	1	P-16352	0088381932387	30,00

**Adaptador para tomadas de terra**

- Para cravar as placas na terra.



502024

Ø (mm)	Comp. (mm)	Série	Unds.	Código	EAN	P.V.P. (€)
13	260	Long life ★★★	1	502024	-	39,00
16	260		1	P-63797	0088381994316	44,00
19	260		1	502026	-	49,00
22,2	260		1	E-13041	0088381590211	61,00

**Estojos SDS-MAX**



Conteúdo	Série	Unds.	Código	EAN	P.V.P. (€)
Ponteiros	Standard ★★	2	D-40565	0088381403405	66,00
Cinzéis		2			
Espátulas		2			



Conteúdo	Série	Unds.	Código	EAN	P.V.P. (€)
Ponteiro	Standard ★★	1	D-42450	0088381404914	49,00
Cinzel		1			
Espátula		1			



## Makita Hexagonal 17mm

- Para modelos **HM0810T e HM0830T**

### Ponteiros



- Para todo o tipo de trabalhos de alvenaria, betão e pedra solta.



D-08682

Largura (mm)	Comp. (mm)	Série	Unds.	Código	EAN	P.V.P. (€)
17	280	Standard ★★	1	D-08682	0088381182911	3,60
17	450		1	D-16863	0088381192897	10,00
17	450	Long life ★★★	1	P-13041	0088381932844	22,00

### Espátulas



- Para a demolição em material de maior volume.



P-13079

Largura (mm)	Comp. (mm)	Série	Unds.	Código	EAN	P.V.P. (€)
50	280	Standard ★★	1	D-20694	0088381277709	5,60
45	280	Long life ★★★	1	P-13079	0088381932875	22,00

### Escopro nervurado com alhetas



- Para o tratamento de calcário, betão, tijolos, pedrapomes, particularmente eficaz e seguro devido à sua profundidade de ranhura variável de 10-35 mm sem escorregar na ranhura.



P-13100

Largura (mm)	Comp. (mm)	Série	Unds.	Código	EAN	P.V.P. (€)
35	380	Long life ★★★	1	P-13100	0088381932905	40,00

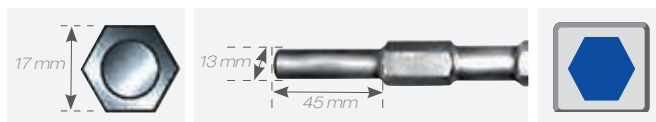

### Cinzéis



- Para todo o tipo de trabalhos de alvenaria, betão e pedra solta.



D-08707

Largura (mm)	Comp. (mm)	Série	Unds.	Código	EAN	P.V.P. (€)
19	280	Standard ★★	1	D-08707	0088381182935	5,90
19	450		1	D-16879	0088381192880	6,50
24	280	Long life ★★★	1	P-13057	0088381932851	16,00
24	450		1	P-13063	0088381932868	18,60

### Escopro curvo



- Para fazer ranhuras em alvenaria.



P-67393

Largura (mm)	Comp. (mm)	Série	Unds.	Código	EAN	P.V.P. (€)
26	280	Long life ★★★	1	P-67393	0088381997928	33,00



## B Hexagonal 19mm

- Para modelos **HR3520B, HR3850B, HR5000 e \*HM1200B.**

### Ponteiros



- Para todo o tipo de trabalhos de alvenaria, betão e pedra solta.



D-20074

Largura (mm)	Comp. (mm)	Série	Unds.	Código	EAN	P.V.P. (€)
19	300	Standard	1	D-20074	0088381256087	9,00
19	450	★★	1	D-19196	0088381253918	10,20
19	300	Long life	1	P-13122	0088381932912	16,40
19	450	★★★	1	P-13138	0088381932929	21,00

- Para modelo **HM1200B**



Ø (mm)	Comp. (mm)	Série	Unds.	Código	EAN	P.V.P. (€)
19	400	Long life	1	P-05620	0088381921411	16,50
19	600	★★★	1	P-05614	0088381921404	22,00

### Cinzéis



- Para todo o tipo de trabalhos de alvenaria, betão e pedra solta.



P-13144

Largura (mm)	Comp. (mm)	Série	Unds.	Código	EAN	P.V.P. (€)
24	300	Long life	1	P-13144	0088381932936	16,70
24	450	★★★	1	P-13150	0088381932943	20,00

- Para modelo **HM1200B.**



Largura (mm)	Comp. (mm)	Série	Unds.	Código	EAN	P.V.P. (€)
25	400	Long life	1	P-05636	0088381921428	15,60
25	600	★★★	1	P-05642	0088381921435	21,00

### Pá



- Para modelo **HM1200B.**



P-05670

Largura (mm)	Comp. (mm)	Série	Unds.	Código	EAN	P.V.P. (€)
105	400	Long life	1	P-05670	0088381921466	67,00

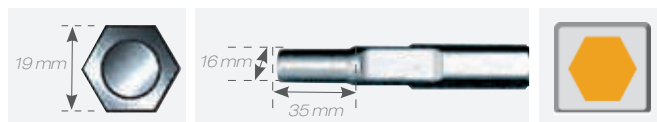

### Escopro curvo



- Para fazer ranhuras em alvenaria.



P-13188

Largura (mm)	Comp. (mm)	Série	Unds.	Código	EAN	P.V.P. (€)
22	250	Long life	1	P-13188	0088381932974	25,00

- Para modelo **HM1200B**



Largura (mm)	Comp. (mm)	Série	Unds.	Código	EAN	P.V.P. (€)
22	300	Long life	1	P-05658	0088381921442	25,00

### Escopro nervurado com alhetas



- Para o tratamento de calcário, betão, tijolos, pedrapomes, particularmente eficaz e seguro devido à sua profundidade de ranhura variável de 10-35 mm sem escorregar na ranhura.

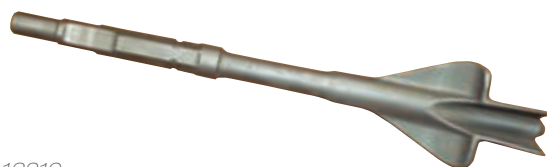

P-13219

Largura (mm)	Comp. (mm)	Série	Unds.	Código	EAN	P.V.P. (€)
35	380	Long life	1	P-13219	0088381932998	58,00

### Espátulas



- Para a demolição em material de maior volume.



P-13166

Largura (mm)	Comp. (mm)	Série	Unds.	Código	EAN	P.V.P. (€)
50	300	Long life	1	P-13166	0088381932950	29,00

- Para modelo **HM1200B.**



Largura (mm)	Comp. (mm)	Série	Unds.	Código	EAN	P.V.P. (€)
60	300	Long life	1	P-05664	0088381921459	31,00
60	450	★★★	1	P-05686	0088381921473	40,00



**Makita Hexagonal 21mm**

- Para modelo **HM1200**.

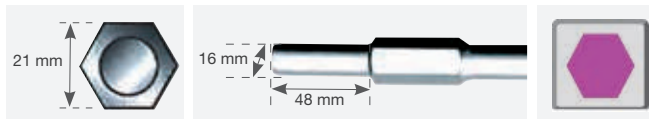

**Ponteiros**

- Para todo o tipo de trabalhos de alvenaria, betão e pedra solta.



P-13378

Largura (mm)	Comp. (mm)	Série	Unds.	Código	EAN	P.V.P. (€)
21	450	Standard ★★	1	D-23824	0088381312912	9,60
21	320	Long life ★★★	1	P-13378	0088381112468	19,00
21	450		1	P-13384	0088381943116	25,00
21	600		1	P-13390	0088381104432	26,00

**Cinzéis**

- Para todo o tipo de trabalhos de alvenaria, betão e pedra solta.



P-13409

Largura (mm)	Comp. (mm)	Série	Unds.	Código	EAN	P.V.P. (€)
24	320	Long life ★★★	1	P-13409	0088381943147	20,00
24	450		1	P-13415	0088381943154	26,00

**Pá**



798035-0

Largura (mm)	Comp. (mm)	Série	Unds.	Código	EAN	P.V.P. (€)
120	450	Long life ★★★	1	798035-0	0088381103558	98,00



## Makita Hexagonal 30mm

- Para modelos **HM1317C**, **HM1307C**, **\*HM1400**, **HM1501** e **HM1511**.

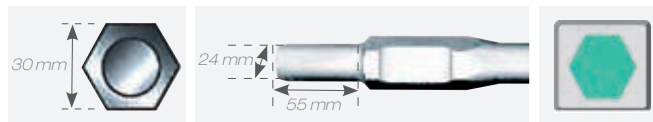

### Ponteiros

- Para todo o tipo de trabalhos de alvenaria, betão e pedra solta.



D-15285

Largura (mm)	Comp. (mm)	Série	Unds.	Código	EAN	P.V.P. (€)
30	410	Standard ★★	1	D-15285	0088381186377	17,70
30	400	Long life ★★★	1	P-05549	0088381921336	33,00
30	400		1	B-10388*	0088381342483	37,00
30	700		1	P-05561	0088381921350	48,00

\*autoafiação

### Espátulas

- Para a demolição em material de maior volume.



D-23868

Largura (mm)	Comp. (mm)	Série	Unds.	Código	EAN	P.V.P. (€)
75	310	Standard ★★	1	D-23868	0088381313094	23,00
75	310		1	D-34805*	0088381365802	23,00
115	400	Long life ★★★	1	P-13518	0088381943239	78,00

\*especial para solo.

- Para modelo **HM1400**.

Largura (mm)	Comp. (mm)	Série	Unds.	Código	EAN	P.V.P. (€)
110	400	Long life ★★★	1	P-13493	0088381943215	75,00



### Cinzéis

- Para todo o tipo de trabalhos de alvenaria, betão e pedra solta.



D-15300

Largura (mm)	Comp. (mm)	Série	Unds.	Código	EAN	P.V.P. (€)
30	400	Standard ★★	1	D-15300	0088381186384	18,40
32	410	Long life ★★★	1	P-13487	0088381943208	32,00

- Para modelo **HM1400**

Largura (mm)	Comp. (mm)	Série	Unds.	Código	EAN	P.V.P. (€)
32	400	Long life ★★★	1	P-13502	0088381943222	33,00
32	700		1	P-05583	0088381921374	47,00

### Compactador



A-31485

Ø (mm)	Série	Unds.	Código	EAN	P.V.P. (€)
200	Long life ★★★	1	A-31485	0088381151610	123,00

### Pá



A-31485

Largura (mm)	Comp. (mm)	Tipo	Unds.	Código	EAN	P.V.P. (€)
125	400	Long life ★★★	1	P-05555	0088381921343	81,00
120	500	Standar ★★	1	B-10300	0088381341288	106,00

- Para modelo **HM1400**

Largura (mm)	Comp. (mm)	Série	Unds.	Código	EAN	P.V.P. (€)
125	400	Long life ★★★	1	P-05608	0088381921398	62,00



**Makita Hexagonal 28,6mm**

- Para modelos **HM1317CB, HM1304B, HM1512, HM1801, HM1810 e HM1812.**



**Ponteiros**

- Para todo o tipo de trabalhos de alvenaria, betão e pedra solta.



P-05692

Largura (mm)	Comp. (mm)	Série	Unds.	Código	EAN	P.V.P. (€)
28,6	400	Long life	1	P-05692	0088381921480	30,00
28,6	600	★★★	1	P-64272	0088381994798	65,00
28,6	400	Premium ★★★★★	1	B-10372*	0088381342476	34,00

\*autoafável



D-17631

Largura (mm)	Comp. (mm)	Série	Unds.	Código	EAN	P.V.P. (€)
28,6	400	Long life	1	D-17631	0088381197182	20,00
28,6	600	★★★	1	P-65931	0088381996464	39,00

**Espátulas**

- Para a demolição em material de maior volume.



D-29228

Largura (mm)	Comp. (mm)	Série	Unds.	Código	EAN	P.V.P. (€)
75	410	Standard ★★	1	D-29228	0088381345682	21,00
80	400	Long life ★★	1	P-05701	0088381921497	52,00

**Pá**



P-05717

Largura (mm)	Comp. (mm)	Série	Unds.	Código	EAN	P.V.P. (€)
125	400	Long life ★★	1	P-05717	0088381921503	75,00

**Cinzéis**

- Para todo o tipo de trabalhos de alvenaria, betão e pedra solta.

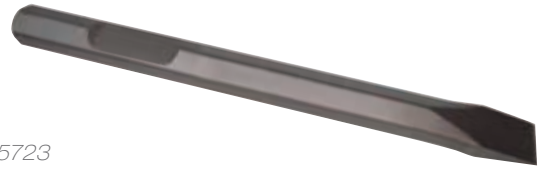

P-05723

Largura (mm)	Comp. (mm)	Série	Unds.	Código	EAN	P.V.P. (€)
35	400	Long life	1	P-05723	0088381921510	29,00
30	600	★★★	1	P-64288	0088381994804	50,00



P-65947

Largura (mm)	Comp. (mm)	Série	Unds.	Código	EAN	P.V.P. (€)
28	410	Standard ★★	1	D-17647	0088381197199	20,00
30	600	Long life ★★	1	P-65947	0088381996471	39,00

**Compactador**



798385-3

Ø (mm)	Série	Unds.	Código	EAN	P.V.P. (€)
200	Long life ★★	1	798385-3	0088381127554	217,00

- **Uso de ponteiro com anilha**

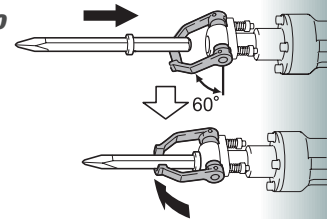

- **Uso de ponteiro com redução**

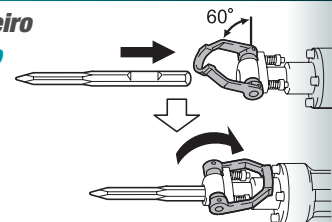



**K Hexagonal 21mm**

- Para modelos K.

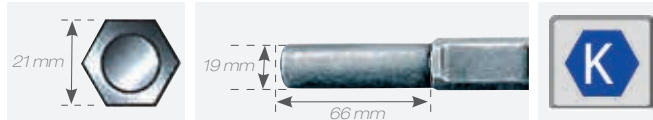

**Ponteiros**



- Para todo o tipo de trabalhos de alvenaria, betão e pedra solta.

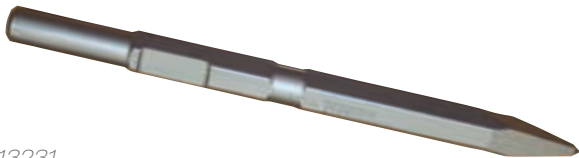

P-13231

Largura (mm)	Comp. (mm)	Série	Unds.	Código	EAN	P.V.P. (€)
21	300	Long life	1	P-13231	0088381933001	19,30
21	460	★★★	1	P-13253	0088381943024	25,00

**Cinzéis**



- Para todo o tipo de obras de alvenaria, betão e pedra solta.



P-13275

Largura (mm)	Comp. (mm)	Série	Unds.	Código	EAN	P.V.P. (€)
25	300	Long life ★★★	1	P-13275	0088381126717	19,30
25	460		1	P-13297	0088381943062	22,00
25	600		1	P-13306	0088381943079	29,00

**Espátulas**



- Para a demolição em material de maior volume.



P-13312

Largura (mm)	Comp. (mm)	Série	Unds.	Código	EAN	P.V.P. (€)
75	300	Long life ★★★	1	P-13312	0088381943086	33,00

**Escopro nervurado com alhetas**



- Para o tratamento de calcário, betão, tijolos, pedrapomes, particularmente eficaz e seguro devido à sua profundidade de ranhura variável de 10-35 mm sem escorregar na ranhura.

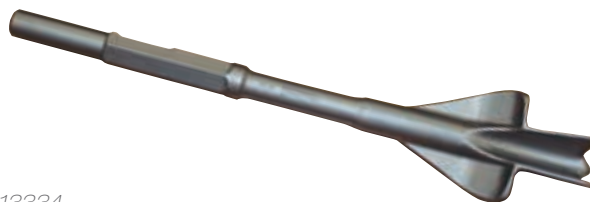

P-13334

Largura (mm)	Comp. (mm)	Série	Unds.	Código	EAN	P.V.P. (€)
35	380	Long life ★★★	1	P-13334	0088381943109	58,00

**HM1812**

**Sistema anti-vibração AVT**  
**Carcasa anti-vibração**  
**4 molas e modo ralenti**



## Makita Hexagonal 19mm

- Para modelo **HK1810**

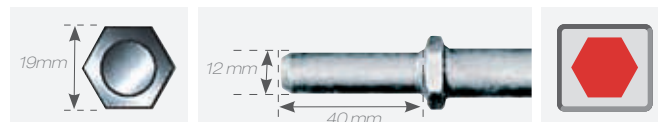

### Ponteiro



- Para todo o tipo de trabalhos de alvenaria, betão e pedra solta.



Largura (mm)	Comp. (mm)	Série	Unds.	Código	EAN	P.V.P. (€)
19	220	Long life ★★★	1	B-06921	0088381313292	14,30

### Cinzel



- Para todo o tipo de trabalhos de alvenaria, betão e pedra solta.



Largura (mm)	Comp. (mm)	Série	Unds.	Código	EAN	P.V.P. (€)
20	220	Long life ★★★	1	B-07004	0088381313308	17,90

### Cinzéis curvos



- Remoção fácil e simples de azulejos (com extremidade angular ergonómica).



Largura (mm)	Comp. (mm)	Série	Unds.	Código	EAN	P.V.P. (€)
35	190	Long life ★★★	1	P-05496	0088381921282	26,00
50	190		1	P-05474	0088381921268	27,00

### Espátula



- Para a demolição em material de maior volume.



Largura (mm)	Comp. (mm)	Série	Unds.	Código	EAN	P.V.P. (€)
50	220	Long life ★★★	1	B-07010	0088381313315	20,00

### Raspador



Largura (mm)	Tipo	Unds.	Código	EAN	P.V.P. (€)
100	Raspador completo	1	A-68155	0088381114882	71,00
100	Lâmina	1	343411-9	0088381118415	31,00

### Escopro



Largura (mm)	Série	Unds.	Código	EAN	P.V.P. (€)
45	Long life ★★★	1	P-05480	0088381921275	30,00



Makita

**Conjunto eixo - mandril para martelos SDS-MAX**



Descrição	Rosca	Inserção	Unds.	Código	EAN	P.V.P. (€)
Conjunto	1/2"	SDS-MAX	1	122829-5	0088381435901	65,00

**Porta-brocas e porta-ferramentas para martelos ligeros**



Porta-brocas automático



Porta-ferramenta SDS-PLUS

Descrição	mm	Modelos	Unds.	Código	EAN	P.V.P. (€)
Porta-brocas	13	DHR243 DHR263 HR002G HR2630T HR2631FT HR2810T HR2811FT	1	194079-2	0088381196826	64,00
	13	DHR281 DHR283	1	199139-5	0088381525695	55,00
	13	HR3210FCT	1	194568-7	0088381347389	74,00
	13	HR008G HR3012	1	191F46-4	0088381560795	55,00
Porta-ferramentas SDS-PLUS	-	DHR243 DHR263 HR2630T HR2631FT HR2810T HR2811FT	1	194080-7	0088381196833	33,00
	-	DHR281 DHR283	1	199138-7	0088381525718	24,00
	-	HR3210FCT	1	125420-8	3240890170774	59,00
	-	HR3012	1	191F47-2	0088381560801	34,00



**Gancho**



Descrição	Unds.	Código	EAN	P.V.P. (€)
Gancho	1	191W90-3	-	10,50

**Conjunto eixo - mandril para martelos SDS-PLUS**



P-18150



D-14093

com porta-brocas

Descrição	Rosca	Inserção	Unds.	Código	EAN	P.V.P. (€)
Conjunto	1/2"	SDS-PLUS	1	P-18150	0088381944472	47,00
Adaptador	1/2"	SDS-PLUS	1	D-14093	0088381359450	2,80

**Soprador de pó**



Unds.	Código	EAN	P.V.P. (€)
1	765009-6	0088381102377	2,45

**Óleo grafitado**



Conteúdo (gr)	Unds.	Código	EAN	P.V.P. (€)
30	1	P-08361	0088381913072	3,30

**Pano de limpeza**



Unds.	Código	EAN	P.V.P. (€)
1	443122-7	0088381205658	3,30

**Lubrificante para broca**



198993-4



183477-5

Conteúdo (gr)	Unds.	Código	EAN	P.V.P. (€)
30	1	183477-5	0088381373760	4,10
100	1	198993-4	0088381518994	6,60



## Sistemas de proteção contra o pó

A Makita cuida da saúde e do conforto de trabalho dos nossos utilizadores todos os dias, e um dos maiores perigos é a inalação de pó mineral.



A longo prazo, pode causar graves problemas respiratórios, por isso é essencial agir sobre este problema.

Para isso, a Makita desenvolveu uma gama completa de acessórios de aspiração para conexão à maioria dos nossos martelos ligeiros

O pó não é algo que se possa varrer para debaixo do tapete, é algo perigoso que pode afetar a sua saúde. **Tome medidas!**

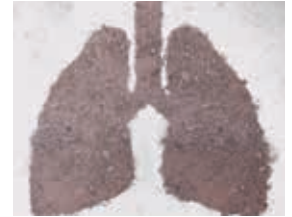

## Coletores de pó aspiração automática



Tipo	Modelos	Medidas (mm)	Unds.	Código	EAN	P.V.P. (€)
DX06	DHR242	372 x 88 x 287	1	199563-2	0088381540346	126,00
DX02	DHR243	397 x 88 x 287	1	195902-4	0088381400626	122,00
DX05	DHR182	431 x 82 x 285	1	199664-6	0088381540315	97,00
DX08	"DHR280 DHR282"	435 x 86 x 306	1	199581-0	0088381540827	155,00
DX09	"DHR281 DHR283"	457 x 86 x 306	1	199585-2	0088381540865	155,00
DX10	HR3011FC	592 x 145 x 242	1	191F95-1	0088381565752	121,00
DX11	HR3012FC	661 x 145 x 242	1	191G00-4	0088381565806	121,00
DX12	HR001G HR003G	425 x 86 x 306	1	191E54-9	0088381560047	171,00



## Filtro para DX01, DX02, DX03, DX05, DX08, DX09 e DX12

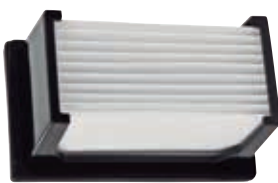

Válido	Descrição	Unds.	Código	EAN	P.V.P. (€)
DX01 DX02 DX08 DX09 DX12	Filtro HEPA	1	199557-7	0088381539784	11,80
DX03	Conjunto alojamento de filtro	1	196162-1	0088381413220	32,00
DX05	Filtro HEPA	1	199596-7	0088381541466	9,40
DX10 DX11	Conjunto caixa coletor de pó	1	191F49-8	0088381560818	52,00



## Coletores de pó para martelos ligeiros



Modelo	Unds.	Código	EAN	P.V.P. (€)
HR007G	1	191X40-4	-	121,00



**Extrator de pó**



Modelos	Unds.	Código	EAN	P.V.P. (€)
HR2230 HR2460 HR2470	1	193472-7	0088381174022	49,00

**Coletor de pó para martelos SDS-PLUS**



Modelos	Unds.	Código	EAN	P.V.P. (€)
DHR171 DHR182 DHR202 DHR263 HR140D HR166D HR1830 HR1841F HR2230 HR2470 HR2800 HR2810 HR2811	1	198362-9*	0088381483636	11,80

\* Utilizar com adaptador.

**Adaptadores para uso com coletor de pó 198362-9**

Modelos	Unds.	Código	EAN	P.V.P. (€)
DHR165 DHR171 DHR182 HR1830 HR140D HR166D HR1841F	1	194581-5	0088381371599	14,30
DHR202 DHR263 HR2810T HR2811FT	1	194582-3	0088381367219	5,50
HR2230 HR2460 HR2470	1	194583-1	0088381367226	5,10
HR3011 HR3012	1	191L91-5	0088381567411	6,00

**Saco de pó**



Modelos	Unds.	Código	EAN	P.V.P. (€)
HR2430	1	193976-9	0088381191333	14,30
HR2432	1	122708-7	0088381202992	9,00

**Tampas para o pó**



Tipo 1

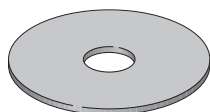

Indicado para	Tipo	Unds.	Código	EAN	P.V.P. (€)
Brocas 6 a 14 mm. Ø	1	1	421342-3	0088381116602	2,45
Brocas 12 a 16 mm. Ø	1	1	421664-1	0088381149754	3,90
HK1810	2	1	423154-0	0088381123846	0,80

**Coletor de pó para martelos SDS-PLUS**



Possibilidade de conectar dois coletores para aspirar quando são utilizadas brocas mais longas.

Modelos	Unds.	Código	EAN	P.V.P. (€)
DHR242 DHR280 DHR282 HR2630 HR2600 HR2300	1	195173-3	0088381361125	7,50
DHR243 DHR281 DHR283 HR2611FT HR2630T	1	195179-1	0088381361194	9,00

**Adaptador 1/2" para SDS-MAX (para remover brocas presas)**



\* Utilizar com chaves de impacto de 1/2".

Tipo	Unds.	Código	EAN	P.V.P. (€)
1/2"	1	195870-1	0088381398336	110,00



Coletores de pó para martelos combinados



Kit

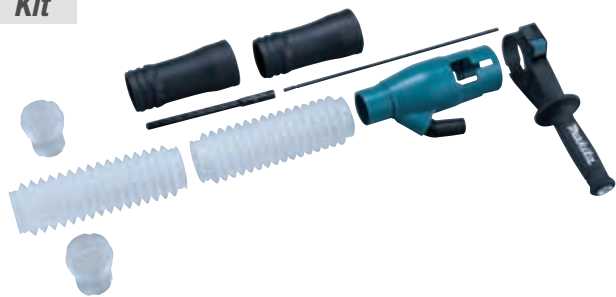

Modelos	Unds.	Código	EAN	P.V.P. (€)
HR4001C HR4011C HR4501C HR4511C	1	196074-8	0088381407632	112,00
HR5212C	1	196858-4	0088381441599	82,00
DHR400 HR4003C HR4013C	1	199142-6	0088381524339	107,00

Makita



Coletores de pó para martelos demolidores



Modelos	Unds.	Código	EAN	P.V.P. (€)
HM002G	1	199143-4	0088381524346	20,00
HM1307C HM1317C HM1400 HM1812	1	197168-2	0088381449984	57,00
HM1501	1	191M20-4	0088381575713	67,00



**Punhos**

**Tipo 1**

\* Apenas punho



**Tipo 2**

\* Punho completo



Modelos	Unds.	Código	EAN	P.V.P. (€)
HR2800 HR2230 HR2460 HR2470 HR2810 HR2811	1	158057-6	3240890278531	4,90
HR2510	1	273496-0	3240890119971	12,10
HR3000C HM0860C HM0830T	1	152554-4	0088381156318	9,10
HR3520B HR3850B HR5000K	1	273472-4	0088381115841	11,00
HR4000C HR4001C HR4011C	1	134803-1	0088381144384	30,00
HR4501C HR4511C HR5201C HR5211C	1	158131-0	0088381346115	11,00
HM0810T HR3850B HR3520B	1	273457-0	0088381123440	11,60

Modelos	Unds.	Código	EAN	P.V.P. (€)
HR3520B HR3850B HR5000 HR5000K	1	134887-9	0088381151474	40,00
HR4000C HR4001C HR4011C HR4501C HR4511C HM1111C HM1101C HR3540C HR3541FC	1	134890-0	0088381152266	36,00
HR4500C	1	134915-0	0088381160087	30,00
HR5001C	1	134945-1	0088381164979	30,00
HR5201C HR5211C HM1202C HM1203C HM1213C	1	135269-8	0088381359528	42,00
HM1200K	1	134944-3	0088381200998	24,00
HM0860C HM0830T HM0870C HM0871C HM1100C HM1200 HM1200B	1	134909-5	0088381164962	28,00
HM1214C HR5202C HR5212C	1	135283-4	0088381359771	41,00
HR4003C	1	196792-8	0088381568678	27,00

**Tipo 3**

\* Punho completo



Modelos	Unds.	Código	EAN	P.V.P. (€)
DHR280	1	126882-3	-	16,40
DHP458	1	123257-7	3240890407412	14,00
DHP481	1	122D11-0	-	33,00
HM001G HM0870C HM0871C	1	135332-7	0088381367196	24,00
HR2020 HR2440 HR2450 HR2432	1	135302-6	0088381364430	4,00
HR2300 HR2600 HR2610 HR2610T HR2611FT	1	122878-2	0088381401463	14,00
HR3000C	1	134889-5	0088381152297	22,00
HR3200C HR3210C/FCT	1	135197-7	0088381349710	22,00
HR3540C HR3541FC HR4001C HR4011C HR4501C HR4511C	1	135209-6	0088381361828	22,00
HR4500C	1	134916-8	0088381160094	25,00
HR5001C	1	134881-1	0088381152921	28,00
HR5201C HR5211C	1	135380-6	0088381366243	25,00

**Tipo 1**



**Tipo 2**



**Tipo 3**





# Furar

- Metal
- Madeira
- Alvenaria
- Vidro

# Escarear

# Bater



## *Ezychange*

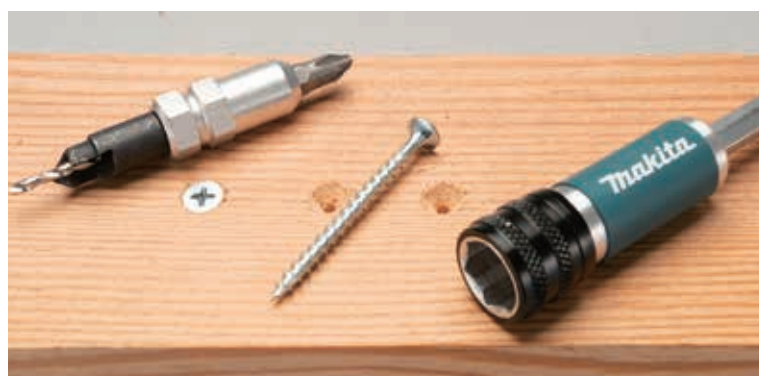

**Brocas de coroa Unicut para alvenaria e azulejo**

**Broca de coroa**



Ø (mm)	Comp. (mm)	Modelos	Unds.	Código	EAN	P.V.P. (€)
25	60	Martelos ligeiros até 26 mm	1	P-64462	0088381994989	31,00
30	60		1	P-64478	0088381994996	31,00
35	60		1	P-64484	0088381995009	35,00
40	60		1	P-64490	0088381995016	36,00
45	60		1	P-64509	0088381995023	37,00
50	60		1	P-64515	0088381995030	39,00
55	60		1	P-64521	0088381995047	41,00
58	60		1	P-64537	0088381995054	45,00
60	60		1	P-64543	0088381995061	45,00
63	60		1	P-64559	0088381995078	45,00
65	60		1	P-64565	0088381995085	46,00
68	60		1	P-64571	0088381995092	49,00
70	60		1	P-64587	0088381995108	56,00
71	60		Martelo ligeiros a partir de 28 mm	1	P-64593	0088381995115
74	60	1		P-64602	0088381995122	58,00
76	60	1		P-64618	0088381995139	59,00
80	60	1		P-64630	0088381995153	61,00
85	60	1		P-64646	0088381995160	66,00
90	60	1		P-64652	0088381995177	68,00
105	60	1		P-64668	0088381995184	89,00

**Adaptador para brocas UNICut**



Ø (mm)	Comp. (mm)	Unds.	Código	EAN	P.V.P. (€)
M16	118	1	P-64319	0088381994835	30,00
M16	370	1	P-64331	0088381994859	36,00

**Broca centradora para brocas Unicut**



Ø (mm)	Comp. (mm)	Ponta	Unds.	Código	EAN	P.V.P. (€)
8	120	TCT	1	P-64347	0088381994866	6,70

**UNICut**

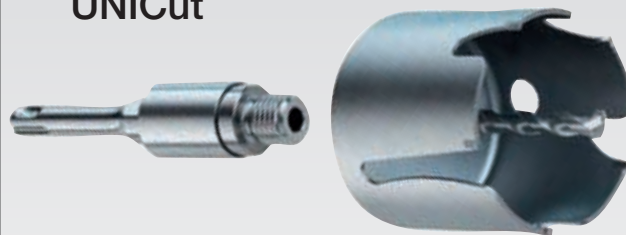

As brocas UNICut são projetadas para utilização numa ampla gama de materiais:

- Alvenaria, tijolos, azulejos, etc.
- Materiais leves como gesso cartonado, tabique, Fermacell, etc.
- Em plástico, madeira prensada, contraplacado, etc.

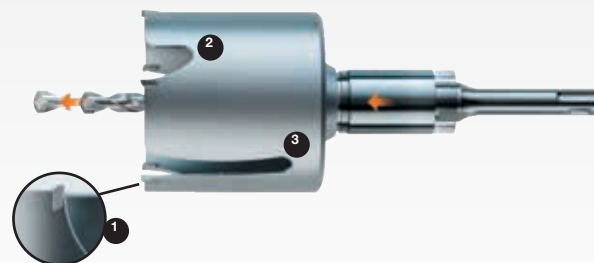

**UNICut - vantagens convincentes!**

- 1 Robusta e duradora:** Os dentes de carboneto, com uma superfície mais ampla, soldados (1) de forma segura, asseguram e garantem que os dentes não se soltarão da broca.
- 2 Rápida progressão ao furar:** graças à estrutura robusta e ao corte agressivo.
- 3 Otimizando a vida do corpo:** A vibração foi melhorada graças à geometria especial das câmaras de evacuação ampliadas (2) e da ranhura de extração de gases (3).



**Brocas para tijolo** ★★



Ø (mm)	Comp. (mm)	Unds.	Código	EAN	P.V.P. (€)
3	60	1	D-05228	0088381176453	1,25
4	70	1	D-05234	0088381176460	1,25
5	85	1	D-05240	0088381176477	1,25
6	100	1	D-05256	0088381176484	1,25
6	150	1	D-05262	0088381176491	1,25
7	100	1	D-05278	0088381176507	1,25
7	150	1	D-05284	0088381176514	1,25
8	110	1	D-05290	0088381176521	1,25
8	150	1	D-05309	0088381176538	1,25
9	150	1	D-05315	0088381176545	1,25
10	150	1	D-05321	0088381176552	1,55
11	150	1	D-05337	0088381176569	1,55
12	150	1	D-05343	0088381176576	2,15
13	150	1	D-05359	0088381176583	2,80
14	150	1	D-05365	0088381176590	2,80
15	150	1	D-05371	0088381176606	2,80
16	150	1	D-05387	0088381176613	3,10

**Brocas para tijolo TCT** ★★★



Ø (mm)	Comp. (mm)	Unds.	Código	EAN	P.V.P. (€)
3	60	1	E-06351	0088381569309	1,50
4	70	1	E-06367	0088381569316	1,50
5	85	1	E-06373	0088381569323	1,50
5	150	1	E-06389	0088381569330	1,50
6	100	1	E-06410	0088381569361	1,50
6	150	1	E-06426	0088381569378	1,50
8	110	1	E-06482	0088381569439	1,50
8	150	1	E-06498	0088381569446	1,50
10	150	1	E-06529	0088381569477	1,50
10	250	1	E-06535	0088381569484	3,05
12	150	1	E-06541	0088381569491	2,40
12	250	1	E-06557	0088381569507	3,30
14	150	1	E-06563	0088381569514	3,05
14	250	1	E-06579	0088381569521	4,20
16	150	1	E-06585	0088381569538	3,40
18	200	1	E-06591	0088381569545	4,90
20	200	1	E-06600	0088381569552	5,50

**Brocas para tijolo 1/4" hexagonal** ★★



Ø (mm)	Comp. (mm)	Unds.	Código	EAN	P.V.P. (€)
5	90	1	D-23793	0088381312882	2,10
6	100	1	D-23802	0088381312899	2,15
8	100	1	D-23818	0088381312905	2,90

**Brocas para vidro 1/4" hexagonal** ★★★

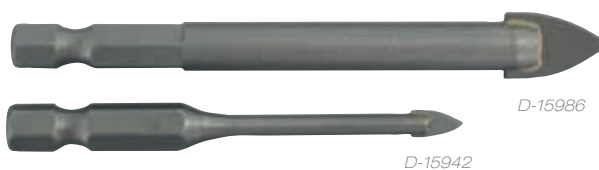

Ø (mm)	Comp. (mm)	Unds.	Código	EAN	P.V.P. (€)
4	65	1	D-15942	0088381187107	2,80
5	65	1	D-15958	0088381187114	2,80
6	65	1	D-15964	0088381187121	3,05
8	70	1	D-15970	0088381187138	3,05
10	80	1	D-15986	0088381187145	3,70



**Brocas multimaterial**

Omn|Bohrer

★★



Ø (mm)	Comp. (mm)	Comp. útil (mm)	Unds.	Código	EAN	P.V.P. (€)
3	60	26	1	D-30287	0088381353151	0,90
4	70	36	1	D-30293	0088381353168	0,90
5	85	41	1	D-30302	0088381353175	0,90
5,5	100	56	1	D-31033	0088381355056	0,90
6	150	101	1	D-30324	0088381353199	0,95
6	250	170	1	D-72780	0088381577298	1,80
6,5	100	56	1	D-31061	0088381355087	0,95
7	150	101	1	D-30346	0088381353212	1,25
8	150	95	1	D-30368	0088381353236	1,25
9	150	95	1	D-30374	0088381353243	1,50
10	150	95	1	D-30380	0088381353250	1,55
12	150	91	1	D-30411	0088381353281	2,15
12	400	298	1	D-30427	0088381353298	4,60
13	150	83	1	D-30449	0088381353342	2,45
14	150	83	1	D-30455	0088381353311	2,80
14	400	298	1	D-30461	0088381353328	6,20

**Brocas multimaterial**

Omn|Bohrer

★★★



Ø (mm)	Comp. (mm)	Comp. útil (mm)	Unds.	Código	EAN	P.V.P. (€)
3	70	38	1	E-10958	0088381581615	1,60
4	75	40	1	E-10964	0088381581622	1,60
5	85	43	1	E-10970	-	1,70
5,5	100	50	1	E-10986	0088381581646	1,85
6	150	90	1	E-11003	0088381581660	2,20
6,5	150	90	1	E-11025	0088381581684	2,35
7	100	50	1	E-11031	0088381581691	2,20
8	150	90	1	E-11053	0088381581714	2,95
10	150	90	1	E-11069	0088381581721	3,50
12	150	90	1	E-11075	0088381581738	3,90
13	150	90	1	E-11081	0088381581745	4,80

**Brocas multimaterial**

Omn|Bohrer

Inserção 1/4" Hex

★★★



E-14934

E-14255

E-14255

Ø (mm)	Comp. (mm)	Unds.	Código	EAN	P.V.P. (€)
4/5/6/8/10 (estojo)	75/85/100/120/150	1	E-14255	0088381593526	12,80
3	90	1	E-14934	0088381594899	1,85
4	90	1	E-14940	0088381594905	1,85
5	100	1	E-14956	0088381594912	2,15
6	100	1	E-14984	0088381594943	2,40
6	150	1	E-14990	0088381594950	2,65
8	120	1	E-15045	0088381595001	3,20
8	150	1	E-15051	0088381595018	3,50
10	150	1	E-15067	0088381595025	4,00
12	150	1	E-15073	0088381595032	4,50
13	150	1	E-15089	0088381595049	5,40



## Brocas standard para madeira

- Com ponta centralizadora. ★★★



Ø (mm)	Comp. (mm)	Comp. útil (mm)	Unds.	Código	EAN	P.V.P. (€)
3	60	33	1	D-07026	0088381178587	0,95
4	75	43	1	D-07032	0088381178594	0,95
5	85	52	1	D-07048	0088381178600	0,95
6	95	57	1	D-07054	0088381178617	0,90
6	315	160	1	D-07157	0088381178716	3,30
7	110	69	1	D-07060	0088381178624	1,25
8	115	75	1	D-07076	0088381178631	1,25
8	315	160	1	D-07163	0088381178723	3,60
9	125	81	1	D-07082	0088381178648	1,55
10	135	87	1	D-07098	0088381178655	1,55
10	315	160	1	D-07179	0088381178730	4,40
12	155	101	1	D-07107	0088381178662	2,20
12	315	160	1	D-07185	0088381178747	5,30
13	151	96	1	D-53453	0088381449373	2,85
14	170	108	1	D-07113	0088381178679	2,80
14	315	160	1	D-07191	0088381178754	6,30
15	160	100	1	D-53469	0088381449380	3,50
16	180	105	1	D-07129	0088381178686	4,40
16	315	160	1	D-07200	0088381178761	7,50
18	200	120	1	D-07135	0088381178693	6,30
18	335	160	1	D-07216	0088381178778	10,10
20	200	130	1	D-07141	0088381178709	6,90
20	335	160	1	D-07222	0088381178785	12,60

## Brocas standard para madeira 1/4" hexagonal



Ø (mm)	Comp. (mm)	Comp. útil (mm)	Unds.	Código	EAN	P.V.P. (€)
3	75	33	1	D-15861	0088381187022	1,25
4	90	43	1	D-15877	0088381187039	1,25
5	100	52	1	D-15883	0088381187046	1,55
6	110	57	1	D-15899	0088381187053	1,55
8	115	75	1	D-15908	0088381187060	2,20
10	130	87	1	D-15914	0088381187077	2,50
12	150	101	1	D-15920	0088381187084	3,40
15	160	108	1	D-15936	0088381187091	5,40

## Brocas helicoidais para madeira

- Ideal para furos passantes.
- Ótima extração de aparas.
- Ponta autorroscante. ★★★



Ø (mm)	Comp. (mm)	Comp. útil (mm)	Unds.	Código	EAN	P.V.P. (€)
6	250	180	1	D-07331	0088381178891	3,50
8	250	180	1	D-07347	0088381178907	3,60
8	450	380	1	D-07559	0088381179119	7,60
10	250	180	1	D-07353	0088381178914	5,60
10	450	380	1	D-07565	0088381179126	8,20
12	250	180	1	D-07369	0088381178921	6,10
12	450	380	1	D-07571	0088381179133	9,40
13	250	180	1	D-53475	0088381449397	6,40
13	450	380	1	D-53497	0088381449410	10,20
14	250	180	1	D-07375	0088381178938	7,00
14	450	380	1	D-07587	0088381179140	10,20
15	250	180	1	D-53481	0088381449403	7,00
15	450	380	1	D-53506	0088381449427	11,40
16	250	180	1	D-07381	0088381178945	7,30
16	450	380	1	D-07593	0088381179157	11,90
18	250	180	1	D-07397	0088381178952	8,20
18	450	380	1	D-07602	0088381179164	13,40
20	250	180	1	D-07406	0088381178969	8,50
20	450	380	1	D-07618	0088381179171	15,30
22	250	180	1	D-07412	0088381178976	9,00
22	450	380	1	D-07624	0088381179188	16,90
24	250	180	1	D-07428	0088381178983	9,60
24	450	380	1	D-07630	0088381179195	18,90
26	450	380	1	D-07646	0088381179201	22,00
28	450	380	1	D-07652	0088381179218	25,00
30	450	380	1	D-07668	0088381179225	29,00

## Brocas helicoidais para madeira 1/4" hexagonal



Ø (mm)	Comp. (mm)	Comp. útil (mm)	Unds.	Código	EAN	P.V.P. (€)
6	200	130	1	D-15992	0088381187152	4,30
8	200	130	1	D-16003	0088381187169	4,90
10	200	130	1	D-16019	0088381187176	5,80
12	200	130	1	D-16025	0088381187183	6,20
14	200	130	1	D-16031	0088381187190	6,10
16	200	130	1	D-16047	0088381187206	6,30
18	200	130	1	D-16053	0088381187213	7,00
20	200	130	1	D-16069	0088381187220	8,10
21	200	130	1	D-16075	0088381187237	10,20



## Brocas de pala para madeira

- Com ponta centralizadora.
- Alta velocidade de perfuração.

★★



Ø (mm)	Comp. (mm)	Unds.	Código	EAN	P.V.P. (€)
6	150	1	D-07674	0088381179232	1,55
8	150	1	D-07680	0088381179249	1,55
10	150	1	D-07696	0088381179256	1,55
12	150	1	D-07705	0088381179263	1,85
13	150	1	D-67614	0088381549363	1,85
14	150	1	D-07711	0088381179270	1,85
15	150	1	D-07727	0088381179287	1,85
16	150	1	D-07733	0088381179294	1,85
18	150	1	D-07749	0088381179300	2,20
20	150	1	D-07755	0088381179317	2,20
22	150	1	D-07761	0088381179324	2,20
24	150	1	D-07777	0088381179331	2,85
25	150	1	D-07783	0088381179348	2,85
26	150	1	D-07799	0088381179355	2,85
28	160	1	D-07808	0088381179362	3,10
30	160	1	D-07814	0088381179379	3,40
32	160	1	D-07820	0088381179386	3,80
34	160	1	D-07836	0088381179393	4,10
35	160	1	D-07842	0088381179409	4,10
36	160	1	D-07858	0088381179416	4,40



## Brocas de precisão Forstner para madeira

- Perfurações perfeitas, com menos rebarbas.
- Menos ruído.
- Menos esforço.
- Fornecidas em recipiente de plástico com um gancho para pendurar.
- O desenho dos dentes oferece alta precisão e alto desempenho.
- Ponta centralizadora para precisão inicial da perfuração.
- Medição marcada na broca para fácil reconhecimento.
- Pode ser usada em berbequins com porta-brocas de 10 mm e 13 mm.

★★



Ø (mm)	Comp. (mm)	Unds.	Código	EAN	P.V.P. (€)
10	90	1	D-41844	0088381404648	6,60
15	90	1	D-41925	0088381404686	7,80
20	90	1	D-42232	0088381404693	8,90
25	90	1	D-42248	0088381404709	9,60
26	90	1	D-42254	0088381404716	10,20
30	90	1	D-42260	0088381404723	10,70
35	90	1	D-42282	0088381404747	11,90
40	90	1	D-42298	0088381404754	13,70
50	90	1	D-42307	0088381404761	18,80



Makita

### Brocas autoalimentadas para madeira

- A ponta do parafuso roscado empurra a broca em direção à peça de trabalho, proporcionando uma autoalimentação rápida e fácil de usar.
- Para fazer furos de grande diâmetro de forma limpa.
- Dispõem de um parafuso de alimentação central.
- Rosca helicoidal.
- As esporas de contorno definem com precisão o diâmetro do furo.

★★



D-74304



D-74407

Ø (mm)	Comp. (mm)	Unds.	Código	EAN	P.V.P. (€)
25	127	1	D-74304	0088381587341	12,70
28	127	1	D-74310	0088381587358	14,90
32	127	1	D-74326	0088381587365	16,50
35	127	1	D-74332	0088381587372	17,70
38	127	1	D-74348	0088381587389	20,00
45	127	1	D-74354	0088381587396	24,00
51	127	1	D-74360	0088381587402	26,00
54	127	1	D-74376	0088381587419	29,00
57	127	1	D-74382	0088381587426	34,00
65	127	1	D-74398	0088381587433	39,00
76	127	1	D-74407	0088381587440	58,00
92	127	1	D-74413	0088381587457	67,00
117	127	1	D-74429	0088381587464	86,00

### Pontas para brocas autoalimentadas

★★



Ø (mm)	Unds.	Código	EAN	P.V.P. (€)
25 - 65	1	D-74435	0088381587471	1,40
76 - 117	1	D-74441	0088381587488	1,40

### Extensões para brocas autoalimentadas

★★



Comp. (mm)	Unds.	Código	EAN	P.V.P. (€)
140	1	D-74457	0088381587495	11,00
305	1	D-74463	0088381587501	13,20
457	1	D-74479	0088381587518	16,00



**Brocas cilíndricas para metal**

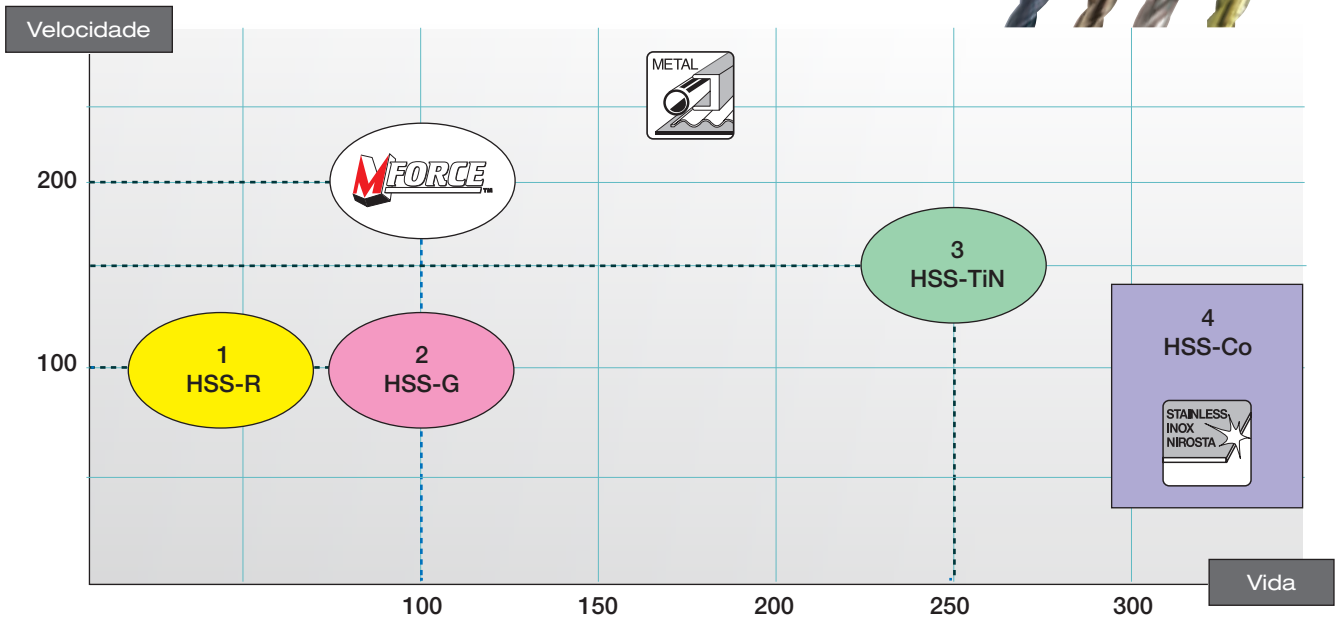
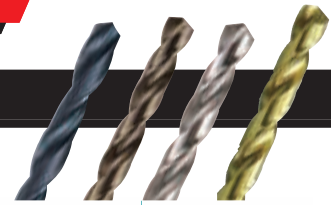

Descrição	A	B	C	D	E	
	Material	Processo de fabrico	Tipo de geometria	Acabamento	Inserção	
1	HSS-R	HSS	Laminada	118°	Preto	Cilíndrica
2	HSS-G	HSS	Retificada	118°	Brilhante	Cilíndrica
3	HSS-TiN	HSS	Retificada	135°	Titânio	Cilíndrica ou 1/4" hex.
4	HSS-Co	HSS-Co 5%	Retificada	135°	Cobalto	Cilíndrica
5	M-FORCE	HSS - M-FORCE	Retificada	M-FORCE	Titânio	Cilíndrica 3 faces

Descrição	Material						
	Madeira	Plástico	Metais não ferrosos	Chapa de aço	Ferro fundido	Aço	Aço inoxidável
1	◆	✓		◆	✓		
2	◆	✓	✓	✓	✓	✓	◆
3	◆	✓	✓	✓	✓	✓	◆
4			◆	◆	✓	✓	✓
5	◆	✓	✓	✓	✓	✓	◆

✓ : Recomendado    ◆ : Válido



Makita



**Brocas cilíndricas para metal**

**A Fabricada com**



Aço de corte rápido



Aço de corte rápido com 5 % de cobalto adicionado.

Para uma maior resistência à abrasão e ao calor. Ideal para perfuração de metais duros.

**B Tipo**

HSS-R

Laminadas



Fabricada em metal fundido. É o processo mais económico. Bisel nas bordas da espiral para uma melhor evacuação da apar.

HSS-G

Retificadas



Tanto a espiral como a borda são fabricadas a partir do mesmo bloco de metal, o que confere à broca uma qualidade superior.

Espiral chanfrada para um corte mais rápido e eficaz.

**C Geometria da ponta**

HSS-R e HSS-G

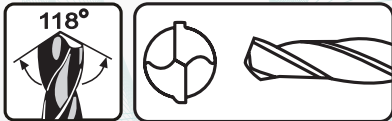

HSS-TIN e HSS-Co

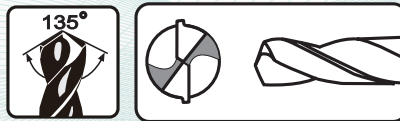

M-FORCE



O ângulo de 135° facilita o início da perfuração e evita que a broca escorregue.

Brocas com um ponto de autocentralização em forma de M que evita o seu deslocamento para uma perfuração mais precisa.

**D Acabamento**

Acabamento preto

Acabamento brilhante

Acabamento em titânio

Acabamento em cobalto



Durabilidade superior até 150% mais do que outras brocas.

Alta qualidade com 5% de cobalto.

**E Inserção**

Reta (cilíndrica)

Hexagonal 1/4"

Cilíndrica (3 faces)



Pode ser usada com porta-brocas de 1/4". Simplifica a trocas de brocas.

Três eixos planos na haste. Evita o deslizamento da broca.



**Brocas para metal HSS-R DIN338**



- Brocas indicadas para furar aço com resistência máxima de 900 N/mm<sup>2</sup>, ferro fundido, plásticos e metais não ferrosos.
- Risco mínimo de rutura para diâmetros pequenos graças à possibilidade de flexão do material.
- Espiral com duas saídas para uma evacuação eficaz do material em excesso.
- Brocas para corte em metal com um ângulo na ponta de 118°.
- Bisel nas bordas da espiral para uma melhor evacuação da aparã.

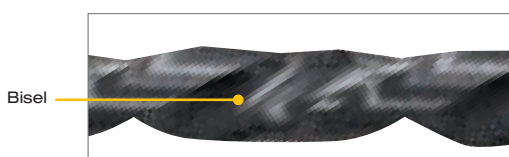

- Blister com duas unidades nas brocas com medidas compreendidas entre 1,5 - 4,0 mm.
- Brocas standard com uma relação qualidade-preço muito boa.

Ø (mm)	Comp. (mm)	Comp. útil (mm)	Unds.	Código	EAN	P.V.P. (€)
1,5	40	18	2	D-38299	0088381398787	1,25
2,0	49	24	2	D-38308	0088381398794	1,25
2,5	57	30	2	D-38314	0088381398800	1,20
3,0	61	33	2	D-38336	0088381398824	1,25
3,5	70	39	2	D-38358	0088381398848	1,25
4,0	75	43	2	D-38364	0088381398855	1,25
4,5	80	47	1	D-38386	0088381398879	0,90
5,0	86	52	1	D-38401	0088381398893	0,90
5,5	93	57	1	D-38417	0088381398909	0,90
6,0	93	57	1	D-38423	0088381398916	0,90
6,5	101	63	1	D-38439	0088381398923	1,25
7,0	109	69	1	D-38445	0088381398930	1,25
7,5	109	69	1	D-38451	0088381398947	1,25
8,0	117	75	1	D-38467	0088381398954	1,50
8,5	117	75	1	D-38473	0088381398961	1,50
9,0	125	81	1	D-38489	0088381398978	1,80
10,0	133	87	1	D-38495	0088381398985	2,15
11,0	142	94	1	D-38504	0088381398992	2,75
12,0	151	101	1	D-38510	0088381399005	3,30
13,0	151	101	1	D-38526	0088381399012	3,60

**Brocas para metal HSS-G DIN338**



- Brocas indicadas para furar aço com resistência máxima de 900 N/mm<sup>2</sup>, metais fundidos, plásticos duros e metais não ferrosos.
- Oferece uma perfuração mais rápida e uma vida útil superior.
- Espiral com duas saídas para uma evacuação eficaz do material em excesso.
- Fabrico em aço de excelente qualidade.
- Brocas para corte em metal com um ângulo na ponta de 135°.
- Espiral chanfrada para um corte mais rápido e eficaz.
- Brocas de boa qualidade para aplicações profissionais.

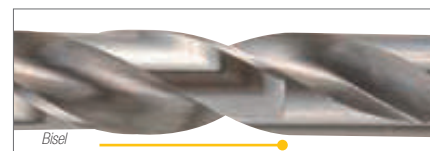

Ø (mm)	Comp. (mm)	Comp. útil (mm)	Unds.	Código	EAN	P.V.P. (€)
1,5	40	18	1	D-09656	0088381184922	0,90
2,0	49	24	1	D-09662	0088381184939	0,85
2,5	57	30	1	D-09678	0088381184946	0,90
3,0	61	33	1	D-09684	0088381184953	0,90
3,5	70	39	1	D-09690	0088381184960	1,20
4,0	75	43	1	D-09709	0088381184977	1,20
4,5	80	47	1	D-09715	0088381184984	1,30
5,0	86	52	1	D-09721	0088381184991	1,55
5,5	93	57	1	D-09737	0088381185004	1,75
6,0	93	57	1	D-09743	0088381185011	1,85
6,5	101	63	1	D-09759	0088381185028	2,05
7,0	109	69	1	D-09765	0088381185035	2,40
7,5	109	69	1	D-09771	0088381185042	2,65
8,0	117	75	1	D-09787	0088381185059	3,50

Ø (mm)	Comp. (mm)	Comp. útil (mm)	Unds.	Código	EAN	P.V.P. (€)
8,5	117	75	1	D-09793	0088381185066	3,20
9,0	125	81	1	D-09802	0088381185073	3,80
9,5	125	81	1	D-09818	0088381185080	4,10
10,0	133	87	1	D-09824	0088381185097	4,70
10,5	133	87	1	D-09830	0088381185103	6,10
11,0	142	94	1	D-09846	0088381185110	6,40
11,5	142	94	1	D-09852	0088381185127	7,00
12,0	151	101	1	D-09868	0088381185134	7,60
12,5	151	101	1	D-09874	0088381185141	8,10
13,0	151	101	1	D-09880	0088381185158	8,80
14	160	108	1	D-74893	0088381593786	20,00
15	169	114	1	D-74902	0088381593793	23,00
16	178	120	1	D-74918	0088381593809	26,00

**Brocas para metal HSS-TIN DIN338**



- Brocas indicadas para furar aço com resistência máxima de 900 N/mm<sup>2</sup>, metais fundidos, plásticos duros e metais não ferrosos.
- Brocas revestidas em nitrato de titânio para reduzir o atrito e prolongar a vida útil da broca.
- Brocas 40 % mais rápidas do que a nossa gama HSS-G.
- Duração 150% superior em relação à nossa gama HSS-G.
- Brocas para corte em metal com um ângulo na ponta de 135°, o que favorece a entrada no material e atinge uma maior velocidade de perfuração.
- Espiral chanfrada para um corte mais rápido e eficaz.
- Brocas de grande qualidade para aplicações profissionais que requerem maior velocidade.

Ø (mm)	Comp. (mm)	Comp. útil (mm)	Unds.	Código	EAN	P.V.P. (€)
1,5	40	18	2	D-64010	0088381530453	1,35
2	49	24	2	D-64026	0088381530460	1,35
2,5	57	30	2	D-64032	0088381530477	1,35
3	61	33	2	D-64048	0088381530484	1,35
3,5	70	39	2	D-64054	0088381530491	1,35
4	75	43	2	D-64060	0088381530507	1,35
4,5	80	47	1	D-64076	0088381530514	1,35
5	86	52	1	D-64082	0088381530521	1,35
5,5	93	57	1	D-64098	0088381530538	1,35
6	93	57	1	D-64107	0088381530545	1,35
6,5	101	63	1	D-64113	0088381530552	1,50
7	109	69	1	D-64129	0088381530569	1,75
7,5	109	69	1	D-64135	0088381530576	1,75
8	117	75	1	D-64141	0088381530583	2,00
8,5	117	75	1	D-64157	0088381530590	2,25
9	125	81	1	D-64163	0088381530606	2,25
9,5	125	81	1	D-64179	0088381530613	2,50
10	133	87	1	D-64185	0088381530620	2,75
10,5	133	87	1	D-64191	0088381530637	3,00
11	142	94	1	D-64200	0088381530644	3,25
11,5	142	94	1	D-64216	0088381530651	3,50
12	151	101	1	D-43228	0088381405706	4,00
12,5	151	101	1	D-64238	0088381530675	4,00
13	151	101	1	D-64244	0088381530682	4,25

**Brocas para metal HSS-TIN 1/4" hexagonal**



- Brocas indicadas para furar aço com resistência máxima de 1000 N/mm<sup>2</sup>, aços tratados, aços inoxidáveis e metais fundidos.
- Brocas de alta durabilidade, indicadas para trabalhos de precisão.
- Ideais para trabalhos em suportes para berbequins.
- Fabricadas em metal de alta qualidade com 5 % de cobalto adicionado.
- Brocas para corte em metais com um ângulo na ponta de 118°, que reduz o risco de deslocamento da broca durante a perfuração.
- Estas brocas são perfeitas para os trabalhos mais exigentes:
  - Aço inoxidável.
  - Trabalhos em todo o tipo de carroçarias de automóveis.
  - Cordões de soldadura.

Ø (mm)	Comp. (mm)	Comp. útil (mm)	Unds.	Código	EAN	P.V.P. (€)
3,0	81	33	1	D-14928	0088381185967	1,75
3,2	85	36	1	D-14934	0088381185974	2,05
4,0	95	43	1	D-14940	0088381185981	2,05
5,0	106	52	1	D-14962	0088381186001	2,35
6,0	113	57	1	D-14978	0088381186018	3,20
6,5	121	63	1	D-17778	0088381200622	4,40
8,0	117	75	1	D-15827	0088381186988	6,10
10,0	133	87	1	D-15833	0088381186995	9,30
12,0	151	101	1	D-15849	0088381187008	12,30
13,0	151	101	1	D-15855	0088381187015	15,70

**Broca rebitadora HSS**



Ø (mm)	Comp. (mm)	Comp. útil (mm)	Unds.	Código	EAN	P.V.P. (€)
3,3	50	20	10	B-56437	0088381490283	12,80

**Brocas para metal HSS-CO DIN338 ★★★★★**

- Brocas para furar aço com resistência máxima de 1000 N/mm<sup>2</sup>, aços tratados, aços inoxidáveis e metais fundidos.
- Alta durabilidade, indicadas para trabalhos de precisão. Ideais para trabalhos em suportes para berbequins.
- Fabricadas em metal de alta qualidade com 5 % de cobalto adicionado.



Ø (mm)	Comp. (mm)	Comp. útil (mm)	Unds.	Código	EAN	P.V.P. (€)
1,5	40	18	1	D-17289	0088381195942	1,45
2,0	49	24	1	D-17295	0088381195959	1,45
2,5	57	30	1	D-17304	0088381195966	1,50
3,0	61	33	1	D-17310	0088381195973	1,55
3,5	70	39	1	D-17332	0088381195997	1,55
4,0	75	43	1	D-17348	0088381196000	1,75
4,5	80	47	1	D-17354	0088381196017	2,05
5,0	86	52	1	D-17360	0088381196024	2,10
5,5	93	57	1	D-17376	0088381196031	2,60
6,0	93	57	1	D-17382	0088381196048	2,75
6,5	101	63	1	D-17398	0088381196055	3,20
7,0	109	69	1	D-17407	0088381196062	3,70
7,5	109	69	1	D-17413	0088381196079	5,00
8,0	117	75	1	D-17429	0088381196086	6,10
8,5	117	75	1	D-17435	0088381196093	6,40
9,0	125	81	1	D-17441	0088381196109	6,40
9,5	125	81	1	D-17457	0088381196116	8,60
10,0	133	87	1	D-17463	0088381196123	9,70
10,5	133	87	1	D-17479	0088381196130	10,80
11,0	142	94	1	D-17485	0088381196147	11,10
11,5	142	94	1	D-17491	0088381196154	13,90
12,0	151	101	1	D-17500	0088381196161	14,00
12,5	151	101	1	D-17516	0088381196178	16,60
13,0	151	101	1	D-17522	0088381196185	17,80

**Brocas metal para SDS-PLUS ★★★★★**



Ø (mm)	Comp. (mm)	Comp. útil (mm)	Unds.	Código	EAN	P.V.P. (€)
3	90	33	1	B-57401	0088381519014	3,50
3,5	100	39	1	B-57417	0088381519021	3,50
4	105	43	1	B-57423	0088381519038	4,10
4,5	110	47	1	B-57439	0088381519045	4,10
5	116	52	1	B-57445	0088381519052	5,00
5,5	123	5	1	B-57451	0088381519069	5,00
6	123	57	1	B-57467	0088381519076	5,00
6,5	131	63	1	B-57473	0088381519083	5,60

**Brocas madeira para SDS-PLUS ★★★**



Ø (mm)	Comp. (mm)	Comp. útil (mm)	Unds.	Código	EAN	P.V.P. (€)
4	105	43	1	B-57489	0088381519090	3,70
5	116	52	1	B-57495	0088381519106	3,80
6	123	57	1	B-57504	0088381519113	3,70
8	147	75	1	B-57510	0088381519120	4,40
10	163	87	1	B-57526	0088381519137	4,70

**Estojo brocas madeira metal SDS-PLUS**



Descrição	Unds.	Código	EAN	P.V.P. (€)
Jogo de brocas SDS-PLUS madeira e metal	1	B-57532	0088381519144	14,80

**Brocas cónicas**

**A Tipo**

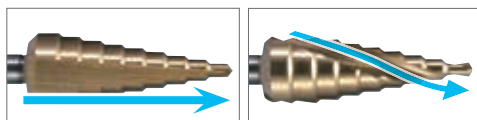

**B Superfície**



**C Inserção**



Ø (mm)	Flauta	Tipo	Unds.	Código	EAN	P.V.P. (€)
3-14	Reta	HSS	1	D-40048	0088381400244	19,10
4-20	Reta	HSS	1	D-40054	0088381400251	29,00
16-30,5	Reta	HSS	1	D-40060	0088381400268	54,00
24-40	Reta	HSS	1	D-40076	0088381400275	96,00

**Brocas cónicas escalonadas**



Ø (mm)	Flauta	Tipo	Unds.	Código	EAN	P.V.P. (€)
4-32	Reta	HSS	1	D-40107	0088381400305	73,00
4-32	Reta	HSS-TIN	1	D-40135	0088381400336	83,00
4-32	Espiral	HSS	1	D-40163	0088381400367	78,00
4-32	Espiral	HSS-TIN	1	D-40191	0088381400398	95,00



**Brocas para berbequim magnético HB500 e HB350**

- Espiral para uma boa evacuação de rebarbas. Ponta centralizadora que ajuda na extração do material após a perfuração.
- Inserção universal de 19 mm.













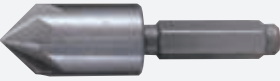



Ø (mm)	Comp. (mm)	Comp. Útil (mm)	Unds.	Código	EAN	P.V.P. (€)
12	30	19	1	12S	-	24,00
12	50	19	1	12L	-	32,00
13	30	19	1	13S	-	24,00
13	50	19	1	13L	-	33,00
14	30	19	1	14S	-	24,00
14	50	19	1	14L	-	34,00
15	30	19	1	15S	-	25,00
15	50	19	1	15L	-	35,00
16	30	19	1	16S	-	26,00
16	50	19	1	16L	-	36,00
17	30	19	1	17S	-	26,00
17	50	19	1	17L	-	37,00
18	30	19	1	18S	-	26,00
18	50	19	1	18L	-	40,00
19	30	19	1	19S	-	27,00
19	50	19	1	19L	-	42,00
20	30	19	1	20S	-	29,00
20	50	19	1	20L	-	44,00
21	30	19	1	21S	-	30,00
21	50	19	1	21L	-	47,00
22	30	19	1	22S	-	31,00
22	50	19	1	22L	-	47,00
23	30	19	1	23S	-	32,00
23	50	19	1	23L	-	49,00
24	30	19	1	24S	-	33,00
24	50	19	1	24L	-	51,00
25	30	19	1	25S	-	37,00
25	50	19	1	25L	-	54,00
26	30	19	1	26S	-	39,00
26	50	19	1	26L	-	57,00
27	30	19	1	27S	-	40,00
27	50	19	1	27L	-	60,00
28	30	19	1	28S	-	45,00
28	50	19	1	28L	-	61,00
29	30	19	1	29S	-	46,00
29	50	19	1	29L	-	64,00
30	30	19	1	30S	-	47,00
30	50	19	1	30L	-	67,00
31	30	19	1	31S	-	48,00
31	50	19	1	31L	-	70,00

Ø (mm)	Comp. (mm)	Comp. útil (mm)	Unds.	Código	EAN	P.V.P. (€)	
32	30	19	1	32S	-	49,00	
32	50	19	1	32L	-	73,00	
33	30	19	1	33S	-	50,00	
33	50	19	1	33L	-	78,00	
34	30	19	1	34S	-	52,00	
34	50	19	1	34L	-	79,00	
35	30	19	1	35S	-	57,00	
35	50	19	1	35L	-	82,00	
36	30	19	1	36S	-	56,00	
36	50	19	1	36L	-	86,00	
37	30	19	1	37S	-	58,00	
37	50	19	1	37L	-	89,00	
38	30	19	1	38S	-	62,00	
38	50	19	1	38L	-	90,00	
39	30	19	1	39S	-	63,00	
39	50	19	1	39L	-	100,00	
40	30	19	1	40S	-	72,00	
40	50	19	1	40L	-	105,00	
41	30	19	1	41S	-	73,00	
41	50	19	1	41L	-	109,00	
42	30	19	1	42S	-	74,00	
42	50	19	1	42L	-	111,00	
43	30	19	1	43S	-	76,00	
43	50	19	1	43L	-	114,00	
44	30	19	1	44S	-	78,00	
44	50	19	1	44L	-	119,00	
45	30	19	1	45S	-	79,00	
45	50	19	1	45L	-	133,00	
46	30	19	1	46S	-	88,00	
46	50	19	1	46L	-	137,00	
47	30	19	1	47S	-	90,00	
47	50	19	1	47L	-	146,00	
48	30	19	1	48S	-	91,00	
48	50	19	1	48L	-	151,00	
49	30	19	1	49S	-	94,00	
49	50	19	1	49L	-	153,00	
50	30	19	1	50S	-	96,00	
50	50	19	1	50L	-	155,00	
				Broca centradora 30mm	PILOTS	-	7,70
				Broca centradora 50mm	PILOTL	-	9,60



**Escareadores multimaterial**

✓ : Recomendado

Descrição	A	B	C	Material					
	Fabricado com	Tipo	Inserção	Madeira	Plástico	Metais não ferrosos	Ferro fundido	Aço	Aço inoxidável
<b>7 fios</b> 	 Aço		1/4" Hex	✓	✓	✓	✓		
<b>3 fios</b> 	 HSS		1/4" Hex (Forma-C)	✓	✓	✓	✓	✓	
<b>5 fios</b> 	 HSS		Inserção cilíndrica	✓	✓	✓	✓	✓	
<b>3 fios</b> 	 HSS		Inserção cilíndrica	✓	✓	✓	✓	✓	
	 HSS-Co		Inserção cilíndrica		✓	✓	✓	✓	✓

**A Fabricado em Aço**

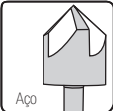

**HSS**



Aço de corte rápido com 5 % de cobalto. Proporciona maior dureza e resistência à abrasão. Ideal para metais duros.

**HSS-Co**

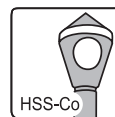

**B Tipo**

Escareador cônico superficial



Escareador cônico superficial. Adequado para lâminas finas.



Escareador cônico com haste longa. Perfeito para escareamentos de difícil acesso.



**C Inserção Cilíndrica**



**1/4" Hexagonal**





## Escareadores multimaterial

- Gama de escareadores multimaterial, adequados para metal, metais não ferrosos e também para madeira. O escareamento é um processo intermédio entre a perfuração e o aparafusamento. É utilizado para o desenvolvimento de montagens através da incorporação da cabeça do parafuso utilizado no material perfurado.
- Uma vez perfurado o material, seleciona-se o escareador mais adequado para o parafuso a aparafusar.
- Uma vez realizado o escareamento, podemos preceder ao aparafusamento até que a cabeça do parafuso esteja completamente alinhada com a superfície do material.
- Outro dos trabalhos que podemos realizar com os escareadores é limpar a rebarba interna que permanece num tubo após o corte.

### Escareador cónico de aço com haste 1/4" hexagonal

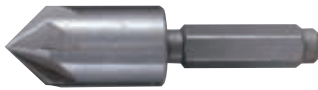
Metal, metais não ferrosos e madeira.



★★

Ø (mm)	Escareamento	Comprimento (mm)	Fios	Tipo	Unds.	Código	EAN	P.V.P. (€)
13	90°	50	7	Aço	1	D-37306	0088381376105	4,90

### Escareador cónico de HSS com haste 1/4" hexagonal

Metal, metais não ferrosos e madeira.



★★★

Ø (mm)	Escareamento	Comprimento (mm)	Fios	Tipo	Unds.	Código	EAN	P.V.P. (€)
6,3	M3	31	3	HSS	1	D-37312	0088381376112	6,40
8,3	M4	31	3	HSS	1	D-39045	-	7,60
10,4	M5	34	3	HSS	1	D-37334	0088381376136	8,80
12,4	M6	35	3	HSS	1	D-37340	0088381376143	9,30
16,5	M8	40	3	HSS	1	D-37356	0088381376150	14,00
20,5	M10	41	3	HSS	1	D-37362	0088381376167	16,90

### Escareador cónico de HSS com haste cilíndrica 6mm

Metal, metais não ferrosos e madeira.



★★★

Ø (mm)	Escareamento	Comprimento (mm)	Fios	Tipo	Unds.	Código	EAN	P.V.P. (€)
6	M3	48	5	HSS	1	D-37378	0088381376174	6,40
8	M4	48	5	HSS	1	D-39045	-	7,00
10	M5	40	5	HSS	1	D-37390	0088381376198	8,70
12	M6	40	5	HSS	1	D-37409	0088381376204	9,90
16	M8	43	5	HSS	1	D-37415	0088381376211	11,70
20	M10	45	5	HSS	1	D-37421	0088381376228	15,70

### Escareador cónico de HSS com haste cilíndrica 5-6-8-10mm

Metal, metais não ferrosos e madeira.



★★★

Ø (mm)	Escareamento	Comprimento (mm)	Fios	Tipo	Unds.	Código	EAN	P.V.P. (€)
6,3	M3	45	3	HSS	1	D-37437	0088381376235	6,40
8,3	M4	50	3	HSS	1	D-37443	0088381376242	8,10
10,4	M5	50	3	HSS	1	D-37459	0088381376259	9,40
12,4	M6	56	3	HSS	1	D-37465	0088381376266	10,00
16,5	M8	60	3	HSS	1	D-37471	0088381376273	13,40
20,5	M10	63	3	HSS	1	D-37487	0088381376280	17,50
25	M12	67	3	HSS	1	D-37493	0088381376297	22,00

### Escareador com orifício oblíquo HSS-Co 5% com haste cilíndrica 6-8-10-12mm



★★★★

Ø (mm)	Escareamento	Comprimento (mm)	Fios	Tipo	Unds.	Código	EAN	P.V.P. (€)
2-5	90°	45	Orifício	HSS-Co	1	D-37502	0088381376303	11,70
5-10	90°	48	Orifício	HSS-Co	1	D-37518	0088381376310	19,10
10-15	90°	65	Orifício	HSS-Co	1	D-37524	0088381376327	29,00
15-20	90°	85	Orifício	HSS-Co	1	D-37530	0088381376334	51,00



**Estojo de brocas para metal HSS-Co**



★★★★★

D-67561

D-75758

Ø (mm)	Conteúdo	Unds.	Código	EAN	P.V.P. (€)
de 1 a 10mm	19 peças	1	D-67561	0088381549196	62,00
de 2 a 8mm	6 peças	1	D-75758	0088381597241	15,50

**Estojo de brocas para metal M-Force**



★★★★★

Ø (mm)	Conteúdo	Unds.	Código	EAN	P.V.P. (€)
de 1 a 10mm	19 peças	1	D-67583	0088381549219	66,00

**Estojo de brocas para metal HSS-G**



★★★

D-67549

D-75742

Ø (mm)	Conteúdo	Unds.	Código	EAN	P.V.P. (€)
de 1 a 10mm	19 peças	1	D-67549	0088381549172	49,00
de 2 a 8mm	6 peças	1	D-75742	0088381597234	10,70

**Estojo de brocas para metal HSS-TiN**



★★

Ø (mm)	Conteúdo	Unds.	Código	EAN	P.V.P. (€)
de 1 a 10mm	19 peças	1	D-67527	0088381548243	25,00

**Estojo de brocas para metal HSS-TiN**



★★

Ø (mm)	Conteúdo	Unds.	Código	EAN	P.V.P. (€)
de 2 a 8mm	6 peças	1	D-72833	0088381577342	6,40

**Estojo de brocas para metal HSS-R**



★

Ø (mm)	Conteúdo	Unds.	Código	EAN	P.V.P. (€)
de 1 a 10mm	19 peças	1	D-54081	0088381450201	19,40

**Estojo de brocas para tijolo**



★★

D-72877



★★

D-73483

Ø (mm)	Conteúdo	Unds.	Código	EAN	P.V.P. (€)
4, 5, 6, 8 e 10 mm	5 peças	1	D-72877	0088381577380	5,80
4 - 5 - 5,5 - 6 - 6,5 - 7 - 8	12 peças	1	D-73483	0088381584845	13,80





**Estojo de brocas para metal, tijolo e madeira**



★★★

Conteúdo	Total	Unds.	Código	EAN	P.V.P. (€)
6 metal	18 peças	1	D-46202	0088381411776	23,00
6 madeira					
6 tijolo					



★★★

Conteúdo	Total	Unds.	Código	EAN	P.V.P. (€)
3 metal	9 peças	1	D-71962	0088381566490	8,50
3 madeira					
3 tijolo					

**Estojo de brocas para madeira**



★★★

Ø (mm)	Conteúdo	Unds.	Código	EAN	P.V.P. (€)
de 4 a 10mm	5 peças	1	D-72861	0088381577373	5,30

**Jogo de brocas de pala para madeira**



★★★

Ø (mm)	Conteúdo	Unds.	Código	EAN	P.V.P. (€)
de 12 a 32mm	8 peças	1	E-08698	0088381579605	22,00

**Estojo de brocas 1/4" hexagonal**

- Madeira
- Metal



★★★

Conteúdo	Total	Unds.	Código	EAN	P.V.P. (€)
3 metal	5 peças	1	D-20769	0088381287760	12,90
2 madeira					

- Madeira
- Metal
- Tijolo



★★★

Conteúdo	Total	Unds.	Código	EAN	P.V.P. (€)
2 metal	5 peças	1	D-23759	0088381312844	10,20
2 madeira					
1 tijolo					

**Estojo de brocas Omnibohrer Multimaterial**



★★★

- Brocas para furar todos os tipos de materiais leves como tijolo, madeira, alumínio, plástico e betão.
- Adequadas para brocas de 2 modos: Berbequim e berbequim + percussão.
- As brocas Omnibohrer da Makita são mais duradouras do que as brocas multimaterial dos seus concorrentes.

Material	Betão	Azulejo	Tijolo	Ardósia	Calcário	Madeira	Madeira Plástico	Plástico	Alumínio	Metal
Símbolo										
Modo										
Adequado	○	○	○	○	○	○	○	○	△	×

○ Excelente      △ Bom      × Não recomendado

Ø (mm)	Comp. (mm)	Unds.	Código	EAN	P.V.P. (€)
5	85	1	D-30477	0088381353335	7,10
6	100	1			
8	110	1			
10	150	1			
12	150	1			



**Estojo de pontas e brocas cilíndricas**

★★★



Conteúdo	Unds	Código	EAN	P.V.P. (€)
29 peças	1	E-07054	0088381571258	26,00

**Estojo de pontas e brocas SDS-PLUS**

★★★



Conteúdo	Unds	Código	EAN	P.V.P. (€)
18 peças	1	E-07026	0088381571227	31,00

**Jogo de pontas, caixas + escareador**

★★



Conteúdo	Unds	Código	EAN	P.V.P. (€)
Pontas, escareadores, porta-brocas magnético, chaves de caixa...	1	D-73461	0088381584821	32,00

**Jogo de pontas + escareador**

★★



Conteúdo	Unds.	Código	EAN	P.V.P. (€)
Pontas, escareadores e porta-brocas magnético...	1	D-73477	0088381584838	30,00

**Estojo de brocas e pontas**

★★★



- 4 brocas de alvenaria: 4 x 75mm, 5 x 85mm, 6 x 100mm, 8 x 120mm.
- 4 brocas para metal: 3 x 65mm, 4 x 75mm, 5 x 85mm, 6 x 95mm.
- 8 pontas de 25mm: PH2, PZ2, PH3, PZ3, Plana de 0.8 x 5.5 Plana de 1,2 x 6.5 T20, T25.
- Porta-pontas magnético.

Conteúdo	Unds.	Código	EAN	P.V.P. (€)
17 peças	1	D-40200	0088381401869	16,00

**Novo**



- 7 pontas 1/4" hex: PH1, PH2, PH3, PZ1, PZ2, PZ3, SL5.
- Porta-brocas de 60mm.
- Brocas HSS-Tin (5, 6 e 8mm).
- Brocas de madeira (5, 6 e 8mm).
- Brocas de betão (5, 6 e 8mm).

Conteúdo	Unds.	Código	EAN	P.V.P. (€)
17 peças	1	D-74887	0088381592123	17,10

★★★



- Pontas 25 mm PH, PZ e T.
- Pontas 50 mm PH, PZ e T.
- Brocas pala 10 - 25 mm.
- Brocas HSS-R 1,5 - 6 mm.

Conteúdo	Unds.	Código	EAN	P.V.P. (€)
71 peças	1	B-50295	0088381463317	41,00

**Jogo de brocas com escareador 4 peças**

★★

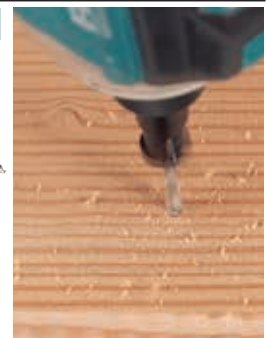
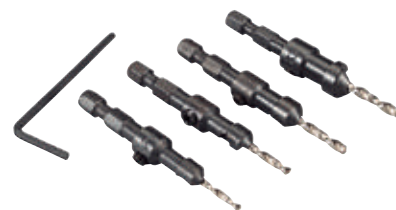

Ø (mm)	Unds.	Código	EAN	P.V.P. (€)
6 - 8 - 10 - 12	1	D-73455	0088381584722	9,40

**Malas de acessórios**



★★★

- 30 pontas 25 mm PH, PZ, T, SL e H.
- 20 Pontas 50 mm PH, PZ, T, SL e H.
- Porta-brocas magnético.
- 13 chaves de caixa.
- Chave sextavada.
- Punção central.
- Escareador.
- Brocas madeira 3,4,5, 5.5, 6, 6.5.
- Adaptador de coroa.
- Brocas para metal HSS- TiN: 3, 4, 5, 5.5, 6, 6.5mm.
- Brocas para alvenaria: 3, 4, 5, 5.5, 6, 6.5mm.
- Brocas planas hexagonais: 12, 16, 19mm.
- 4 brocas de coroa: 32, 38, 40, 54mm.
- Nível.
- Fita métrica 3 m.
- Medidor de diâmetro.
- Ponta para gesso.

Conteúdo	Unds.	Tipo	Código	EAN	P.V.P. (€)
102 peças	1	***	E-10730	0088381580557	58,00



★★★

- Brocas HSS-TiN: 1, 1.5, 2, 2.5, 3, 3.5, 4, 4.5, 5, 5.5, 6, 6.5 e 7 mm
- Brocas para alvenaria: 3, 4, 5, 5.5, 6, 6.5, 7, 8, 9 e 10mm
- Brocas para madeira: 3, 4, 5, 6, 8 e 10 mm.
- Pontas 25 mm: PH - PZ - SL, Hex e T.
- Pontas 50 mm: PH -PZ - SL - Hex e T.
- Chaves de caixa.
- Ponta magnética para pladur 30 mm.
- Porta-pontas magnético 60 mm.
- Escareador 36 mm.
- Batentes de profundidade: 3 - 5 e 8mm
- Chave Allen 2,5 mm.
- Calibre para brocas.

Conteúdo	Unds.	Tipo	Código	EAN	P.V.P. (€)
102 peças	1	***	B-68432	0088381546072	47,00



★★★

- Brocas de metal 1 - 1,5 - 2 - 2,5 - 3 - 3,2 - 3,5 - 4 - 4,5 - 5 - 5,5 - 6 - 6,5 - 7 - 7,5 - 8 - 9 e 10 mm.
- Brocas para alvenaria: 3 - 4 - 4,5 - 5 - 5,5 - 6 - 6,5 - 7 - 8 e 10 mm.
- Brocas para madeira: 3 - 4 - 5 - 6 - 7 - 8 - 9 e 10 mm.
- Brocas de pala para madeira: 10 - 12 - 16 - 18 - 20 - 22 - 25 - 12 e 14 mm.
- Pontas 25 mm: PH - PZ - SL - Hex - T e SQ.
- Pontas 50 mm: PH - PZ - SL e Hex.
- Chaves de caixa.
- Escareador 12,7 mm.
- Porta-pontas magnético 60 mm.
- Batentes de profundidade: 3 - 5 - 6 - 8 e 10 mm.
- Chave Allen 2,5 mm.
- Calibre para brocas.
- Brocas de coroa com adaptador (mm): 32 - 38 - 44 - 54.
- Régua Makita 3mx13mm.
- Nível.
- Chave de fendas magnético manual e chave de fendas manual.
- Punções.
- Lápis de carpinteiro.
- Porta-pontas flexível.

Conteúdo	Unds	Tipo	Código	EAN	P.V.P. (€)
212 peças	1	***	E-06270	0088381568746	104,00



★★★

- Brocas de metal HSS-R: 1 - 1,5 - 2 - 2,5 - 3 - 3,2 - 3,5 - 4 - 4,5 - 5 - 5,5 - 6 - 7 - 7,5 e 8 mm
- Brocas para madeira: 3 - 4 - 5 - 6 - 7 - 8 - 9 e 10 mm.
- Brocas de pala para madeira: 12 - 16 - 20 - 22 - 25 - 12 e 14mm.
- Brocas para alvenaria: 3 - 4 - 4,5 - 5 - 6 - 7 - 8 e 10mm.
- Escareador 36.
- Pontas 25 mm: PH - PZ - SL - T e H3
- Pontas 50 mm: PH e PZ.
- Adaptador de troca de inserção 1/4" 3/8".
- Porta-pontas magnético 60 - 80mm.
- Chaves de caixa.
- Brocas de coroa.
- Adaptador de brocas de coroa 90mm.
- Calibre para brocas.
- Chave Allen 2,5 mm.
- Batentes de profundidade: 3 - 5 - 6 - 8 e 10 mm.
- Set de Chaves Allen (mm).
- Set de Chaves Allen (polegadas).
- Régua Makita 3mx13mm.
- Cortador.
- Nível.
- Chave de fendas manual.
- Chave inglesa.
- Lápis de carpinteiro 150 mm.
- Ponta magnética para paredes divisórias secas.

Conteúdo	Unds	Tipo	Código	EAN	P.V.P. (€)
216 peças	1	***	E-11689	0088381585019	121,00



**Mala de acessórios**



★★★

- Pontas 25 mm PH, PZ, T, SL e H.
- Estojo 25 pontas 25 mm PZ2.
- Pontas 60 mm PH, PZ e T.
- Porta-pontas 60mm 1/4".
- Escareador 1/4".
- Chave de caixa 1/4 Hex. 6, 8 e 10 mm.
- Brocas madeira 3, 4, 5, 6 e 8 mm.
- Brocas widia 6, 7 e 8 mm.
- Brocas pala 12 e 16 mm.
- Brocas coroa Bi-metal 32 e 38 mm.
- Adaptador coroa.
- Brocas HSS 2, 3, 4, 5 e 8 mm.

Conteúdo	Unds.	Código	EAN	P.V.P. (€)
100 peças	1	B-54520	0088381477802	57,00



- Pontas de 25mm. PZ0(1ud), PZ1(2ud), PZ2(6ud), PZ3(2ud), PH1(1ud), PH2(1ud), PH3(1ud), T15(1ud), T20(1ud), HEX3(1ud), HEX4(1ud), HEX5(1ud), HEX6(1ud), SL0,5x3(1ud), SL0,8x4(3ud), SL0,8x5(1ud), SL1x5,5(2ud), SL1x6(1ud), SL1,2x6,5(2ud), SL1,2x7(1ud).
- Porta-pontas magnético 1/4"Hex, 30mm.
- Ponta magnética para pladur, 30mm.
- Escareador 36mm.
- Chaves de caixa 1/4"Hex 38mm, 5, 6, 7, 8, 9, 10, 11, 13mm de diâmetro.
- 6 Brocas para madeira. 3x60, 4x75, 5x85, 6x92, 7x100, 8x114mm.
- 7 Brocas para metal HSS-TIN. 2x49, 3x61(2ud), 3,2x65, 4x75, 4,5x80, 5x86mm.
- 5 Brocas para alvenaria. 5x85, 5,5x85, 6x100, 7x100, 8x120mm.

Conteúdo	Unds.	Código	EAN	P.V.P. (€)
60 peças	1	E-11829	0088381587525	29,00

**Mala de acessórios Maccess**

**MACCESS**

- Estojo de 34 peças:
- Brocas de metal HSS-R.
- Chaves de caixa.
- Porta-pontas magnético
- Brocas para alvenaria.
- Escareador.
- Brocas para madeira.
- Pontas de várias medidas.

★★★★

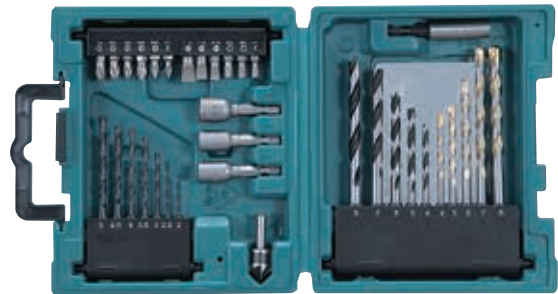
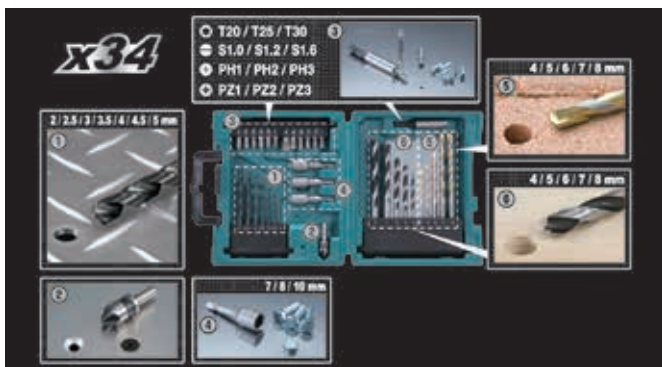

Conteúdo	Unds.	Código	EAN	P.V.P. (€)
34 peças	1	D-36980	0088381374248	29,00



★★★★

- Estojo de 71 peças:
- Brocas de metal HSS-Tin.
- Brocas para alvenaria.
- Brocas para madeira.
- Brocas de pala.
- Escareador.
- Fita métrica (3M).
- Lâmina.
- Porta-pontas magnético.
- Pontas de várias medidas.
- Chaves de caixa.
- Chave de fendas.
- Pontas de várias medidas.



Conteúdo	Unds.	Código	EAN	P.V.P. (€)
71 peças	1	D-33691	0088381360586	73,00



Mala de acessórios Maccess



- Caixa de 104 peças:
- Brocas de metal HSS-Tin.
- Brocas para alvenaria.
- Brocas para madeira.
- Brocas de pala.
- Escareador.
- Fita métrica 3 m.
- Cortador.
- Porta-pontas magnético.
- Chaves de caixa.
- Chave de fendas.
- Batentes de profundidade.
- Nível.
- Pontas de várias medidas.



Conteúdo	Unds.	Código	EAN	P.V.P. (€)
104 peças	1	D-31778	0088381358590	95,00

**x104**

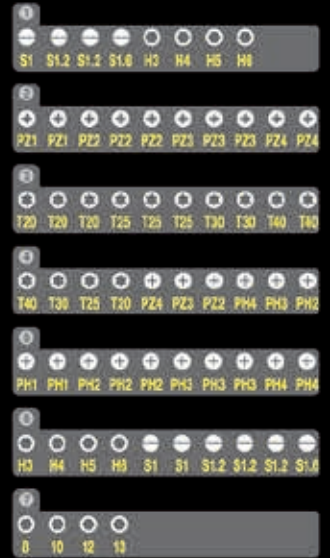
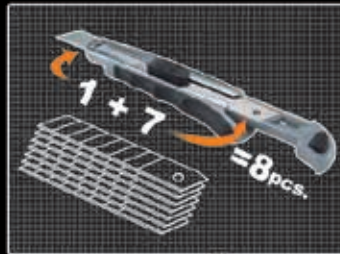

**Mala de acessórios Maccess**

★★★★



- Estojo de 200 peças:
- Brocas de metal HSS-Tin.
- Brocas para alvenaria.
- Brocas para madeira.
- Brocas de pala.
- Escareador.
- Fita métrica (5M).
- Lâmina.
- Porta-pontas magnético.
- Chaves de caixa.
- Chave de fendas.
- Batentes de profundidade.
- Nivel.
- Extensores de aparafusamento.
- Chave inglesa.
- Brocas de coroa.
- Alicates de ponta.
- Alicates de corte.
- Lanterna.
- Pontas de várias medidas.



Conteúdo	Unds.	Código	EAN	P.V.P. (€)
200 peças	1	D-37194	0088381375399	163,00

X200

300 mm

3/5/8/10 mm

M6

90°

8/15/20 mm

5/5.5/6/7/8/9/10/11/12/13 mm

1/1.5/2/2.5/3/3.2/3.5/4/4.5/5/5.5/6/6.5/7/8/10 mm

5/6/7/8/9/10/11/13 mm

32/38/45/54/68 mm

LED

No Incluída

1 + 7

26 mm

X10

X10

X10

P10 P11 P12 P13 P14 P15 P16 P17 P18 P19 P20 P21 P22 P23

S0.5 S0.8 S1.2 S1.6 S2.0 S2.4 S2.8 S3.2 S3.6 S4.0

P24 P25 P26 P27 P28 P29 P30 P31 P32 P33 P34

T10 T11 T12 T13 T14 T15 T16 T17 T18 T19 T20 T21 T22 T23 T24

S0.8 S1.2 S1.6 S2.0 S2.4 S2.8 S3.2 S3.6 S4.0

P25 P26 P27 P28 P29 P30 P31 P32 P33 P34

T25 T26 T27 T28 T29 T30 T31 T32 T33 T34 T35 T36 T37 T38 T39

P35 P36 P37 P38 P39 P40 P41 P42 P43 P44

110



**Mala de acessórios Makpac**

**Set de acessórios Makpac B-69478:**  
Makpac tipo 1.

- Brocas SDS-PLUS para metal HSS-TIN:
  - 3x 90, 3.5x 100, 4x 105, 4.5x 110, 5x 116, 5.5x 123, 6x 123, 6.5x 131 mm.
- Brocas SDS-PLUS:
  - 6x 160, 7x 160, 8x 160, 10x 160, 12x 160 mm.
- Brocas para madeira:
  - 4x 105, 5x 116, 6x 123, 8x 147, 10x 163, 12x 160 mm.
- Pontas:
  - 2x PH0, 2x PH1, 3x PH, 3x PH3.
  - 2x PZ0, 2x PZ1, 2x PZ3, 2x PZ3.
  - 2x SL4, 2x SL5, 2x SL5.5, 2xSL6.5.
  - H3, H4, H5, H6
  - T10, T15, 2xT20, 2x T25, T30, T40.
- Chaves de caixa:
  - 8, 10, 12, 13 mm.
- Escareador.
- Porta-pontas 80 mm SDS-PLUS.
- Fita métrica 3M.



★★★★

Conteúdo	Unds.	Código	EAN	P.V.P. (€)
65 peças	1	B-69478	0088381548731	118,00

**Set de acessórios Makpac B-49638:**  
Makpac tipo 1.

- Estojo de pontas 25 mm.
  - Porta-pontas 60 mm
  - PH0, PH1, 2x PH2, PH3.
  - PZ0, PZ1, 2x PZ2, PZ3.
  - SL4, SL4.5, SL5.5, SL6.5.
  - T10, 2x T15, 2xT20, 2x T25, T27, 2x T30, T40.
  - T10H, T15H, T25H, T27H, T30H, T40H.
  - H3, H4, H5, H6.
- Pack de pontas PH2/PZ2 50 mm:
  - 5x PH2.
  - 5x PZ2.
- Porta-pontas magnético 1/4 Hex tipo "clique".
- Chaves de caixa: 6/8/10/12/13 mm.
- Brocas de pala: 16/20 mm.
- Brocas de madeira: 3/4/5/6/8 mm.
- Brocas de metal HSS-G: 3/4/5/6/8 mm.
- Brocas alvenaria HM: 5/6/8/10 mm.
- Bandeja para colocação de acessórios.



★★★★

Conteúdo	Unds.	Código	EAN	P.V.P. (€)
69 peças	1	B-49638	0088381459631	118,00

**Set de acessórios Makpac B-49725:**  
Makpac tipo 1.

- 2 Estojos de pontas 25 mm.
  - Porta-pontas 60 mm:
    - PH0, PH1, 2x PH2 e PH3.
    - PZ0, PZ1, 2x PZ2 e PZ3.
    - SL4, SL4.5, SL5.5 e SL6.5.
    - H3, H4, H5 e H6.
    - T10, 2x T15, 2x T20, 2x T25, T27, 2x T30 e T40.
    - T10H, T15H, T25H, T27H, T30H e T40H.
  - Cabo porta-pontas.
- Estojo de brocas D-46202.
  - Brocas de metal HSS-G: 3/4/5/6/8/10 mm.
  - Brocas de madeira: 3/4/5/6/8/10 mm.
  - Brocas de alvenaria HMCT: 3/4/5/6/8/10 mm.
- Fita métrica.
- Cortador (com lâminas sobressalentes).
- Chave de fendas de roquete.



★★★★

Conteúdo	Unds.	Código	EAN	P.V.P. (€)
96 peças	1	B-49725	0088381460965	149,00

**Set de acessórios Makpac B-49884:**  
Makpac tipo 1.

- Estojo de brocas D-46202.
  - Brocas de metal HSS-G: 3/4/5/6/8/10 mm.
  - Brocas de madeira: 3/4/5/6/8/10 mm.
  - Brocas de alvenaria HMCT: 3/4/5/6/8/10 mm.
- Estojo de brocas, pontas e caixas.
  - Brocas metal HSS-G: 3/4/5/6/8/10 mm.
  - Pontas 25 mm:
    - 2x PH1, 2x PH2 e PH3.
    - 2x PZ1, 2x PZ2 e PZ3.
  - T10, 2x T15, 2x T20, 2xT25, 2x T30 e T40.
  - SL4,5, 2x SL5,5 e 2x SL6,5.
  - H2, H2,5, H3, H4, 2x H5 e 2x H6.
  - Chaves de caixa 1/4 Hex: 4/5/6/8/10 mm.
  - Porta-pontas magnético 1/4 Hex tipo "clique".
- Estojo de pontas e chaves de caixa:
  - Pontas 25 mm:
    - 2x PH1, 2x PH2 e PH3.
    - 2x PZ1, 2x PZ2 e PZ3.
  - T10, 2x T15, 2x T20, 2xT25, 2x T30 e T40.
  - 2x SL4,5, 2x SL5,5 e 2x SL6,5.
  - H2, H2,5, H3, H4, 2x H5 e 2x H6.
  - Chaves de caixa 1/4 Hex: 4/5/6/8/10 mm.
  - Porta-pontas magnético 1/4 Hex tipo "clique".
  - Destornillador de carraca.
- Fita métrica 3 m.
- Cortador (com lâminas sobressalentes).
- Lanterna LED (sem pilhas).

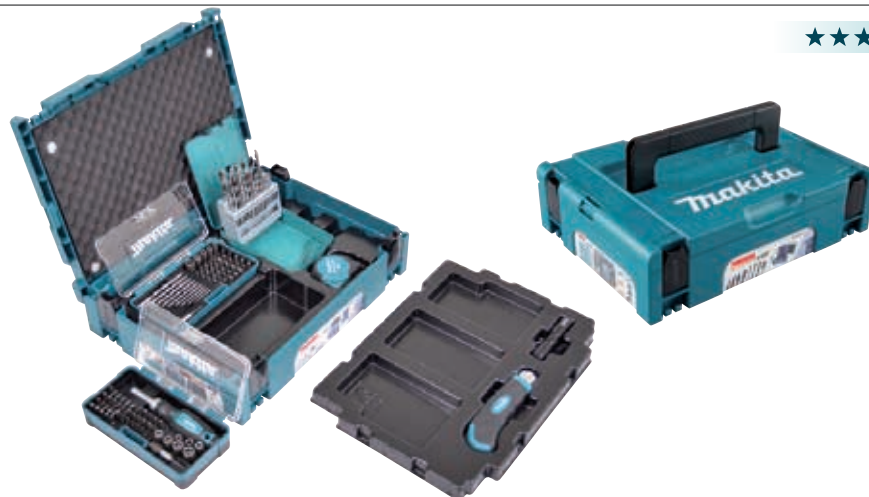











★★★★

Conteúdo	Unds.	Código	EAN	P.V.P. (€)
116 peças	1	B-49884	0088381462037	159,00



**Brocas de coroa**

Aplicação	Alumínio 	Aço inoxidável 	PVC 	Aço 	Metais não ferrosos 	Madeira 	Epoxy 
✓ Recomendado • Válido							
<b>Ezychange</b> 	✓	•	•	✓	✓	•	
BIM 	•		✓	✓	•	✓	
TCT 	•	✓	✓	✓	•		✓
Conselhos	Usar óleo de corte	Baixas Rpm usar com óleo de corte		Usar óleo de corte	Usar óleo de corte		

**Brocas de coroa Bi-Metálicas**



Aplicação:  
Para aço, ferro, metal, madeira ou plástico.

Ø (mm)	Comp. (mm)	Comp. útil (mm)	Unds.	Código	EAN	P.V.P. (€)
14	50	38	1	D-35368	0088381369015	3,60
16	50	38	1	D-16994	0088381194792	3,70
17	50	38	1	D-35374	0088381369022	4,30
19	50	38	1	D-17005	0088381194808	4,20
20	50	38	1	D-17251	0088381195805	4,50
21	50	38	1	D-35380	0088381369039	4,80
22	50	38	1	D-17011	0088381194815	4,80
24	50	38	1	D-17027	0088381194822	5,50
25	50	38	1	D-17033	0088381194839	5,50
27	50	38	1	D-35396	0088381369046	5,50
29	50	38	1	D-17267	0088381195812	5,50
30	50	38	1	D-35405	0088381369053	5,70
32	44	38	1	D-17049	0088381194853	5,80
33	44	38	1	D-35411	0088381369060	6,00
35	44	38	1	D-17055	0088381194860	6,40
37	44	38	1	D-35427	0088381369077	6,40
38	44	38	1	D-17061	0088381194877	6,40
40	44	38	1	D-17273	0088381195829	6,70
41	44	38	1	D-35433	0088381369084	7,00
43	44	38	1	D-35449	0088381369091	7,30
44	44	38	1	D-17077	0088381194884	7,30
46	44	38	1	D-35455	0088381369107	7,90
48	44	38	1	D-35461	0088381369114	8,20
51	44	38	1	D-17083	0088381194891	8,50
52	44	38	1	D-35477	0088381369121	8,20
54	44	38	1	D-24876	0088381334778	8,20

Ø (mm)	Comp. (mm)	Comp. útil (mm)	Unds.	Código	EAN	P.V.P. (€)
56	44	38	1	D-35483	0088381369138	8,90
57	44	38	1	D-17099	0088381194907	8,90
59	44	38	1	D-35499	0088381369145	8,90
60	44	38	1	D-25688	0088381338516	8,90
64	44	38	1	D-30140	0088381351263	9,50
65	44	38	1	D-24882	0088381334785	9,50
67	44	38	1	D-35508	0088381369152	10,20
68	44	38	1	D-17108	0088381194914	10,20
70	44	38	1	D-25694	0088381338523	10,90
73	44	38	1	D-35514	0088381369169	11,20
76	44	38	1	D-17114	0088381194921	11,50
79	44	38	1	D-35520	0088381369176	11,50
83	44	38	1	D-17120	0088381194938	11,80
86	44	38	1	D-35536	0088381369183	11,80
89	44	38	1	D-35542	0088381369190	12,70
92	44	38	1	D-17136	0088381194945	12,70
95	44	38	1	D-35558	0088381369206	13,00
98	44	38	1	D-35564	0088381369213	13,30
102	44	38	1	D-35570	0088381369220	14,10
105	44	38	1	D-17142	0088381194952	14,60
108	44	38	1	D-35586	0088381369237	16,10
111	44	38	1	D-35592	0088381369244	16,60
114	44	38	1	D-35601	0088381369251	17,30
121	44	38	1	D-35617	0088381369268	17,90
127	44	38	1	D-17158	0088381194969	18,50
140	44	38	1	D-35623	0088381369275	20,00
152	44	38	1	D-17164	0088381194983	22,00



**Brocas de coroa**

**Adaptador com broca centradora para coroas Bi-Metálicas**



Ø (mm)	Tipo	Unds.	Código	EAN	P.V.P. (€)
14-29	10 Hex	1	D-17170	0088381194976	4,30
32-152	13 Hex	1	D-17186	0088381195003	7,90
14-29	SDS-PLUS	1	D-17603	0088381196727	6,40
32-76	SDS-PLUS	1	D-17619	0088381196734	10,40

**Broca centradora para coroas Bi-Metálicas**



Ø (mm)	Comp. (mm)	Unds.	Código	EAN	P.V.P. (€)
6	71	1	D-17192	0088381194990	3,20



**Estojos de brocas de coroa Bi-Metálicas**



D-47298

D-47117

Ø (mm)	Uso	Unds.	Código	EAN	P.V.P. (€)
19, 22, 25, 29, 35, 44, 51, 57, 68 e 75	Canalização	1	D-47298	0088381424370	109,00
19, 22, 29, 38, 44 e 57	Canalização	1	D-47117	0088381423731	48,00



D-47123

Ø (mm)	Uso	Unds.	Código	EAN	P.V.P. (€)
16, 20, 25, 32, 40 e 51	Eletricidade	1	D-47123	0088381423748	41,00
20, 25, 32, 40, 51 e 65	Eletricidade	1	D-47139	0088381423755	48,00

**Novo**



Ø (mm)	Unds.	Código	EAN	P.V.P. (€)
22, 29, 35, 44, 57, 64, 76, 92, 111, 127mm Inserção de 9,5 e 11mm. Adaptador e broca centradora.	1	D-75764	0088381597692	140,00



**Brocas de coroa Ezychange**



Brocas Bi-metálicas com cobalto adequadas para: madeira, metal, alumínio, aço inoxidável e plástico.



**ALTA QUALIDADE com 8% de COBALTO PARA UMA MAIOR DURAÇÃO**

Ø (mm)	Comp. (mm)	Comp. útil (mm)	Unds.	Código	EAN	P.V.P. (€)
16	-	44	1	E-03632	0088381561877	8,60
17	46	40	1	E-03648	0088381419161	8,60
19	46	40	1	E-03654	0088381561891	8,60
20	46	40	1	E-03660	0088381561907	8,60
22	46	40	1	E-03676	0088381561914	9,10
25	46	40	1	E-03698	0088381561938	11,00
27	46	40	1	E-03707	0088381561945	10,50
29	46	40	1	E-03713	0088381561952	10,50
32	46	40	1	E-03735	0088381561976	10,90
37	46	40	1	E-03757	0088381561990	11,60
38	46	40	1	E-03763	0088381562003	11,00
40	46	40	1	E-03779	0088381562010	12,10
41	46	40	1	E-03785	0088381562027	12,10
44	46	40	1	E-03791	0088381562034	12,70
46	46	40	1	E-03800	0088381562041	12,70
51	46	40	1	E-03822	0088381562065	13,20
52	46	40	1	E-03838	0088381562072	14,10
56	46	40	1	E-03850	0088381562096	15,10
57	46	40	1	E-03866	0088381562102	15,10

Ø (mm)	Comp. (mm)	Comp. útil (mm)	Unds.	Código	EAN	P.V.P. (€)
60	46	40	1	E-03872	0088381562119	15,10
65	46	40	1	E-03894	0088381562133	16,10
67	46	40	1	E-14152	0083381592437	22,00
68	46	40	1	E-03903	0088381562140	17,10
73	46	40	1	E-03925	0088381562164	17,30
76	46	40	1	E-03931	0088381562171	17,30
79	46	40	1	E-03947	0088381562188	20,00
83	46	40	1	E-03953	0088381562195	20,00
86	46	40	1	E-03969	0088381562201	21,00
89	46	40	1	E-14168	0083381592444	25,00
95	46	40	1	E-03981	0088381562225	27,00
105	46	40	1	E-04008	0088381562249	35,00
111	46	40	1	E-04014	0088381562256	43,00
114	46	40	1	E-04020	0088381562263	34,00
121	46	40	1	E-04036	0088381562270	39,00
127	46	40	1	E-04042	0088381562287	34,00
133	46	40	1	E-14174	0083381592451	56,00
140	46	40	1	E-04058	0088381562294	44,00
152	46	40	1	E-04064	0088381562300	45,00

**Adaptadores para coroas Ezychange**

**Broca centradora**



Comp.	Conteúdo	Unds.	Código	EAN	P.V.P. (€)
70 mm	Cilíndrico com broca centradora	1	E-04070	0088381562317	26,00

Tipo	Unds.	Código	EAN	P.V.P. (€)
HSS	1	E-04086	0088381562324	6,90

**Estojos de brocas de coroa Ezychange**



E-12304  
E-12310  
E-12326

E-14261

Ø (mm)	Unds.	Código	EAN	P.V.P. (€)
19,22,29,38,44,57	6	E-12304	0088381585668	163,00
16,20,25,32,40,51	6	E-12310	0088381585675	150,00
20,25,32,40,51,65	6	E-12326	0088381585682	163,00
22,25,32,44,51,68, adaptador e broca centradora	8	E-14261	0088381593632	260,00

**Brocas de coroa multimaterial Ezychange**



E-06644

E-14261

Ø (mm)	Profundidade de corte(mm)	Unds.	Código	EAN	P.V.P. (€)
20	60	1	E-06644	0088381570367	24,00
22	60	1	E-06650	0088381570374	25,00
25	60	1	E-06666	0088381570381	25,00
32	60	1	E-06672	0088381570398	27,00
35	60	1	E-06688	0088381570404	27,00
38	60	1	E-06694	0088381570411	28,00
40	60	1	E-06703	0088381570428	29,00
44	60	1	E-06719	0088381570435	30,00
51	60	1	E-06725	0088381570442	33,00
54	60	1	E-06731	0088381570459	41,00
60	60	1	E-06747	0088381570466	43,00
64	60	1	E-06753	0088381570473	43,00
67	60	1	E-06769	0088381570480	44,00
68	60	1	E-06775	0088381570497	44,00
70	60	1	E-06781	0088381570503	45,00
73	60	1	E-06797	0088381570510	46,00
76	60	1	E-06806	0088381570527	46,00
83	60	1	E-06812	0088381570534	48,00
102	60	1	E-06828	0088381570541	72,00
127	60	1	E-06834	0088381570558	155,00



**Adaptadores para coroa Ezychange**



Comprimento	Conteúdo	Unds.	Código	EAN	P.V.P. (€)
70 mm	Inclui broca centradora	1	E-06959	0088381570701	36,00
150 mm	Adaptador	1	E-06878	0088381570596	32,00
300 mm	Adaptador	1	E-06884	0088381570602	35,00



**Broca centradora**



Tipo	Unds.	Código	EAN	P.V.P. (€)
HSS-G	1	E-06840	0088381570565	10,70
HSS-CO	1	E-06856	0088381570572	15,00
TCT	1	E-06862	0088381570589	13,90



## Brocas de coroa HM

★★★★★

Brocas de coroa metal duro (alta durabilidade).

Com pastilhas de metal duro, preparadas para suportar as altas temperaturas produzidas pelo corte profundo e contínuo.

Para chapa de aço, aço inoxidável, vigas de ferro (duplo T), etc.

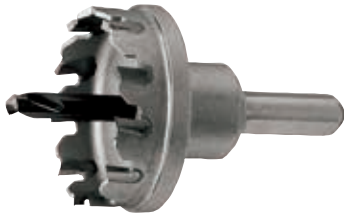

\* Para furos de espessura superior a 4 mm, recomenda-se o arrefecimento da broca.



Ø (mm)	Inserção (mm)	Tipo	Unds.	Código	EAN	P.V.P. (€)
16	6	HM	1	B-00898	0088381114004	52,00
18	6	HM	1	B-00907	0088381114011	55,00
20	6	HM	1	B-00913	0088381114028	55,00
21	6	HM	1	B-00929	0088381114035	55,00
22	6	HM	1	B-00935	0088381114042	55,00
25	10	HM	1	B-00941	0088381114059	55,00
27	10	HM	1	B-00957	0088381114066	56,00
30	10	HM	1	B-00979	0088381114080	58,00
32	10	HM	1	B-00985	0088381114097	67,00
35	10	HM	1	B-00991	0088381114103	67,00
38	10	HM	1	B-01002	0088381114110	79,00
40	10	HM	1	B-01018	0088381114127	80,00
45	10	HM	1	B-01024	0088381114134	88,00
48	10	HM	1	B-01030	0088381114141	97,00
50	10	HM	1	B-01046	0088381114158	101,00
90	13	HM	1	B-01127	0088381114288	253,00

## Brocas centradora para brocas HM



Ø (mm)	Tipo	Uso	Unds.	Código	EAN	P.V.P. (€)
6	HSS	Aço	1	B-01177	0088381114233	10,50

## Batedores

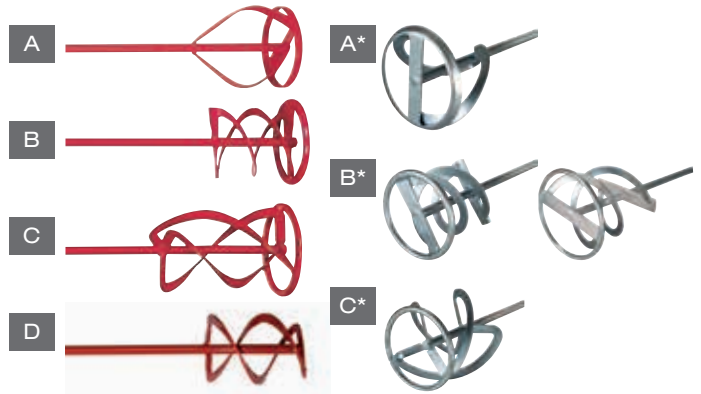

A	Para tintas, lacas, gesso, revestimentos finos, etc.
B e D	Todos os materiais viscosos, adequados para todos os tipos de argamassa, gesso, resinas de epóxi com enchimento de quartzo, etc.
C	Para todos os materiais pegajosos e viscosos, por exemplo, colagem de azulejos, argamassas, gessos, enchimentos, etc.

Inser.	Ø (mm)	Comp. (mm)	Tipo	Modelos	Unds.	Código	EAN	P.V.P. (€)	
8	80	400	A	DA6301 DS4010	1	P-02331	0088381918527	15,40	
10	90	400	D		1	P-02347	0088381918534	14,90	
8	100	590	C	UT1200 UT1400 UT1401 UT1600	1	P-02353	0088381918541	34,00	
M14	90	590	D		1	P-22028	0088381949088	27,00	
M14	120	590	A		1	P-22012	0088381949071	26,00	
M14	140	590	B		1	P-22040	0088381949101	33,00	
M14	120	590	C		1	P-22056	0088381949118	39,00	
M14	120	600	A*		1	D-73508	0088381584869	17,30	
M14	120	600	B*		1	D-73514	0088381584876	18,60	
M14	120	600	C*		1	D-73520	0088381584883	18,60	
3/8" hex					DA6301 DS4010		D-73536	0088381584890	11,80
10	120	600	B*			1	D-73542	0088381584906	11,10

## Adaptadores para batedores



Modo de utilização: Para utilizar um batedor de inserção M14 num berbequim, é necessário desmontar o porta-brocas, colocar o adaptador no seu lugar e inserir o batedor mais adequado para o tipo de trabalho na outra extremidade.

Ø (mm)	Inserção	Modelo	Unds.	Código	EAN	P.V.P. (€)
1/2"	M14	6013B/ DP4002	1	P-22062	0088381949125	15,00
5/8"	M14	DA6301	1	P-02325	0088381918510	11,00

## Disco misturador (sem haste A-43751)



Ø (mm)	Inserção	Modelo	Unds.	Código	EAN	P.V.P. (€)
165 mm	M8	DUT130	1	A-43692	0088381198707	14,40

## Vareta para misturador inox. A-43692



Ø (mm)	Inserção	Modelo	Unds.	Código	EAN	P.V.P. (€)
1/2"	M14	6013B/ DP4002	1	168349-5	0088381160261	26,00

★★★★★  
★★★★★  
★★★★★  
★★★★★



**Extensão DA4000LR**

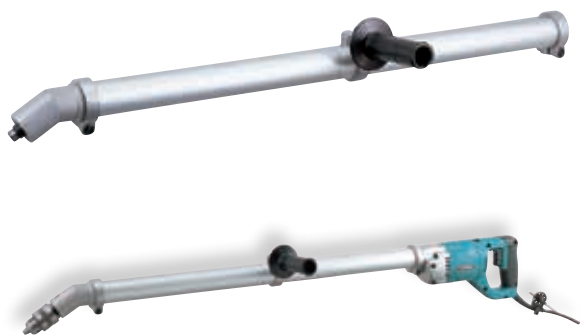

DA4000LR com extensão.

Modelos	Comp. (mm)	Unds.	Código	EAN	P.V.P. (€)
DA4000LR	760	1	193317-9	0088381160971	251,00

**Batentes de profundidade**



Modelos	Unds.	Código	EAN	P.V.P. (€)
DP2010 DP2011	1	322177-4	0088381126441	1,20
HP1620/1 HP2033 HP2050/1 HP2070/1	1	415486-9	0088381147033	0,95
DP4011	1	324219-0	0088381171458	2,00



**Suporte de berbequim e acessórios**

**Suporte de berbequim** [a]



\*Colar de aperto 43 mm.

Unds.	Código	EAN	P.V.P. (€)
1	A-36706*	0088381183130	396,00

**Suporte de paragem horizontal** [b]



Unds.	Código	EAN	P.V.P. (€)
1	501329	-	36,00

**Grampo horizontal** [c]

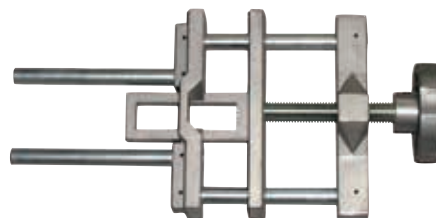

Unds.	Código	EAN	P.V.P. (€)
1	132126-1	-	169,00



**Suporte de guia e acessórios**

**Suporte de guia**

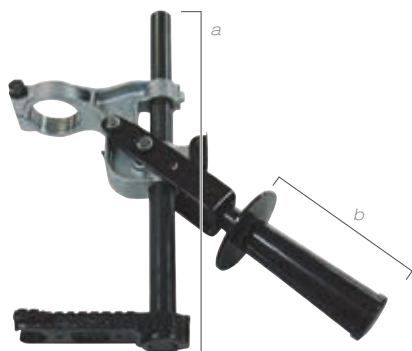

1

Peças	Unds.	Código	EAN	P.V.P. (€)
[a] Garra: 134279-2	1	501353	-	173,00
[b] Punho: 273466-9				
Kit suporte de guia para berbequim	1	134279-2	-	150,00

**Kit de suporte (base + alavanca)**



2

**Kit completo**  
(máquina não incluída)

Peças	Unds.	Código	EAN	P.V.P. (€)
[1+2] Kit completo	1	501043	-	198,00
[a] Alavanca: 155696-3	1	501035	-	27,00
[b] Parafuso: 924306-1				
[c] Parafusos (2 unds.): 912317-8				
[d] Base: 342802-1				

**Base em "V"**

Para utilizar com SUPORTE DE GUIA 501353

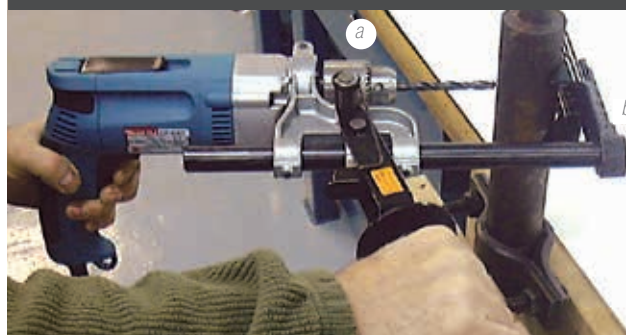

Peças	Unds.	Código	EAN	P.V.P. (€)
[a] Base em V: 163221-6	1	501036	-	11,00
[b] Parafuso: 911321-4				

**Batente de ajuste**

Para utilizar com SUPORTE DE GUIA 501353

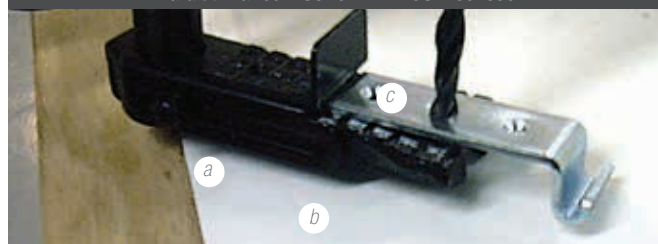

Peças	Unds.	Código	EAN	P.V.P. (€)
[a] Arruela: 941101-4	1	501037	-	4,70
[b] Parafuso: 251259-4				
[c] Batente: 342804-7				

**Alargador de base**

Para utilizar com SUPORTE DE GUIA 501353

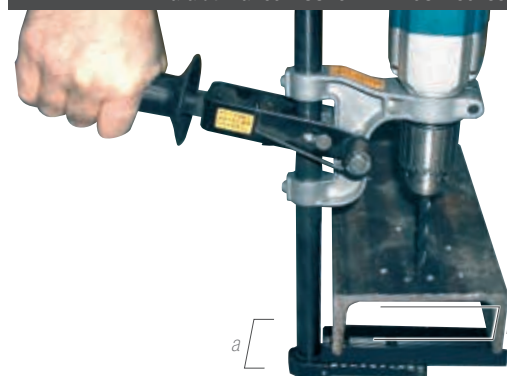

Peças	Unds.	Código	EAN	P.V.P. (€)
[a] Parafuso (2 unds.): 911321-4	1	501038	-	5,00
[b] Suplemento: 342818-6				



**Porta-brocas automático**

Tipo	Imagem	Modelos	Capacidade (mm)	Passo	Fecho/chave	Unds.	Código	EAN	P.V.P. (€)
Automático		HP1631 6310 HP1641	1,5 - 13	1/2" - 20	Lock	1	196193-0	0088381431460	39,00
		HP2051 HP2071 DP4011	1,5 - 13	1/2" - 20	Carraca	1	194254-0	0088381206907	51,00
		6317D 6337D 6347D	1,5 - 13	1/2" - 20	Standard	1	766010-4	-	31,00
		DP3003	1,0 - 10	1/2" - 20	Lock	1	193226-2	0088381150347	35,00
		6501X DP2011	0,8 - 6,5	3/8" - 24	Standard	1	193203-4	0088381157285	36,00
		6413	1,0 - 10	3/8" - 24	Standard	1	763180-0	0088381189156	10,00
		DF331D	1,0 - 10	3/8" - 24	-	1	763228-8	-	12,40
		HP331D	1,0 - 10	3/8" - 24	-	1	763229-6	-	10,10
		6261D 6271D 6281D	0,8 - 10	3/8" - 24	-	1	766002-3	0088381350549	10,50
		DF330D	0,8 - 10	3/8" - 24	-	1	766007-3	0088381354219	11,60
		8270D 8280D	0,8 - 10	1/2" - 20	-	1	763187-6	0088381196192	15,40
		6260D 6270D 6280D	0,8 - 10	1/2" - 20	-	1	763185-0	0088381192873	11,30
		8391D	0,8 - 10	1/2" - 20	-	1	766004-9	0088381359825	15,00
		DDF458 DF001G DHP458 DHP486 HP001G	1,5 - 13	1/2" - 20	-	1	763252-1	0088381584920	26,00





**Porta-brocas manual**

Tipo	Imagem	Modelos	Capacidade (mm)	Passo	Fecho/chave	Unds.	Código	EAN	P.V.P. (€)
Manual		6501 DP2010	0,5 - 6,5	3/8" - 24	763435-3	1	763077-3	0088381114837	5,60
		6413 6408 DA3011F	1,0 - 10	3/8" - 24	-	1	P-11835*	-	13,20
		HP1620	1,5 -13,0	1/2" - 20	763440-0	1	196008-1*	0088381433792	12,10
		HP1640	1,5 -13,0	1/2" - 20	763448-4	1	766016-2	-	9,60
		HP2050 HP2070 DS4012	1,5 -13,0	1/2" - 20	763430-3	1	193822-6*	0088381184250	28,00
		HP2010N 6300-4 6013B	1,5 -13,0	1/2" - 20	763432-9	1	192877-8	0088381147934	37,00
		DP4000 DP4002	1,5 -13,0	1/2" - 20	763434-5	1	193228-8	0088381158183	40,00
		DP3002	1,0 - 10,0	1/2" - 20	763434-5	1	193224-6	0088381158176	43,00
		DA4031	2,0 - 13,0	***	763432-9	1	193519-7	0088381164597	55,00
		DA6301	1,5 - 13,0	5/8" - 16	763432-9	1	763062-6	0088381102223	45,00
		DA4000LR	2,0 - 13,0	***	763432-9	1	193318-7	0088381160957	51,00
		DA3010F	1,0 - 10,0	**	763415-9	1	763174-5	0088381181945	41,00
		MT603	1,0 - 10,0			1	198911-2	0088381193078	7,20





# Aparafusar

**IMPACT BLACK**



*Impact*  
**PREMIER**



Índice

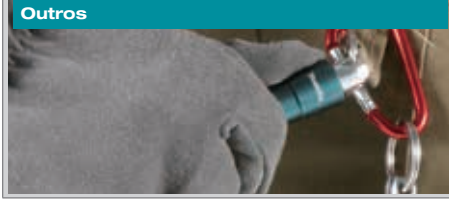
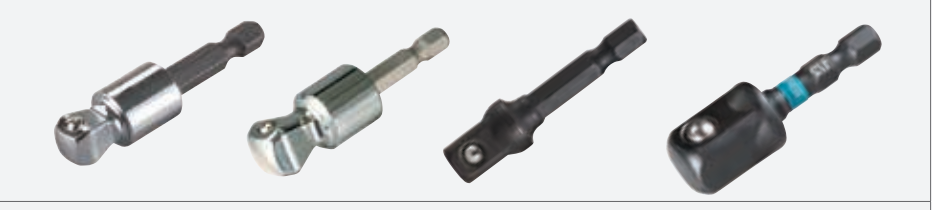
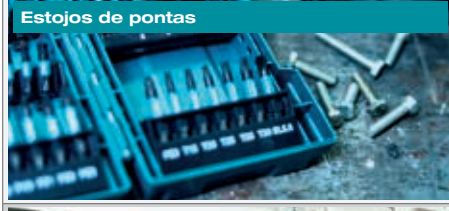
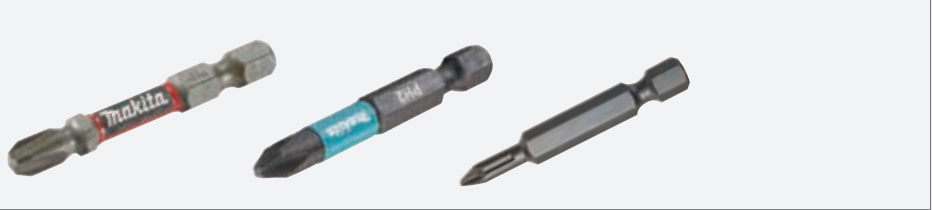
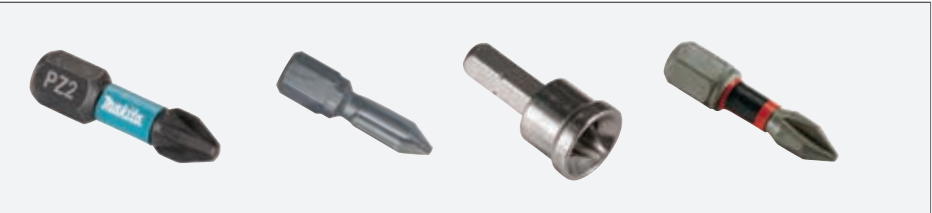

# Impact PREMIER



Apresentamos a nossa melhor gama de pontas, porta-pontas e chaves de caixa IMPACT PREMIER, uma gama redesenhada que aumenta a dureza e melhora a qualidade e durabilidade dos nossos acessórios.

- A nova forma de torção torna esta gama perfeita para o trabalho com aparafusadoras de impacto.
- Oferecem um grande ajuste da ponta no parafuso.
- Cada tipo de ponta é diferenciado por uma cor para facilitar o reconhecimento de cada uma.



## Impact PREMIER



**Maior precisão de ajuste.**

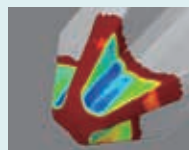

Com um parafuso próximo



Com um parafuso distante



Impact  
PREMIER



Padrão

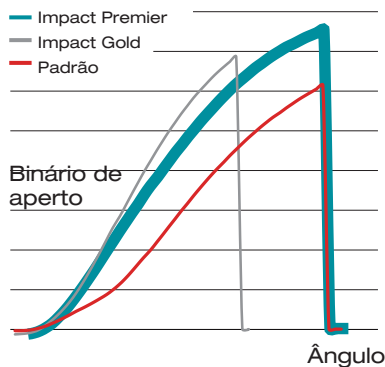

**Dupla torção para maior durabilidade.**



### Pontas Impact Premier



- Novo código de cor: Cada tipo de ponta tem uma cor associada.

★★★★★



E-03280

E-03296

E-03355

Ponta	Tipo	Comprimento (mm)	Unds.	Código	EAN	P.V.P. (€)
PH	PH1	25	2	E-03121	0088381569798	3,30
	PH2	25	2	E-03137	0088381569804	3,30
	PH3	25	2	E-03159	0088381569828	3,30
	PH1	50	2	E-03268	0088381569934	6,60
	PH2	50	2	E-03274	0088381569941	6,60
	PH3	50	2	E-03280	0088381570244	6,60
PZ	PZ1	25	2	E-03165	0088381569835	3,30
	PZ2	25	2	E-03171	0088381569842	3,30
	PZ3	25	2	E-03187	0088381569859	3,30
	PZ1	50	2	E-03296	0088381569958	6,60
	PZ2	50	2	B-63753	-	3,00
	PZ3	50	2	B-28298	0088381414210	6,60
T	T10	25	2	E-03193	0088381569866	3,30
	T15	25	2	E-03202	0088381569873	3,30
	T20	25	2	E-03218	0088381569880	3,30
	T25	25	2	E-03224	0088381569897	3,30
	T30	25	2	E-03230	0088381569903	3,30
	T40	25	2	E-12027	0088381585163	5,20
	T10	50	2	E-03327	0088381569989	6,60
	T15	50	2	E-03333	0088381569996	6,60
	T20	50	2	E-03349	0088381570008	6,60
	T25	50	2	E-03355	0088381570015	6,60
T30	50	2	E-03361	0088381570022	6,60	

### MagBoost

★★★★★



Mag Boost: porta-pontas magnético de 25 mm.

- Proporciona uma magnetização extra para uma forte fixação do parafuso.
- Ao contrário do Ultramag, o Mag Boost não é um porta-pontas, mas contacta-se diretamente à ponta.
- As pontas devem ter um mínimo de 50 mm. Ideal para pontas longas, qualquer que seja o comprimento, pode sempre ser colocado a apenas alguns milímetros da cabeça.
- Possui uma inserção cilíndrica e, portanto, também é compatível com aparafusadoras manuais (6,35 mm de diâmetro, 1/4" Hex.).



Descrição	Comp. (mm)	Unds.	Código	EAN	P.V.P. (€)
Íman	25	1	E-03442	0088381570107	4,40

### Chaves de caixa ajustáveis Impact Premier

★★★★★



Parafuso	Ø (mm)	Comp. (mm)	Unds.	Código	EAN	P.V.P. (€)
M8	13	80	1	E-03492	0088381570152	9,40
M10	17	80	1	E-03517	0088381570176	9,90
M12	19	80	1	E-03523	0088381570183	10,20

### Chaves de caixa magnéticas Impact Premier

★★★★★



Parafuso	Ø (mm)	Comp. (mm)	Unds.	Código	EAN	P.V.P. (€)
M3,5	6	65	1	E-03458	0088381570114	6,60
M5	8	65	1	E-03464	0088381570121	6,60
M6	10	65	1	E-03470	0088381570138	6,60
M8	13	65	1	E-03486	0088381570145	6,90

**Porta-pontas Ultramag Impact Premier**

★★★★★



Tipo	Comp. (mm)	Inserção	Unds.	Código	EAN	P.V.P. (€)
Magnético Neodímio	79	1/4"	1	E-03414	0088381570077	9,90

**Porta-pontas torção Impact Premier**

★★★★★



Tipo	Comp. (mm)	Inserção	Unds.	Código	EAN	P.V.P. (€)
Magnético	66	1/4"	1	E-03399	0088381570053	8,60
Magnético	150	1/4"	1	E-03408	0088381570060	9,40

**Adaptador inclinável**

★★★★★

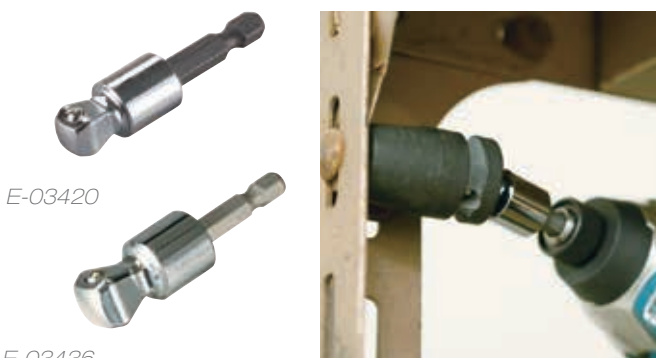

E-03420

E-03436

Inserção	Comp. (mm)	Unds.	Código	EAN	P.V.P. (€)
1/4" - 3/8"	56	1	E-03420	0088381570084	6,60
1/4" - 1/2"	56	1	E-03436	0088381570091	6,60

**Estojo de pontas Impact Premier**

- Porta-pontas magnético.
- Pontas de 25mm: PH1x1, PH2x5, PH3x2, PH3x2, PZ1x1, PZ2x5, PZ3x2, T10x1, T15x1, T20x3, T25X2, T30x2, H4x1, H5X1, H6x1, SL4x1, SL6x1.

★★★★★

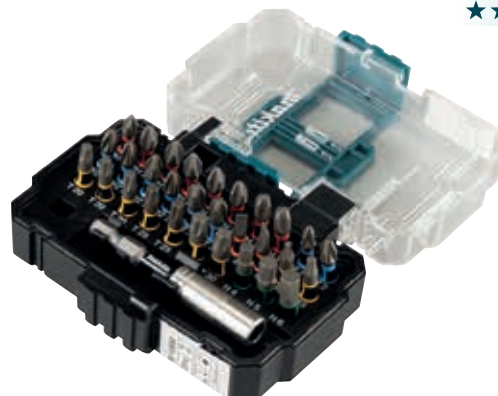

Conteúdo	Unds.	Código	EAN	P.V.P. (€)
31 peças	1	E-13552	0088381591577	40,00

- 5 pontas 50mm de comprimento: PH2, PZ2 PZ3, T25, T30.



Conteúdo	Unds.	Código	EAN	P.V.P. (€)
5 peças	1	E-13568	0088381591584	12,80

- Porta-pontas.
- Pontas PH: PH2.
- Pontas PZ: Pz1, 2x Pz2 e Pz3.
- Pontas T: T20, T25 e T30.
- Pontas planas: SL4 e SL6.



★★★★★

Conteúdo	Unds.	Código	EAN	P.V.P. (€)
11 peças	1	E-03573	0088381570213	25,00

**Pontas duplas Impact Premier**

★★★★★



Ponta	Tipo	Comp. (mm)	Unds.	Código	EAN	P.V.P. (€)
PH	PH2	65	2	E-06286	0088381570220	9,90
PZ	PZ2	65	2	E-06292	0088381570237	9,90



Pontas para aparafusar Impact Black



Estojes de pontas e chaves de caixa Impact Black



★★★



★★★

Conteúdo	Unds.	Código	EAN	P.V.P. (€)
Chaves de caixa impact black 1/4", 6 peças 6, 7, 8, 10, 12 e 13 mm	1	E-15768	0088381599818	19,30



★★★

Conteúdo	Unds.	Código	EAN	P.V.P. (€)
10 pontas de 50 mm: PH1, PH2, PH3, PZ1, PZ2, PZ3, T15, T20, T25, T30	1	E-12011	0088381589482	14,90



★★★

Conteúdo	Unds.	Código	EAN	P.V.P. (€)
7 pontas de 25 mm: PH1, PH2, PH3, PZ1, PZ2, PZ3, T15, T20, T25, T30	1	E-11994	0088381589468	8,80

Conteúdo	Unds.	Código	EAN	P.V.P. (€)
35 peças: PH 3xPH2 PH3 x 25mm PH1 2xPH2 PH3 x 50mm PZ1 3xPZ2 PZ3 x 25mm PZ1 2xPZ2 PZ3 x 50mm T 15 2xT20 2xT25 T30 x 25mm T15 T20 2xT25 T30 x 50mm SL5.5 x 50mm Chaves de caixa: 6,8,10,13mm Porta-pontas magnético 60mm	1	B-66880	0088381540018	43,00





## IMPACT BLACK



### Expositor de cartão Impact Black (12unds)

★★★



Conteúdo	Peças	Unds.	Código	EAN	P.V.P. (€)
25 pontas: PH2-25mm	25	12	E-12360-12	0088381586573	177,00
25 pontas: PZ2-25mm	25	12	E-12376-12	0088381586597	177,00
10 pontas: PH2-50mm	10	12	E-12407-12	0088381586658	133,00
10 pontas: PZ2-50mm	10	12	E-12413-12	0088381586726	133,00

### Expositor de cartão Impact Black (10unds)

★★★



Conteúdo	Peças	Unds.	Código	EAN	P.V.P. (€)
Conjunto de pontas	33	10	E-12441-10	0088381587792	243,00

### Guia de aparafusamento Impact Black

★★★



Descrição	Unds.	Código	EAN	P.V.P. (€)
Guia de aparafusamento 80 mm	1	B-66818	0088381539944	6,00

### Porta-pontas magnético Impact Black

★★★



Descrição	Unds.	Código	EAN	P.V.P. (€)
Porta-pontas magnético 60 mm	1	B-66793	0088381539920	4,90
	1	B-66802	0088381539937	4,80

### Chaves de caixa Impact Black

★★★



Descrição	Medidas (mm)	Unds.	Código	EAN	P.V.P. (€)
Chave de caixa magnética	6x50	1	B-66824	0088381539951	3,30
Chave de caixa magnética	8x50	1	B-66830	0088381539968	3,40
Chave de caixa magnética	10x50	1	B-66846	0088381539975	3,30
Chave de caixa magnética	13x50	1	B-66852	0088381539982	3,40



Pontas série Impact Black

★★★



PH

PZ

T

Descrição	Comp. (mm)	Unds.	Código	EAN	P.V.P. (€)
PH1	25	2	B-63600	0088381532877	1,75
PH2	25	2	B-63616	0088381532884	1,75
PH3	25	2	B-63622	0088381532891	1,75
PH1	50	2	B-63719	0088381532983	2,60
PH2	50	2	B-63725	0088381532990	2,60
PH3	50	2	B-63731	0088381533003	2,60
PZ1	25	2	B-63638	0088381532907	1,75
PZ2	25	2	B-63644	0088381532914	1,75
PZ3	25	2	B-63650	0088381532921	1,75
PZ1	50	2	B-63747	0088381533010	2,60
PZ2	50	2	B-63753	-	3,00
PZ3	50	2	B-63769	0088381533034	2,60
T15	25	2	B-63666	0088381532938	1,75
T20	25	2	B-63672	0088381532945	1,75
T25	25	2	B-63688	0088381532952	1,75
T30	25	2	B-63694	0088381532969	1,75
T40	25	2	B-63703	0088381532976	1,75
T15	50	2	B-63775	0088381533041	2,60
T20	50	2	B-63781	0088381533058	2,60
T25	50	2	B-63797	0088381533065	2,60
T30	50	2	B-63806	0088381533072	2,60
T40	50	2	B-63812	0088381533089	2,60
PH2	25	25	E-12360	0088381586566	14,60
PH2	50	10	E-12407	0088381586641	10,50
PZ2	25	25	E-12376	0088381586580	14,60
PZ2	50	10	E-12413	0088381586719	10,50
T20	25	25	E-12382	0088381586603	14,60
T25	25	25	E-12398	0088381586627	14,60
T30	25	25	E-12653	0088381588324	14,60
T40	25	25	E-12669	0088381588348	14,60
T20	50	10	E-12429	0088381586665	10,50
T25	50	10	E-12435	0088381586689	10,50
T30	50	10	E-12675	0088381588362	10,50
T40	50	10	E-12681	0088381588386	10,50

Troca de inserção Impact Black

★★★



B-66868

B-66874

Descrição	Unds.	Código	EAN	P.V.P. (€)
Porta-pontas magnético 60 mm 1/4" - 3/8"	1	B-66868	0088381539999	2,40
Porta-pontas magnético 60 mm 1/4" - 1/2"	1	B-66874	0088381540001	2,95





**Acessório autoalimentador aparafusamento**



- Converta a sua aparafusadora de paredes divisórias secas numa autoalimentada.
- Para colocação de pentes de parafusos padrão.

Parafusos	Modelos	Código	EAN	P.V.P. (€)
25-55 mm	DFS250 - DFS452 FS2300 FS4000 - FS6300R	191L24-0	0088381566414	102,00



Ponta PH2 130mm ( 5 Unds.) para 199146-8	199155-7	0088381528184	47,00
--	----------	---------------	-------

**Pontas para aparafusadoras autoalimentadas**



Tipo	Comp. (mm)	Modelos	Unds.	Código	EAN	P.V.P. (€)
PH	PH2 110	6830	1	P-13552	0088381922517	4,00
	PH2 117	DFR440	3	P-66793	0088381997324	13,20
	PH2 127	6832 6833 6835D	1	P-13568	0088381922524	6,30
	PH2 141	6834	1	P-21593	0088381948722	5,00
	PH2 155	DFR551	5	191V02-0	0088381585200	21,00
	PH2 157	6842 DFR550	3	P-67795	0088381998321	17,70
	PH2 177	6844	3	P-67804	0088381998338	21,00
PZ	PZ2 110	6830	1	P-13574	0088381922531	3,90
	PZ2 117	DFR440	3	P-66824	0088381997355	13,20
	PZ2 127	6832 6833 6835D	1	P-13580	0088381922548	6,00
	PZ2 141	6834	1	P-21618	0088381948746	22,00
	PZ2 155	DFR551	5	191V06-2	0088381585224	37,00
	PZ2 157	6842 DFR550	3	P-67773	0088381998307	17,70
	PZ2 177	6844	3	P-67789	0088381998314	21,00

**Ponta magnética para pladur**

★★★



Tipo	Comp. (mm)	Unds.	Código	EAN	P.V.P. (€)
PH PH2	30	1	D-61690	0088381477949	2,10

**Pontas**

★★★★



- Pontas altamente duradouras para aplicações profissionais e industriais.

Tipo	Comp. (mm)	Unds.	Código	EAN	P.V.P. (€)	
PH	PH1 25	10	P-06030	0088381946773	8,80	
	PH2 25	10	P-06052	0088381946797	8,80	
	PH3 25	10	P-06074	0088381946810	8,80	
	PH2 25	3	P-06052	0088381946797	8,80	
	PH1 50	10	P-06046	0088381946780	26,00	
	PH2 50	10	P-06068	0088381946803	25,00	
	PH3 50	10	P-06080	0088381946827	25,00	
PZ	PZ1 25	10	P-06096	0088381944328	8,80	
	PZ2 25	10	P-06111	0088381944335	8,80	
	PZ3 25	10	P-06133	0088381944342	8,80	
	PZ1 50	10	P-06105	0088381946834	25,00	
	PZ2 50	10	P-06127	0088381944571	25,00	
	PZ3 50	10	P-06149	0088381944588	25,00	
Plana	LS0,6 X 4,5	25	10	P-06177	0088381946865	14,30
	LS0,8 X 5,5	25	10	P-06199	0088381946889	14,30
Hex.	3,0 mm.	25	10	P-21375	0088381948524	22,00
	4,0 mm.	25	10	P-21381	0088381948531	22,00
	5,0 mm.	25	10	P-21397	0088381948548	22,00
	6,0 mm.	25	10	P-21406	0088381948555	22,00
T	T10 25	10	P-06323	0088381947015	14,30	
	T15 25	10	P-06339	0088381947022	14,30	
	T20 25	10	P-06345	0088381947039	14,30	
	T25 25	10	P-06351	0088381947046	14,30	
	T27 25	10	P-06367	0088381947053	14,30	
	T30 25	10	P-06373	0088381947060	14,30	
	T40 25	10	P-06389	0088381947077	14,30	



**Porta-pontas**

**Rapidfix**

★★★★

- Fixação segura e sem folgas do porta-pontas.
- O mecanismo de fixação especial deste porta-pontas permite a reter todo o tipo de pontas com acoplamento hexagonal de 1/4".
- Operação com uma mão para troca rápida da ponta.
- Elegante corpo metálico com casquilho funcional ergonómico. Suporta as condições mais difíceis de aparafusamento e perfuração.
- Recomendado para aparafusadoras de impacto.



Tipo	Comp. (mm)	Inserção	Unds.	Código	EAN	P.V.P. (€)
Clique	60	1/4"	1	P-54075	0088381984584	19,30

**Clickfix**

★★★★

- Magnético.
- Corpo robusto em alumínio.
- Fixação segura das pontas ou brocas.
- Operação com uma mão.
- Casquilho de guia giratório para um aparafusamento mais fácil e seguro.



Tipo	Comp. (mm)	Inserção	Unds.	Código	EAN	P.V.P. (€)
Magnético	60	1/4"	1	P-53263	0088381983778	18,70

**Porta-pontas 80mm para SDS-PLUS**

★★★



Comp. (mm)	Inserção	Unds.	Código	EAN	P.V.P. (€)
80	SDS - PLUS	1	B-57548	0088381519151	6,60

**Padrão**

★★

- Magnético.
- Corpo metálico robusto.
- Fixação segura das pontas.



Tipo	Comp. (mm)	Inserção	Unds.	Código	EAN	P.V.P. (€)
Magnético	60	1/4"	1	784811-8	0088381430807	4,00
	75	1/4"	1	784801-1	0088381114738	4,50

**Porta-pontas flexível**

★★★

- Porta-pontas magnético.
- Ideal para aparafusar em cantos ou arestas de difícil acesso.
- O eixo pode ser dobrado para alcançar lugares estreitos onde o aparafusamento é difícil.



Tipo	Comp. (mm)	Inserção	Unds.	Código	EAN	P.V.P. (€)
Magnético	200	1/4"	1	B-29072	0088381415507	7,30
Magnético	300	1/4"	1	B-29094	0088381415521	9,10

- Especial impacto.

★★★★★



Tipo	Comp. (mm)	Inserção	Unds.	Código	EAN	P.V.P. (€)
Magnético	300	1/4"	1	B-51867	0088381466806	36,00



Caixas especiais para colocação em haste rosçada

★★★

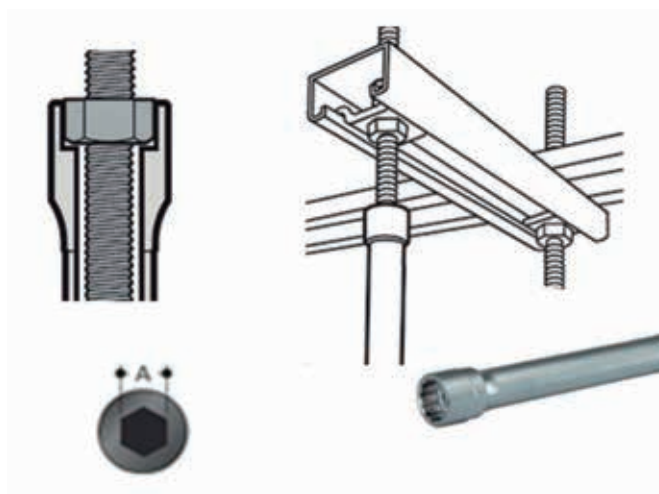

Ø (mm)	Comp. (mm)	Inserção	Unds.	Código	EAN	P.V.P. (€)
10	150	1/4"	1	B-52532	0088381469111	27,00
10	300	1/4"	1	B-52548	0088381469128	29,00
10	500	1/4"	1	B-52554	0088381469135	49,00
13	150	1/4"	1	B-52582	0088381469166	27,00
13	300	1/4"	1	B-52598	0088381469173	29,00
13	500	1/4"	1	B-52607	0088381469180	49,00
17	150	1/4"	1	B-52635	0088381469210	29,00
17	300	1/4"	1	B-52641	0088381469227	32,00
17	500	1/4"	1	B-52657	0088381469234	51,00



Chaves de caixa 1/4" magnéticas

★★

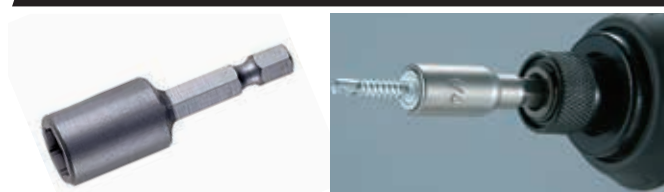

Parafuso	Ø (mm)	Comp. (mm)	Unds.	Código	EAN	P.V.P. (€)
M3	5,5	50	1	B-38685	0088381433327	2,40
M3,5	6	50	1	B-38691	0088381433334	2,40
M4	7	50	1	B-38700	0088381433341	4,80
M5	8	50	1	B-38716	0088381433358	2,45
M6	10	50	1	B-38722	0088381433365	2,40
M8	12	50	1	B-38738	0088381433372	2,45
M8	13	50	1	B-38744	0088381433389	4,90
M10	17	50	1	B-38750	0088381433396	4,90
Para modelo FS2500 e FS2700						
M6	10	65	1	784806-1	0088381114585	22,00
1/2"	12,7	65	1	784805-3	0088381102735	24,00

Kit de montagem rápida

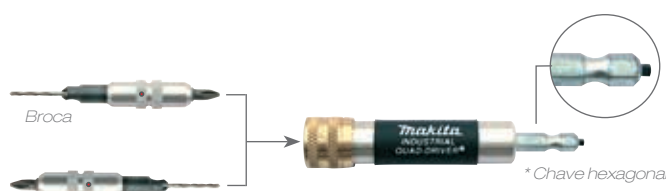

Ø (mm)	Unds.	Código	EAN	P.V.P. (€)
8	1	P-44074	0088381974271	12,70



Chaves de caixa para colocação de varão roscado

★★★★★



Ø (mm)	Inserção	Unds.	Código	EAN	P.V.P. (€)
6	1/4"	1	B-42961	0088381441995	19,30
8	1/4"	1	B-42977	0088381442008	20,00
10	1/4"	1	B-42983	0088381442015	20,00

Adaptador troca de inserção

★★



Descrição	Unds.	Código	EAN	P.V.P. (€)
Adaptador 1/4 a 3/8"50mm.	1	B-54667	0088381478380	2,90
Adaptador 1/4 a 1/2"50mm.	1	B-54673	0088381478397	3,80
Adaptador 1/4 a 3/8"150mm.	1	B-57738	0088381521994	9,30
Adaptador 1/4 a 1/2"150mm.	1	B-57744	0088381522007	11,40

Adaptador troca de inserção



Descrição	Unds.	Código	EAN	P.V.P. (€)
Adaptador 1/4 a 1/4" 50mm.	1	D-74740	0088381589512	1,65

Conjunto de chaves de caixa hexagonal

★★



Tamanho (mm)	Comp. (mm)	Unds.	Código	EAN	P.V.P. (€)
8 - 10 - 12 - 13	48	1	B-57554	0088381519168	6,70

Guia de aparafusamento

★★



B-52934

B-48773



Conteúdo	Comp. (mm)	Unds.	Código	EAN	P.V.P. (€)
Guia 80 mm	80	1	B-48751	0088381455756	5,10
Guia 120 mm	120	1	B-52934	0088381471312	5,80
Guia 120 mm	120	1	B-48767	0088381455763	6,40
Guia 80 mm 5 PH2 5 PZ2 5 T20 5 T25 5 T30	80	1	B-48773	0088381455770	17,50
Guia 120 mm 5 PH2 5 PZ2 5 T20 5 T25 5 T30	120	1	B-48789	0088381455787	17,50

**Estojo de pontas (7 peças)** ★★



- Pontas 25mm: PH1, PH2, SL3, SL5, PZ2 e PZ3.
- Compacto e ideal para o transporte.
- Conteúdo visível graças à tampa transparente.
- Porta-pontas magnético.

Conteúdo	Unds.	Código	EAN	P.V.P. (€)
6 pontas + porta-pontas	1	D-73271	0088381582391	4,40

**Embalagem de pontas magnéticas a granel** ★★★

- 100 pontas duplas magnéticas.
- Disponíveis no tipo PH n.º 2 e PZ n.º 2.
- Inserção de 1/4" hexagonal indicada para para aparafusadoras de impacto e berbequins aparafusadores.
- Pontas duplas de 65 mm de comprimento.



Comprimento (mm)	Tipo	Unds.	Código	EAN	P.V.P. (€)
65	Dulpa PH2	1	D-31669	0088381356503	54,00
65	Dulpa PZ2	1	D-34914	0088381367080	54,00

**Frasco de pontas a granel** ★★

- Disponíveis no tipo PH n.º2 e PZ n.º2 de 25mm e 50mm.
- Pontas magnéticas de 25mm de largo.



Comprimento (mm)	Tipo	Unds.	Código	EAN	P.V.P. (€)
25	PH2	100	B-24876	0088381409193	29,00
25	PZ2	100	B-24882	0088381409209	29,00
50	PH2	50	B-26490	0088381410229	28,00
50	PZ2	50	B-26509	0088381410236	28,00

**Estojos de pontas** ★★



Conteúdo	Unds.	Código	EAN	P.V.P. (€)
31 peças por estojo: 1xPH0, 1xPH1, 4xPH2, 1xPH3 1xPZ0, 1xPZ1, 4xPZ2, 1xPZ3 1xT10, 1xT15, 2xT20, 2xT25, 1xT27, 1xT30, 1xT40 1xH3, 1xH4, 1xH5, 1xH6 Planas: 4,5 / 5,5 / 6,5 Porta-pontas magnético	12	E-00022	0088381553155	235,00
	1	B-68317	0088381545983	25,00



Conteúdo	Unds.	Código	EAN	P.V.P. (€)
31 Peças: 2xPh1, 4xPh2, 1xPh3 2xPz1, 5xPz2, 1xPz3 2xT10, 2xT15, 2xT20 3xT25, 2xT30, 1xT40 4 5,5 6,5mm Porta-pontas magnético	1	D-30667	0088381354295	12,10

**Pontas duplas magnéticas** ★★★

- Pack com dez pontas duplas com dispensador.
- 10 pontas duplas magnéticas.
- Inserção de 1/4" hexagonal válida para aparafusadoras de impacto e berbequins aparafusadores.
- Ponta dupla de 65mm de comprimento.



Medida (mm)	Tipo de ponta	Unds.	Código	EAN	P.V.P. (€)
65	Dulpa PH2	1	D-34366	0088381365550	9,80

**Estojo de pontas (11 peças)** ★★

- Porta-pontas magnético.
- Ponta PH2.
- Pontas PZ: PZ1, PZ2 e PZ3.
- Pontas T: T10, T15, T20, T25, T30 e T40.



Medida (mm)	Conteúdo	Unds.	Código	EAN	P.V.P. (€)
25	11 peças	1	D-64995	0088381533782	10,40

### Estojo de pontas (11 peças)



- Porta-pontas magnético.
- PH2.
- PZ1.
- PZ2.



Medida (mm)	Conteúdo	Unds.	Código	EAN	P.V.P. (€)
25	11 peças	1	P-16782	0088381932783	17,10

### Estojo de pontas e caixas



- Pontas PZ: PZ1x2, PZ2x2, PZ3x2.
- Pontas PH: PH1x2, PH2x2, PH3x2.
- Pontas hexagonais: H2, H2.5, H3, H4x2, H5x2, H6x2.
- Pontas planas: SL4.5x2, SL5.5x2, SL6.5x2.
- Pontas T: T10x2, T15x2, T20x2, T25x2, T30x2, T40
- Chaves de caixa: Hex5, Hex6, Hex7, Hex8, Hex9, Hex10, Hex10, Hex11.
- Porta-pontas magnético.
- Chave de fendas manual com roquete.



Conteúdo	Unds.	Código	EAN	P.V.P. (€)
47 peças	1	B-36170	0088381433549	33,00

### Estojo de pontas e chave de roquete



- Pontas PZ1, PZ2.
- Pontas PH1, PH2, PH3.
- Pontas hexagonais H4, H6.
- Pontas planas SL0,8x5.5, SL1,2x6.5.
- Pontas T T20, T25, T30.
- Chaves de caixa Hex5, Hex6, Hex8, Hex10, Hex12, Hex13.
- Ponta 1/4"Hex.
- Porta-pontas magnético.
- Roquete.



Conteúdo	Unds.	Código	EAN	P.V.P. (€)
21 peças	1	B-54081	0088381476966	36,00

### Chave estrela de pancada

- Ideal para parafusos bem apertados que não podem ser desaparafusados com ferramentas elétricas ou que são muito difíceis de libertar com uma chave de fendas manual.
- Utiliza a força do impacto para gerar uma força oposta que acaba por desaparafusar o parafuso. Dispõe de uma mola no interior que, ao ser golpeada pelo martelo, comprime-se e liberta a referida força em forma de rotação.



Ponta	Comp. (mm)	Unds.	Código	EAN	P.V.P. (€)
PH2	125	1	B-42438	0088381440226	20,00
PZ2	125	1	B-42450	0088381440240	20,00

### Estojo de pontas



- Pontas PZ PZ0, PZ1, PZ2x2, PZ3.
- Pontas PH PH0, PH1, PH2x2, PH3.
- Pontas hexagonais H3, H4, H5, H6.
- Pontas planas SL4, SL4.5, SL5.5, SL6.5
- Pontas T T10, T15, T20x2, T25x2, T27, T30x2, T40
- Pontas T de segurança T10H, T15H, T20H, T25H, T27H, T30H, T40H.
- Porta-pontas magnético.



Conteúdo	Unds.	Código	EAN	P.V.P. (€)
37 peças	1	B-28606	0088381414807	24,00



**Conjunto ferramentas manuais (76 peças)**

★★★

- Chave de roquete 3/8".
- Chave de fendas para pontas 1/4.
- Cortador.
- Chave de fendas para caixas 1/4".
- Martelo 180mm.
- Alicates 150 mm.
- Alicates de ponta fina 150mm.
- Caixas longas 3/8": 8mm - 9mm - 10mm - 11mm - 12mm - 13mm - 14mm - 15mm - 16mm - 17mm - 18mm - 19mm - 20mm - 21mm.
- Caixas 1/4": 4 - 5 - 6 - 7 - 8.
- Porta-pontas magnético.
- Conjunto de chaves de caixa 1/4": 5 - 6 - 7 - 8 - 9 - 10 - 11.
- Adaptador de caixa 1/2" 1/4" - 3/8".
- Pontas 25mm 1/4": PH1 - PH2 - PH3 - T8 - T9 - T10 - T15 - T20 - T25 - T27 - T30 - T40 - T8H - T10H - T15H - T20H - T25H - T27H - T30H - T40H - SL 0,5X3,0 - SL 0,8X4,0 - SL 0,8X5,0 - SL 1,0X5,5 - SL 1,0X6,0.
- Extensores para caixas 3/8" 75mm 150mm.
- Rótulas 1/4" e 3/8".



Conteúdo	Unds	Código	EAN	P.V.P. (€)
76 peças	1	E-10899	0088381581493	109,00



### Estojo de pontas e caixas (30 peças)

- Pontas 25 mm PH, PZ, T, Hex e planas. ★★
- Pontas 50 mm PH, PZ, T e planas.
- Porta-pontas magnético.
- Adaptador para caixas 3/8".
- Caixas 3/8" 63 mm: 17 e 19 mm.
- Caixas 1/4" hex. magnéticos 8 e 10 mm.



Conteúdo	Unds	Código	EAN	P.V.P. (€)
30 peças	1	E-07060	0088381571265	33,00



### Mala de ferramentas manual (120 peças)

- Chave de roquete 3/8".
- Caixas 1/4" 25mm: 4, 4.5, 5, 5.5, 6, 7, 8, 9, 10, 11, 12, 13 e 14mm.
- Caixas 3/8" 28 e 30mm: 8, 9, 10, 11, 12, 13, 14, 15, 16, 17, 18, 19, 20 e 21mm.
- Caixas estrela 1/4" 25mm: E4, E5, E6, E7 e E8.
- Caixas estrela 3/8" 28 e 30mm: E10, E11, E12, E14, E16 e E18.
- Caixas longas 1/2" de 16 e 21mm.
- Adaptadores 3/8", 1/4" e 1/2".
- Extensões para caixas 1/4" e para caixas 3/8".
- Rótulas de 1/4" e 3/8".
- Chaves fixas combinadas de 8, 10, 11, 12, 13, 14 e 15mm.
- Chave manual 1/4".
- Porta-pontas magnético e guia de aparafusamento.
- Pontas planas, PH, PZ, T, Hex...



Conteúdo	Unds	Código	EAN	P.V.P. (€)
120 peças	1	E-06616	0088381570251	138,00



**Conjunto de chaves, pontas e caixas (221 peças)**

★★★

- Chave de roquete 1/4" e 1/2".
- Chave manual 1/4".
- Extensões para caixas 1/4" e para caixas 1/2".
- Adaptador 3 posições de 1/2" a 3/8".
- Rótulas de 1/4" e 1/2".
- Caixas 1/4" de 25 mm: 4, 4.5, 5, 5.5, 6, 7, 8, 9, 10, 11, 12, 13 e 14.
- Caixas 1/2" de 38 mm: 15, 16, 17, 19, 20, 21, 22, 24, 27, 30 e 32.
- Caixas estrela 1/2" de 38 mm: E10, E12, E14, E16, E18, E20 e E24.
- Caixas 1/4" hex. de 38 mm: 5, 5.5, 6, 7, 8, 9, 10, 11, 12 e 13.
- Chaves fixas combinadas de 8 a 19 mm.
- Conjunto de chaves allen de 1.5 a 8 mm.
- Cabo de chave de fendas.
- Pontas planas, PH, PZ, T, Hex...
- Porta-pontas magnético.



Conteúdo	Unds	Código	EAN	P.V.P. (€)
221 peças	1	E-10883	0088381581486	215,00

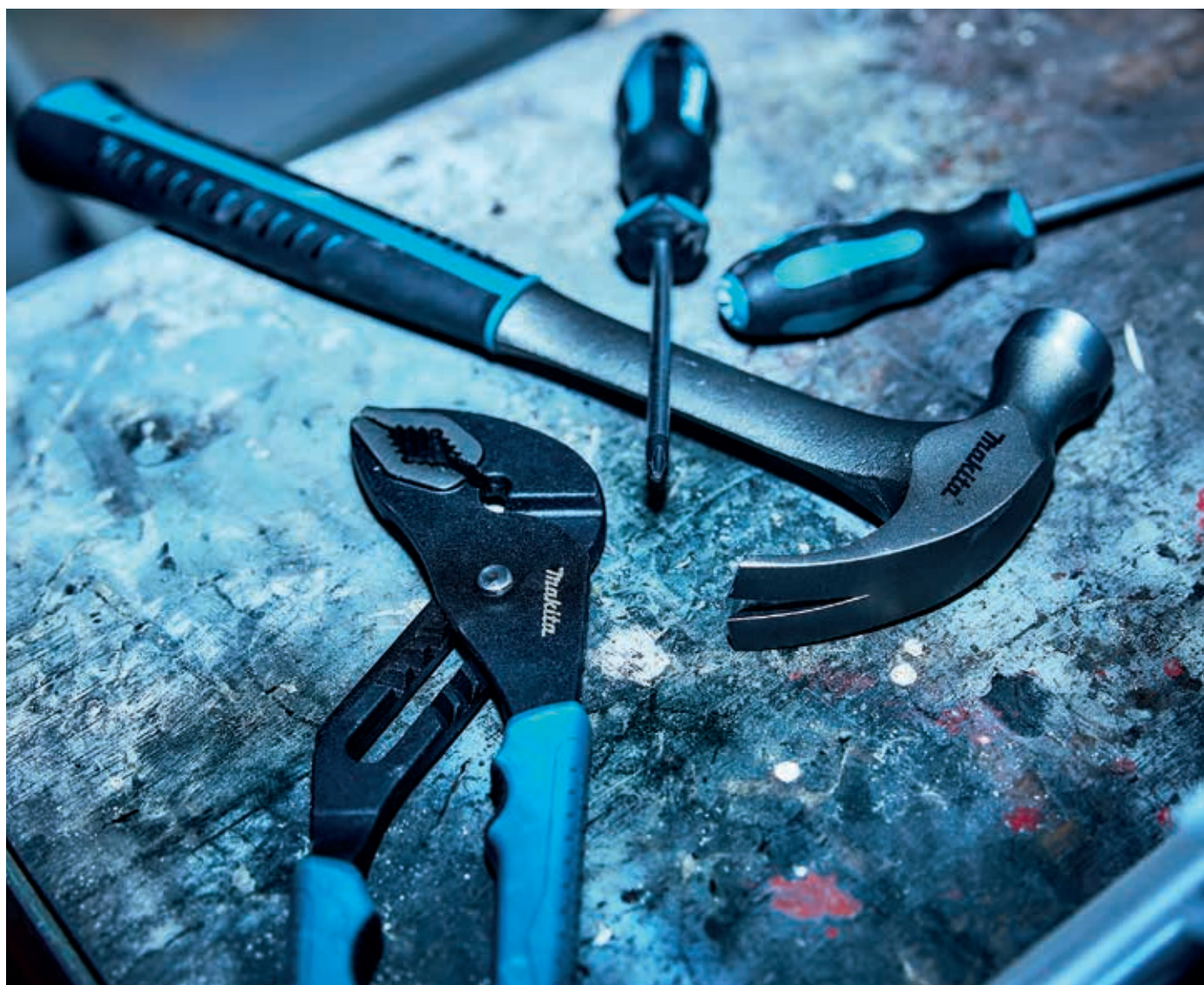

Chaves de caixa CR-MO (sem cavilha nem anilha)



★★★



★★★

\*Não inclui cavilha nem anilha de borracha.

Inserção	Métrica	Ø int (mm)	Ø ext (mm)	Comp. (mm)	Código	EAN	P.V.P. (€)
3/8"	-	6	11	28	B-39883	0088381436595	3,80
3/8"	-	7	12	28	B-39899	0088381436601	3,80
3/8"	-	8	13	28	B-39908	0088381436618	3,80
3/8"	-	9	14	28	B-39914	0088381436625	3,80
3/8"	-	10	15	28	B-39920	0088381436632	3,80
3/8"	-	11	18	28	B-39936	0088381436649	3,80
3/8"	M7	12	18	28	B-39942	0088381436656	3,70
3/8"	M8	13	20	28	B-39958	0088381436663	4,40
3/8"	M8	14	20	28	B-39964	0088381436670	4,40
3/8"	-	15	22	28	B-39970	0088381436687	4,70
3/8"	-	16	24	28	B-39986	0088381436694	4,70
3/8"	M10	17	24	28	B-39992	0088381436700	4,70
3/8"	-	18	28	28	B-40004	0088381436717	5,20
1/2"	-	10	15	38	B-40076	0088381436786	3,20
1/2"	M7	12	18	38	B-40098	0088381436809	3,20
1/2"	M8	13	20	38	B-40107	0088381436816	3,20

Inserção	Métrica	Ø int (mm)	Ø ext (mm)	Comp. (mm)	Código	EAN	P.V.P. (€)
1/2"	M8	13	20	81,5	B-52180	0088381467827	3,70
1/2"	M8	14	20	38	B-40113	0088381436823	3,20
1/2"	M10	16	24	38	B-40135	0088381436847	3,70
1/2"	M10	17	24	38	B-40141	0088381436854	3,70
1/2"	M10	17	24	81,5	B-52211	0088381467858	4,80
1/2"	M12	19	28	38	B-40163	0088381436878	4,00
1/2"	M12	19	28	81,5	B-52233	0088381467872	5,60
1/2"	M14	21	30	38	B-40185	0088381436892	4,00
1/2"	M14	21	30	81,5	B-52249	0088381467889	6,40
1/2"	M14	22	30	38	B-40191	0088381436908	4,50
1/2"	M14	23	30	38	B-40200	0088381436915	5,90
1/2"	M16	24	30	38	B-40216	0088381436922	6,20
1/2"	M18	27	36	38	B-40222	0088381436939	6,40
1/2"	M20	30	40	44	B-40238	0088381436946	7,20
1/2"	M22	32	42	44	B-40244	0088381436953	10,40

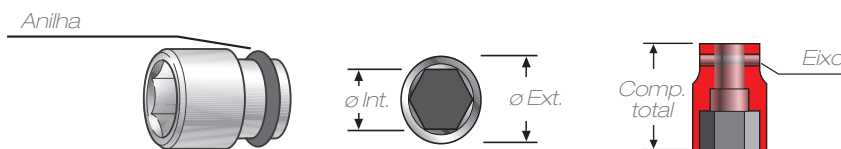

Anilha de borracha - Cavilha



Tipo	Código	EAN	P.V.P. (€)
A	213397-0	-	1,20
B	213398-8	0088381155496	1,20
C	213399-6	0088381495240	1,20
D	213461-7	3240890114174	1,20
E	213482-9	-	1,20
F	213570-2	0088381200028	1,60

Tipo	Código	EAN	P.V.P. (€)
1	268056-1	-	1,20
2	268057-9	0088381162708	1,20
3	256283-2	-	1,20
4	256282-4	0088381495431	1,20
5	256284-0	0088381200035	2,10

Chaves de caixa (com cavilha e anilha)



Tipo	Inserção	Métrica	Ø int (mm)	Ø ext (mm)	Comp. (mm)	Código	EAN	P.V.P. (€)	
A	1	1/2"	M7	12	19	38	A-89931	0088381185882	4,40
		1/2"	M7	12	25	75	134867-5	0088381152488	35,00
		1/2"	M8	13	25	38	134825-1	0088381148948	5,20
		1/2"	M8	13	26	52	134827-7	0088381148955	6,90
		1/2"	M8	14	25	38	134826-9	0088381160704	5,20
		1/2"	M8	14	25	52	134828-5	0088381170178	5,50
		1/2"	-	16	25	38	B-10506	0088381343299	5,20
		1/2"	M10	17	26	38	134829-3	0088381148962	5,20
		1/2"	M10	17	26	52	134830-8	0088381148979	5,20
B	1/2"	M12	19	28	38	134831-6	0088381148986	6,00	
		M12	19	28	52	134832-4	0088381148993	6,00	
C	1/2"	M12	19	30	78	134837-4	0088381161824	8,60	
B	1/2"	M14	21	28	52	134833-2	0088381161794	7,70	
C	1/2"	M14	21	30	78	134839-0	0088381161831	9,40	
B	2	1/2"	M14	22	30	38	134851-0	0088381149006	6,90
		1/2"	M14	22	28	52	134834-0	0088381149013	7,70
		1/2"	M14	23	30	38	134840-5	0088381161800	6,90
		1/2"	M14	23	28	52	134835-8	0088381170499	8,20
		1/2"	M16	24	30	45	134841-3	0088381149020	8,20
		1/2"	M16	24	28	52	134836-6	0088381149037	8,60
		1/2"	M16	26	30	50	134842-1	0088381161770	9,10
		1/2"	M16	26	30	75	134843-9	0088381161817	11,60
		1/2"	M18	27	30	50	134844-7	0088381149044	8,20
		1/2"	M18	27	30	78	134845-5	0088381149051	12,70
C	2	1/2"	M20	30	30	50	134846-3	0088381149068	9,90
		1/2"	M20	30	30	78	134847-1	0088381149075	13,20
		1/2"	M22	32	30	50	134848-9	0088381149082	9,60
		1/2"	M22	32	30	78	134849-7	0088381149099	13,80

Tipo	Inserção	Métrica	Ø int (mm)	Ø ext (mm)	Comp. (mm)	Código	EAN	P.V.P. (€)	
D	3	3/4"	M10	17	28	50	A-85494	0088381158817	10,50
E	4	3/4"	M10	17	31	95	A-85503	0088381158824	21,00
D	3	3/4"	M12	19	30	50	A-85519	0088381158831	11,00
E	4	3/4"	M12	19	33	95	A-85525	0088381158848	21,00
D	3	3/4"	M14	21	32	52	A-85531	0088381158855	11,00
E	4	3/4"	M14	21	35	95	A-85547	0088381158862	21,00
D	3	3/4"	M14	22	34	52	A-85553	0088381158879	11,00
E	4	3/4"	M14	22	37	95	A-85569	0088381158886	21,00
D	3	3/4"	M16	24	36	52	A-85575	0088381158893	11,00
E	4	3/4"	M16	24	39	95	A-85581	0088381158909	20,00
D	3	3/4"	M16	26	38	52	134853-6	0088381149105	12,10
E	4	3/4"	M16	26	44	95	134854-4	0088381149112	25,00
D	3	3/4"	M18	27	38	52	134855-2	0088381149129	11,00
		3/4"	M18	27	44	95	134856-0	0088381149136	22,00
		3/4"	M20	30	44	52	134857-8	0088381149143	11,00
		3/4"	M20	30	44	95	134858-6	0088381149150	19,30
		3/4"	M22	32	44	52	134871-4	0088381149167	11,00
		3/4"	M22	32	44	95	134859-4	0088381149174	20,00
		3/4"	M22	35	44	56	134860-9	0088381149181	14,30
		3/4"	M22	35	44	95	134861-7	0088381149198	27,00
		3/4"	M24	36	44	56	134862-5	0088381149204	16,00
		3/4"	M24	36	44	95	134863-3	0088381149211	24,00

Tipo	Inserção	Métrica	Ø int (mm)	Ø ext (mm)	Comp. (mm)	Código	EAN	P.V.P. (€)	
F	5	1"	M22	35	52	80	134864-1	0088381200882	25,00
		1"	M24	36	52	80	134865-9	0088381200899	24,00
		1"	M27	41	52	80	134872-2	0088381200011	26,00

Estojo de chaves de caixa 9 peças



- Estojo de 9 peças com espuma interior para uma boa conservação das caixas.
- Cada caixa está equipada com a sua própria anilha de borracha e cavilha, para uma fixação perfeita à máquina.
- Informação sobre a composição: CR-MO (Crómio - molibdéneo)



Inserção	Ø int. (mm)	Ø ext. (mm)	Comp. (mm)	Código	EAN	P.V.P. (€)
1/2"	8	15	38	D-41517	0088381404334	58,00
1/2"	10	17,5	38			
1/2"	13	20	38			
1/2"	16	24	38			
1/2"	17	26	38			
1/2"	18	28	38			
1/2"	19	28	38			
1/2"	21	30	38			
1/2"	24	34	38			

**Jogo de caixas de impacto 12 peças**



Inserção	Ø int. (mm)	Comp. (mm)	Código	EAN	P.V.P. (€)
1/4"	6	23	E-12289	0088381589529	14,90
	7	23			
	8	23			
	10	23			
	11	23			
	12	23			
	13	23			



**Jogo de chaves de caixa para automóvel**

★★★



Inserção	Ø int. (mm)	Ø ext. (mm)	Comp. (mm)	Código	EAN	P.V.P. (€)
1/2"	3	17	86	E-12354	0088381586528	33,00
1/2"		19				
1/2"		21				

**Adaptadores de inserção para DWR180 e WR100D**



Modelos	Unds.	Código	EAN	P.V.P. (€)
Para caixas 3/8"	1	191A50-3	0088381546744	22,00
Para caixas 1/4"	1	191A51-1	0088381546737	22,00

**Batente de profundidade para aparafusadoras de impacto**



Modelos	Unds.	Código	EAN	P.V.P. (€)
TD0101F DTD145 DTD146	1	194281-7	0088381276108	30,00

**Acessórios para DTL061**



134745-9

192439-2

192440-7

Descrição	Unds.	Código	EAN	P.V.P. (€)
Adaptador de 3/8"	1	134745-9	0088381134361	20,00
Adaptador 1/2"	1	134746-7	0088381142632	20,00
Cabeça de roquete	1	192439-2	0088381128742	165,00
Cabeça reta	1	192440-7	0088381128759	74,00

**Extensão**



Inserção	Comp. (mm)	Unds.	Código	EAN	P.V.P. (€)
1/2"	100	1	134874-8	0088381149228	25,00
3/4"	150	1	134997-2	0088381194730	52,00
1"	200	1	134870-6	0088381150200	72,00



Rótula



Inserção	Comp. (mm)	Unds.	Código	EAN	P.V.P. (€)
1/2"	80	1	134877-2	0088381149242	71,00
3/4"	105,5	1	134998-0	0088381206891	107,00

Adaptadores de inserção



P-05941

P-05963

B-68448

Inserção	Saída	Comp. (mm)	Unds.	Código	EAN	P.V.P. (€)
1/2"	1/4"	47	1	P-05941	0088381946681	46,00
3/8"	1/4"	37	1	P-05963	0088381946704	40,00
1/2"	1/4"	47	1	B-68448	0088381546287	17,30

★★★★

★★★★

★★★

Cabo de extensão



Modelo	Comp. (mm)	Unds.	Código	EAN	P.V.P. (€)
6844 6842 DFR440 DFR550	890 - 990	1	194500-1	0088381342377	89,00

Gancho para cinto



Modelos	Unds.	Código	EAN	P.V.P. (€)
DTD129 DTD148 DTD154 DTD170 DTD171 DTD172	1	197043-2	0088381447362	32,00

Cabo de extensão



Modelo	Medidas (mm)	Unds.	Código	EAN	P.V.P. (€)
DTW1001 DTW1002 DTW700 DTW701 TW001G TW007G TW008G	807 - 657x243x172 mm	1	191G67-2	0088381568302	138,00



**Porta-brocas automático - 1/4" hexagonal**



763198-1



784643-3

Inserção	Capacidade (mm)	Passo	Tipo	Código	EAN	P.V.P. (€)
1/4"hex	1,0 - 10	3/8"	Automático	763198-1	0088381256070	28,00
Adaptador	1/2"	3/8"	-	784643-3	0088381248013	5,00

**Cabo conector**



Modelos	Comp. (mm)	Qualidade	Unds.	Código	EAN	P.V.P. (€)
FS6300R	4	Padrão	1	699020-5	3240890265913	13,40
	10	Padrão	1	194330-0	0088381289863	26,00
	10	Alta	1	194906-3	0088381354066	40,00

**Anel de bloqueio para bocas de aparafusamento\***



\*necessário para todas as bocas de aparafusamento, exceto as caixas para FS2700

Unds.	Código	EAN	P.V.P. (€)
1	455591-0	-	2,00

**Punho auxiliar**

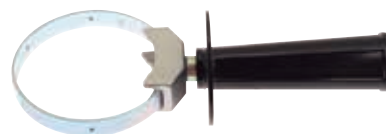

Modelo	Comp. (mm)	Unds.	Código	EAN	P.V.P. (€)
6906	110	1	122464-9	0088381152495	18,70
TW1000	110	1	122727-3	0088381199988	22,00

**Bocas de aparafusamento**



Modelos	Para	Medida	Unds.	Código	EAN	P.V.P. (€)
FS2500	Caixa	1/4"	1	450963-4	0088381365093	1,95
		5/16"	1	450967-6	0088381468633	1,30
		3/8"	1	450968-4	0088381365109	1,30
	Ponta	60 mm	1	122867-7	3240890367600	6,50
		75 mm	1	122868-5	-	7,20

Modelos	Para	Medida	Unds.	Código	EAN	P.V.P. (€)
FS2300 FS4200 FS6300R	Ponta	60 mm	1	158875-2	3240890322227	7,20
		75 mm	1	158876-0	0088381468558	7,80

Modelos	Para	Medida	Unds.	Código	EAN	P.V.P. (€)	
FS2700	Pontas 50 mm	-	1	322120-3	0088381162753	8,60	
		1/4"	1	322124-5	3240890027573	13,20	
	Pontas	5/16"	1	322125-3	-	13,80	
		Caixa	3/8"	1	322119-8	3240890083586	20,00
			7/16"	1	322126-1	-	14,90





# *Limpar e Lixar*



**Catrabuchas para berbequins**



Makita

**Catrabuchas**

**Material**



**Arame de aço ondulado**

- Recomendado para remover ferrugem, vernizes, esmaltes... de superfícies metálicas.

**Nylon grosso**

- Perfeito para limpar ferrugem, verniz, esmalte... de superfícies de metal, madeira e PVC.

**Nylon fino**

- Para um acabamento mais suave.
- Adequado para madeira, metal e PVC.

**Forma**

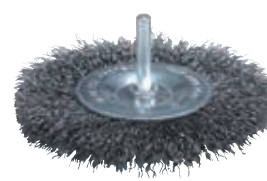

**Escovas de acabamento**

- Perfeitas para superfícies estreitas ou de difícil acesso.

**Copo ondulado**

- Ideal para a limpeza de superfícies planas ou rugosas.

**Escovas de cerdas**

- Para superfícies planas.
- Recomendadas para madeira.

**Escova oblíqua**

- Ideal para limpeza de superfícies estreitas, bordas ou ranhuras.



Arame entrançado



Arame



Arame latonado



Nylon grosso G80



Nylon fino G240

	Arame entrançado	Arame	Arame latonado	Nylon grosso G80	Nylon fino G240
Indicado para	Ideal para metal e trabalhos pesados	Ideal para metal e trabalhos leves	Ideal para metal e madeira. Arame resistente à oxidação.	Ideal para a ferrugem ligeira de metal, madeira e PVC.	Ideal para o acabamento de materiais, madeira e PVC.
Eficiência	Eficiência muito alta	Eficiência alta	Eficiência alta	Eficiência baixa	Eficiência muito baixa
Acabamento	Muito grosseiro	Grosseiro	Grosseiro	Limpo	Muito limpo
Madeira	X	X	✓	✓	✓
PVC	X	X	◆	✓	✓
Metal	✓	✓	✓	✓	✓

✓ : Recomendado    ◆ : Adequado    X : Não recomendado

## Catrabuchas para berbequins

### Escovas de acabamento de nylon

★★

- Ideal para superfícies estreitas ou de difícil acesso. Remoção de ferrugem, esmaltes, vernizes, etc., em metais, plásticos ou madeira.



Ø (mm)	Inserção (mm)	Grão	Espessura (mm)	Tipo	Unds.	Código	EAN	P.V.P. (€)
12	6	80	1,4	Nylon	1	D-45668	0088381408875	3,20
17	6	80	1,4	Nylon	1	D-45674	0088381408882	4,10
24	6	80	1,4	Nylon	1	D-45680	0088381408899	4,70
30	6	80	1,4	Nylon	1	D-45696	0088381408905	6,40
12	6	240	0,7	Nylon	1	D-45705	0088381408912	3,20
17	6	240	0,7	Nylon	1	D-45711	0088381408929	4,10
24	6	240	0,7	Nylon	1	D-45727	0088381408936	4,70
30	6	240	0,7	Nylon	1	D-45733	0088381408943	6,40

### Escovas de acabamento de arame

★★

- Muito eficazes para superfícies estreitas e de difícil acesso. Arames ondulados para tornar a superfície acabada muito mais lisa.



Ø (mm)	Inserção (mm)	Grão	Espessura (mm)	Tipo	Unds.	Código	EAN	P.V.P. (€)
12	6	-	-	Arame	1	D-40004	0088381400121	1,75
19	6	-	-	Arame	1	D-40010	0088381400138	2,05
25	6	-	-	Arame	1	D-40026	0088381400145	2,60
30	6	-	-	Arame	1	D-40032	0088381400152	2,90

### Escovas de acabamento de arame latonado

★★

- Ideais para trabalhar em superfícies estreitas e de difícil acesso.
- Mais macias, ideais para madeira.



D-73710

D-73726

D-73732

Ø (mm)	Inserção (mm)	Grão	Espessura (mm)	Tipo	Unds.	Código	EAN	P.V.P. (€)
12	6	-	-	Latonado	1	D-73704	0088381586238	1,45
19	6	-	-	Latonado	1	D-73710	0088381586245	1,65
24	6	-	-	Latonado	1	D-73726	0088381586252	2,00
28	6	-	-	Latonado	1	D-73732	0088381586269	2,25

### Escovas de arame entrançado

★★

- Ideais para superfícies estreitas e de difícil acesso. Indicadas para metal.
- Arame de aço mais grosso para trabalhos mais exigentes.



D-73835

D-73841

D-73863

Ø (mm)	Inserção (mm)	Grão	Espessura (mm)	Tipo	Unds.	Código	EAN	P.V.P. (€)
12	6	-	-	Entrançado	1	D-73835	0088381586467	2,40
19	6	-	-	Entrançado	1	D-73841	0088381586474	3,10
24	6	-	-	Entrançado	1	D-73857	0088381586481	3,60
28	6	-	-	Entrançado	1	D-73863	0088381586498	4,80



## Catrabuchas para berbequins

### Escovas de copo ondulado de nylon

★★

- Ideais para a limpeza de superfícies planas ou rugosas. Remoção de ferrugem, esmaltes, vernizes, etc., em metais, plásticos e madeira.



D-45543



D-45515

Ø (mm)	Inserção (mm)	Grão	Espessura (mm)	Tipo	Unds.	Código	EAN	P.V.P. (€)
50	6	80	1,4	Nylon	1	D-45509	0088381408714	5,20
63	6	80	1,4	Nylon	1	D-45515	0088381408721	7,00
75	6	80	1,4	Nylon	1	D-45521	0088381408738	8,10
50	6	240	0,7	Nylon	1	D-45537	0088381408745	5,20
63	6	240	0,7	Nylon	1	D-45543	0088381408752	7,00
75	6	240	0,7	Nylon	1	D-45559	0088381408769	8,10

### Escovas de copo ondulado de arame

★★

- Muito eficazes em superfícies planas ou rugosas. Arames ondulados para tornar a superfície acabada muito mais lisa.



Ø (mm)	Inserção (mm)	Grão	Espessura (mm)	Tipo	Unds.	Código	EAN	P.V.P. (€)
38	6	-	-	Arame	1	D-39908	0088381400022	2,10
50	6	-	-	Arame	1	D-39914	0088381400039	2,35
63	6	-	-	Arame	1	D-39920	0088381400046	2,60
75	6	-	-	Arame	1	D-39936	0088381400053	2,90
80	6	-	-	Arame	1	D-39942	0088381400060	3,50

### Catrabuchas de copo ondulado de arame latonado

★★

- Muito eficazes para superfícies planas. Adequadas para a remoção de ferrugem, vernizes, etc. Especialmente recomendadas para madeira.



D-73601



D-73623



D-73645

Ø (mm)	Inserção (mm)	Grão	Espessura (mm)	Tipo	Unds.	Código	EAN	P.V.P. (€)
	6	-	-	Latonado	1	D-73601	0088381586139	1,55
50	6	-	-	Latonado	1	D-73617	0088381586146	1,80
63	6	-	-	Latonado	1	D-73623	0088381586153	2,00
75	6	-	-	Latonado	1	D-73639	0088381586160	2,25
80	6	-	-	Latonado	1	D-73645	0088381586177	2,80

### Escovas de copo ondulado de arame entrançado

★★

- Muito eficazes para superfícies planas. Adequadas para a remoção de ferrugem, vernizes, etc. Especialmente recomendadas para superfícies metálicas.



D-73798



D-73807

Ø (mm)	Inserção (mm)	Grão	Espessura (mm)	Tipo	Unds.	Código	EAN	P.V.P. (€)
63	6	-	-	Entrançado	1	D-73798	0088381586429	5,00
75	6	-	-	Entrançado	1	D-73807	0088381586436	5,50

### Escovas de cerdas de nylon

★★

- Ideais para superfícies planas. Remoção de ferrugem, limpeza de áreas de soldadura, vernizes, etc.



D-45755



D-45749

Ø (mm)	Inserção (mm)	Grão	Espessura (mm)	Tipo	Unds.	Código	EAN	P.V.P. (€)
100	6	80	1,4	Nylon	1	D-45749	0088381408950	8,80
100	6	240	0,7	Nylon	1	D-45755	0088381408967	8,80

## Catrabuchas para berbequins

### Escovas oblíquas de nylon

★★

- Ideais para a limpeza de superfícies estreitas, bordas ou ranhuras. Remoção de ferrugem, esmaltes, vernizes, etc., em metais, plásticos e madeira.



Ø (mm)	Inserção (mm)	Grão	Espessura (mm)	Tipo	Unds.	Código	EAN	P.V.P. (€)
38	6	80	1,4	Nylon	1	D-45565	0088381408776	4,10
50	6	80	1,4	Nylon	1	D-45571	0088381408783	5,00
63	6	80	1,4	Nylon	1	D-45587	0088381408790	5,20
75	6	80	1,4	Nylon	1	D-45593	0088381408806	7,00
100	6	80	1,4	Nylon	1	D-45602	0088381408813	8,10
38	6	240	0,7	Nylon	1	D-45618	0088381408820	4,10
50	6	240	0,7	Nylon	1	D-45624	0088381408837	5,00
63	6	240	0,7	Nylon	1	D-45630	0088381408844	5,20
75	6	240	0,7	Nylon	1	D-45646	0088381408851	7,00
100	6	240	0,7	Nylon	1	D-45652	0088381408868	8,10

### Escovas oblíquas de arame

★★

- Muito eficazes para remover as rebarbas e a ferrugem em trabalhos finos.
- Arame ondulado para tornar a superfície acabada muito mais lisa.



Ø (mm)	Inserção (mm)	Grão	Espessura (mm)	Tipo	Unds.	Código	EAN	P.V.P. (€)
38	6	-	5	Arame	1	D-39958	0088381400077	2,05
50	6	-	7	Arame	1	D-39964	0088381400084	2,35
63	6	-	9	Arame	1	D-39970	0088381400091	2,60
75	6	-	10	Arame	1	D-39986	0088381400107	2,95
100	6	-	12	Arame	1	D-39992	0088381400114	3,20

### Escovas oblíquas de arame latonado

★★

- Muitos eficazes para lixar ranhuras, especialmente em madeira.

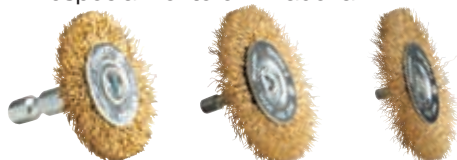

D-73651

D-73673

D-73695

Ø (mm)	Inserção (mm)	Grão	Espessura (mm)	Tipo	Unds.	Código	EAN	P.V.P. (€)
38	6	-	5	Latonado	1	D-73651	0088381586184	1,55
50	6	-	7	Latonado	1	D-73667	0088381586191	1,65
63	6	-	9	Latonado	1	D-73673	0088381586207	1,85
75	6	-	10	Latonado	1	D-73689	0088381586214	2,00
100	6	-	12	Latonado	1	D-73695	0088381586221	2,25

### Escovas oblíquas de arame entrançado

★★

- Ideais para superfícies estreitas e ranhuras principalmente de metal.



D-73813

Ø (mm)	Inserção (mm)	Grão	Espessura (mm)	Tipo	Unds.	Código	EAN	P.V.P. (€)
75	6	-	-	Entrançado	1	D-73813	0088381586443	4,80
100	6	-	-	Entrançado	1	D-73829	0088381586450	5,00

### Conjunto de catrabuchas de nylon para berbequins GROSSA (vermelho) e FINA (azul)

★★

- Inclui copo ondulado de 50 mm, escova oblíqua de 50 mm e escova de acabamento de 24 mm.



Ø (mm)	Inserção (mm)	Grão	Espessura (mm)	Tipo	Unds.	Código	EAN	P.V.P. (€)
50	6	80	1,4	Nylon	1	D-70742	0088381556033	11,10
50	6	80	1,4	Nylon	1			
24	6	80	1,4	Nylon	1			

Ø (mm)	Inserção (mm)	Grão	Espessura (mm)	Tipo	Unds.	Código	EAN	P.V.P. (€)
50	6	240	0,7	Nylon	1	D-70758	0088381556040	11,10
50	6	240	0,7	Nylon	1			
24	6	240	0,7	Nylon	1			

**Catrabuchas para rebarbadoras**

Para a limpeza antes da soldadura, oxidação e limpeza de tinta, salpicos de soldadura. Remoção da corrosão da rebarbagem, limpeza de barcos, tanques de aço, preparação de superfícies metálicas antes de pintar...



**Makita**

**Forma**



**Copo ondulado**

- Recomendado para remover ferrugem, vernizes, esmaltes... de superfícies metálicas.



**Copo ondulado entrançado**

- Arame de aço mais grosso para trabalhos mais exigentes que o tipo ondulado.
- Para superfícies mais amplas que o tipo reto.



**Copo reto ondulado entrançado**

- Para um acabamento mais suave
- Adequado para madeira, metal e PVC.



**Escova oblíqua frisada**

- Recomendada para remover ferrugem, verniz, esmalte... de superfícies metálicas em cantos ou lugares estreitos.



**Escova oblíqua trançada**

- Arame de aço mais grosso para trabalhos mais exigentes que o tipo oblíquo frisado.

Aplicação					
Madeira	X	X	◆	X	X
PVC	X	X	◆	X	X
Metal	✓	✓	✓	✓	✓

✓ : Recomendado    ◆ : Adequado    X : Não recomendado

## Catrabuchas para rebarbadoras de aço

### Copo ondulado de arame

★★



- Para superfícies planas ou rugosas. Arames ondulados para tornar a superfície acabada muito mais lisa.

Ø (mm)	Inserção (mm)	Espessura (mm)	Tipo	Unds.	Código	EAN	P.V.P. (€)
60	M14	0,3	Aço	1	D-24072	0088381313674	4,10
75	M14	0,3	Aço	1	D-24094	0088381313698	4,70
100	M14	0,3	Aço	1	D-29284	0088381345835	6,70
60	M14	0,3	Aço latonado	1	D-39746	0088381399869	4,10
75	M14	0,3	Aço latonado	1	D-39768	0088381399883	4,70
90	M14	0,3	Aço latonado	1	D-39780	0088381399906	5,80
100	M14	0,3	Aço latonado	1	D-39805	0088381399920	7,60

### Copo ondulado de arame entrançado

★★



- Para superfícies planas ou rugosas. Arame de aço mais grosso que o tipo ondulado para trabalhos mais exigentes.

Ø (mm)	Inserção (mm)	Espessura (mm)	Tipo	Unds.	Código	EAN	P.V.P. (€)
60	M14	0,5	Aço	1	D-24119	0088381313711	5,60
75	M14	0,5	Aço	1	D-24131	0088381313735	6,20

### Copo reto ondulado de arame entrançado

★★



- Para superfícies planas ou rugosas. Arame de Aço mais grosso que o tipo ondulado para trabalhos mais exigentes.

Ø (mm)	Inserção (mm)	Espessura (mm)	Tipo	Unds.	Código	EAN	P.V.P. (€)
60	M14	0,5	Aço	1	D-24153	0088381313759	7,00
100	M14	0,5	Aço	1	D-29290	0088381345842	10,20

### Escova oblíqua de arame frisado

★★



- Muito útil para limpar cantos ou lugares estreitos onde os utilizadores não conseguem chegar facilmente. Arames oblíquos para tornar a superfície acabada muito mais lisa.

Ø (mm)	Inserção (mm)	Espessura (mm)	Tipo	Unds.	Código	EAN	P.V.P. (€)
100	M14	0,3	Aço	1	D-39827	0088381399944	4,90
115	M14	0,3	Aço	1	D-39849	0088381399968	5,80

### Escova oblíqua de arame trançado

★★



- Muito útil para limpar cantos ou lugares estreitos onde os utilizadores não conseguem chegar facilmente. Arames oblíquos para tornar a superfície acabada muito mais lisa.

Ø (mm)	Inserção (mm)	Espessura (mm)	Tipo	Unds.	Código	EAN	P.V.P. (€)
100	M14	0,5	Aço	1	D-39861	0088381399982	5,60
115	M14	0,5	Aço	1	D-39883	0088381400008	5,80
115	M14	0,5	Aço	1	D-29561	0088381346726	6,40
125	M14	0,5	Aço	1	D-29577	0088381346733	8,50
150	M14	0,5	Aço	1	D-45761	0088381410328	11,10
175	M14	0,5	Aço	1	D-45777	0088381410335	14,00

**Escovas de lixa para berbequins e rebarbadoras retas**

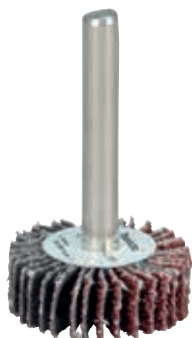

★★

• Indicados para berbequins ou rebarbadoras retas (com controlo de velocidade).



Ø (mm)	Inserção (mm)	Espessura (mm)	Altura (mm)	Unds.	Código	EAN	P.V.P. (€)
30	6	A40	10	1	D-75297	0088381594776	3,50
30	6	A60	10	1	D-75306	0088381594783	3,50
30	6	A80	10	1	D-75312	0088381594790	3,50
30	6	A120	10	1	D-75328	0088381594806	3,50
40	6	A40	20	1	D-75334	0088381594813	4,00
40	6	A60	20	1	D-75340	0088381594820	4,00
40	6	A80	20	1	D-75356	0088381594837	4,00
40	6	A120	20	1	D-75362	0088381594844	4,00
50	6	A40	20	1	D-75378	0088381594851	4,30
50	6	A60	20	1	D-75384	0088381594868	4,30
50	6	A80	20	1	D-75390	0088381594875	4,30
50	6	A120	20	1	D-75409	0088381594882	4,30
50	6	A40	30	1	D-75792	0088381597784	4,30
50	6	A60	30	1	D-75801	0088381597791	4,30
50	6	A80	30	1	D-75817	0088381597807	4,30
50	6	A120	30	1	D-75823	0088381597814	4,30
60	6	A40	30	1	D-75839	0088381597821	5,10
60	6	A60	30	1	D-75845	0088381597838	5,10
60	6	A80	30	1	D-75851	0088381597845	5,10
60	6	A120	30	1	D-75867	0088381597852	5,10

**Rolos para N9741**

**Rolo de arame de aço latonado**

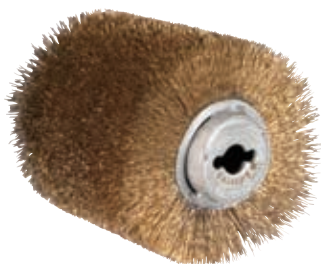

★★

**Rolo de arame de aço**



★★

Tipo	Unds.	Código	EAN	P.V.P. (€)
Aço latonado	1	D-73570	0088381586108	33,00

Tipo	Unds.	Código	EAN	P.V.P. (€)
Aço	1	D-73564	0088381586092	33,00





### Rolo de cerdas de fibra



- Para aplicação de nogalina e verniz e posterior polimento, bem como abrillanhamento natural de madeira.

Tipo	Unds.	Código	EAN	P.V.P. (€)
Fibra	1	P-04416	0088381914253	93,00

### Rolo de nylon



D-73586

P-04422



- Para a estruturar madeira macia e retocar madeira dura estruturada. Para destacar a estrutura da madeira e remover possíveis fibras de madeira. Para o pré-tratamento ideal da superfície antes da aplicação posterior de verniz e nogalina. Para realizar uma superfície retificada em aço inoxidável e alumínio.

Grão	Tipo	Qualidade	Unds.	Código	EAN	P.V.P. (€)
60	Nylon	★★★★★	1	D-73586	0088381586115	40,00
60	Nylon	★★★★★	1	P-04422	0088381914260	110,00
80	Nylon	★★★★★	1	P-04438	0088381914277	111,00
80	Nylon	★★★★★	1	794384-3	0088381139915	175,00
80	Nylon	★★★	1	D-73592	0088381586122	43,00
100	Nylon	★★★★★	1	794379-6	0088381140232	164,00
120	Nylon	★★★★★	1	P-04444	0088381914284	111,00
180	Nylon	★★★★★	1	P-04450	0088381914291	111,00
240	Nylon	★★★★★	1	794383-5	0088381139908	167,00
320	Nylon	★★★★★	1	P-04466	0088381914307	110,00

### Rolo de polimento de algodão



- Para polir superfícies, mesmo com os correspondentes cremes de polimento para aço inoxidável, latão, etc.

Tipo	Unds.	Código	EAN	P.V.P. (€)
Algodão	1	794381-9	0088381139885	208,00

### Rolo abrasivo



- Para o polimento de superfícies metálicas planas. Altamente recomendado para aço inoxidável.

Grão	Tipo	Unds.	Código	EAN	P.V.P. (€)
80	Abrasivo	1	P-18035	0088381944410	62,00
120	Abrasivo	1	P-18041	0088381944427	62,00
180	Abrasivo	1	P-18029	0088381944403	62,00

### Rolo abrasivo com lixas



- Para o polimento de superfícies metálicas planas. Altamente recomendado para aço inoxidável. Lixa e pule ao mesmo tempo.

Grão	Tipo	Unds.	Código	EAN	P.V.P. (€)
80	Abrasivo	1	P-18057	0088381944434	68,00
120	Abrasivo	1	P-19233	0088381945844	68,00
180	Abrasivo	1	P-19249	0088381945851	68,00

### Rolo de lixas



- Para polir superfícies. Raspar tinta.

Grão	Tipo	Unds.	Código	EAN	P.V.P. (€)
40	Abrasivo	1	P-01127	0088381913904	65,00
80	Abrasivo	1	P-01155	0088381921596	65,00



**Lâminas HM&HSS** ★★

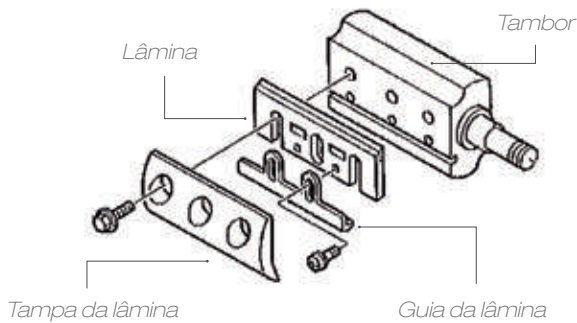

Modelo	Tipo	Comp. (mm)	Unds.	Código	EAN	P.V.P. (€)
1100 DKP180 DKP181 KP0800 KP0810 KP0810C	HSS	82	2	D-16346	0088381187756	7,30
	HM	82	2	D-07967	0088381181624	15,70
1911B	HSS	110	2	D-71211	0088381560160	15,30
	HSS	170	2	D-63666	0088381524070	27,00



**Conjunto de mini lâminas + lâminas HM/chapas** ★★

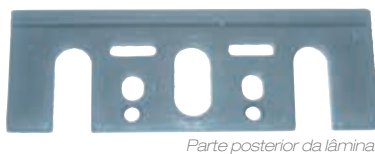

Modelos	Comp. (mm)	Detalhe	Unds.	Código	EAN	P.V.P. (€)
1100 DKP180 DKP181 KP0800 KP0810 KP0810C	82	2+2	1	D-07951	0088381181617	13,30

**Chapa para mini lâminas**



Modelos	Comp. (mm)	Unds.	Código	EAN	P.V.P. (€)
1100 DKP180 DKP181 KP0800 KP0810 KP0810C	82	1	343433-9	0088381151115	3,90

**Mini lâminas**

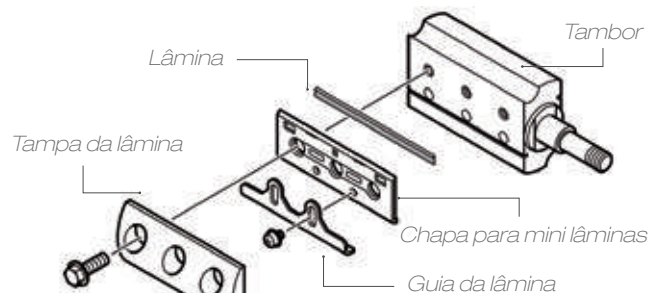

Modelo	Tipo	Comp. (mm)	Unds.	Código	EAN	P.V.P. (€)	
1050D 1051D	HM	50	2	A-85400	0088381148337	11,00	★★★
1100 DKP180 DKP181 KP0800 KP0810 KP0810C	HM	82	2	D-07945	0088381181600	11,90	★★
2012NB	HSS	304	2	793346-8	0088381101042	42,00	★★★
KP312S	HSS	312	2	B-02870	0088381125840	39,00	★★★

**Conjunto de mini lâminas 82mm** ★★

- Embalagem com 5 pacotes de 2 unidades de mini lâminas código D-07945. Os jogos podem ser facilmente separados para a venda individual de cada um deles.
- Adequado para plainas de 82 mm.



Comp. (mm)	Tipo	Unds.	Código	EAN	P.V.P. (€)
82	HM	5	D-35302	0088381367646	44,00

## Guias paralelas



Tipo A

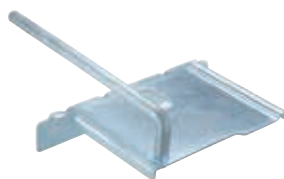

Tipo B



Tipo C

Modelo	Tipo	Unds.	Código	EAN	P.V.P. (€)
1100	A	1	161046-2	0088381122962	27,00
1902 1923B 1923H	B	1	165581-2	0088381361415	6,30
KP0800 DKP180	B	1	195055-9	0088381367110	10,60
KP0810 / C DKP181	C	1	122785-9	0088381346023	7,90
	C	1	191C23-8	0088381557429	31,00



## Guia de profundidade



Modelos	Unds.	Código	EAN	P.V.P. (€)
KP0810 KP0810C KP0800 1923B 1923H	1	342390-8	0088381346412	2,20

## Guia de chanfrar



Podem colocar-se duas guias de chanfrar.

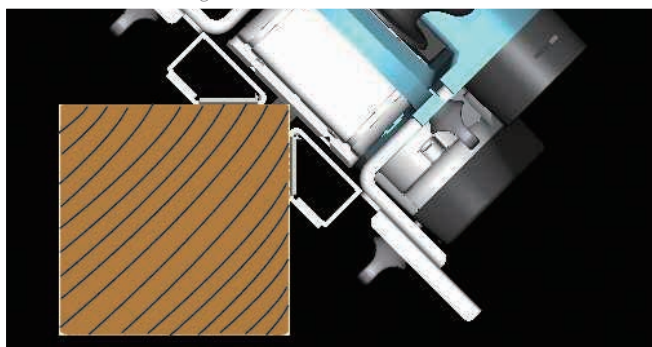

Modelos	Unds.	Código	EAN	P.V.P. (€)
KP0810 KP0810C	1	122791-4	0088381343190	29,00
DKP181	2	191C22-0	0088381557405	87,00

## Extensão para guias

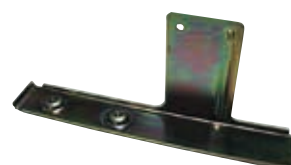

Modelos	Unds.	Código	EAN	P.V.P. (€)
1923B 1923H KP0800 DKP180	1	191725-8	0088381126946	14,30

## Mesa



Modelos	Unds.	Código	EAN	P.V.P. (€)
2012NB	1	193902-8	0088381186421	75,00

## Adaptador de aspiração



Modelo	Diâmetro de saída	Unds.	Código	EAN	P.V.P. (€)
2012NB	76 mm	1	193036-7	0088381154390	29,00



### Calibrador de lâminas



Modelos	Unds.	Código	EAN	P.V.P. (€)
1100 1923B KP0800 KP0810/C DKP180 DKP181	1	123062-2	0088381111270	3,05

### Pedra de afiar

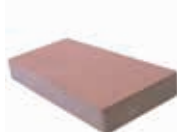

Comprimento total (mm)	Unds.	Código	EAN	P.V.P. (€)
150	1	794061-7	0088381110174	11,60
180	1	794060-9	0088381103176	13,80

### Chave hexagonal



Forma	mm	Unds.	Código	EAN	P.V.P. (€)
L	4,0	1	783202-0	0088381102667	1,10
T	4,0	1	783230-5	0088381367158	2,80
L	2,5	1	783208-8	0088381152624	1,10

### Chave de tubo 9



Modelos	Unds.	Código	EAN	P.V.P. (€)
1100 KP0800 1923B KP312S KP0810/C	1	782209-3	0088381102568	2,25

### Chave fixa de 8 mm



Modelo	Unds.	Código	EAN	P.V.P. (€)
KP301	1	781213-9	0088381102520	2,20

### Suporte de afiação

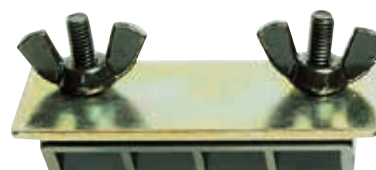

Modelos	Unds.	Código	EAN	P.V.P. (€)
1100 1923B KP0800 KP0810/C DKP180 DKP181	1	123004-6	0088381115391	3,30

### Saco de pó



Modelos	Unds.	Código	EAN	P.V.P. (€)
2012NB	1	STEX122312	0088381114974	68,00
KP0800 KP0810/C	1	122793-0	0088381346030	18,20
DKP181	1	191C21-2	0088381557450	31,00

### Defletor de aparas



Modelos	Unds.	Código	EAN	P.V.P. (€)
1923H	1	122354-6	0088381114936	15,40
1100	1	415452-6	0088381142717	3,70
KP301	1	H311225	3240890101976	70,00
KP0800 KP0810/C	1	416368-8	0088381141703	2,20

### Esquadro



Modelos	Unds.	Código	EAN	P.V.P. (€)
1806B 1923H KP312S	1	762001-3	0088381156912	0,85

# Diamante



**Protetores de disco para rebarbadoras.  
Trabalhe *sem pó*. Cuide da sua *saúde*.**



Discos de diamante

**QUASAR**



Discos de alta qualidade para todas as aplicações profissionais com tecnologia de posicionamento de diamantes 3DDG.

Tecnologia STEALTH que utiliza 2 discos que fazem de molde sobre um núcleo de aço temperado para reduzir tanto a vibração como o ruído. Cortes mais limpos e mais rápidos.

**STEALTH TECHNOLOGY**

**30% MAIS DURAÇÃO**

**50% MAIS RÁPIDO**



A altura dos segmentos é aumentada até 12 mm.



Os dentes em forma de M permitem um bom início do corte.

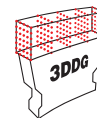

A tecnologia 3D DiamondGrid é um método avançado de fabrico do segmento que ordena os grãos de diamante de forma paralela e uniforme em todo o segmento.

Soldadura a laser que resiste a altas temperaturas.



Discos de diamante Quasar

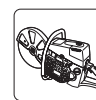
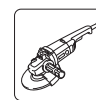
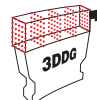

Betão



Mármore Mosaico



Tijolo médio/duro



Telha cerâmica



Ardozia macia

- Quasar com corpo compacto, mais silencioso, soldado a laser, banda segmentada, baixa vibração, longa duração e tecnologia STEALTH.

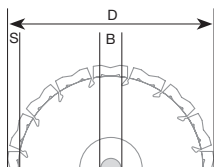

D (mm)	B (mm)	Redução (mm)	S (mm)	Especificações	Unds.	Código	EAN	P.V.P. (€)
230	22,23	-	12	3DDG Stealth.	1	B-12712	0088381355452	148,00
300	20	-	12		1	B-13459	0088381359160	214,00
350	25,4	20	12		1	B-13465	0088381359177	276,00
400	25,4	20	12		1	B-13471	0088381359184	330,00



**Discos de diamante**



**30% MAIS DURAÇÃO**

**50% MAIS RÁPIDO**

Aberturas de refrigeração para manter a lâmina bem refrigerada durante o corte.

Soldadura a laser que resiste a altas temperaturas.

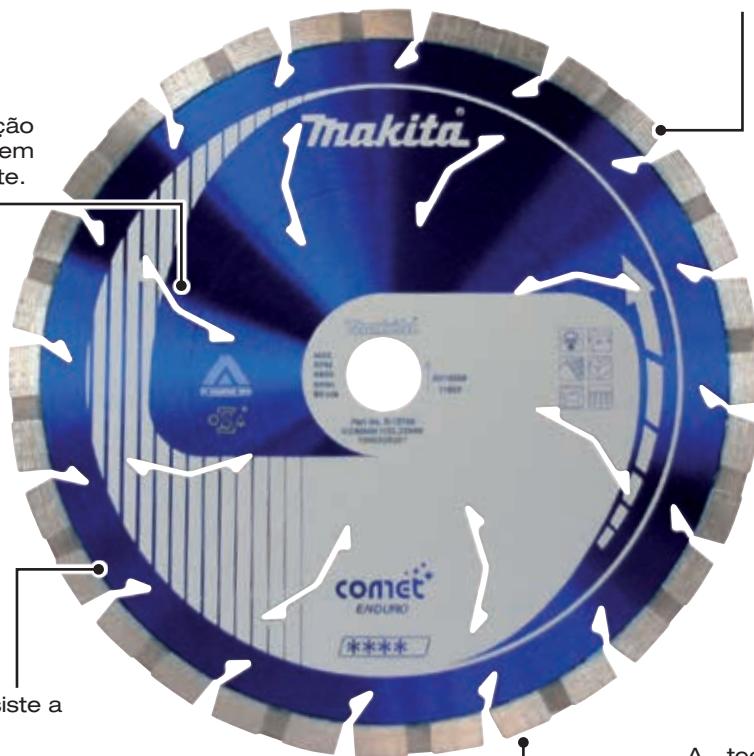

A altura dos segmentos é aumentada até 10 mm.



Dentes com recesso no centro para facilitar a refrigeração.

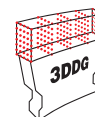

A tecnologia 3D DiamondGrid é um método avançado de fabrico do segmento que ordena os grãos de diamante de forma paralela e uniforme em todo o segmento.

**Discos de diamante COMET**



- Corpo compacto, mais silencioso.
- Soldado a laser.
- Baixa vibração.

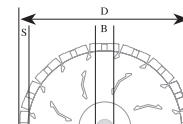
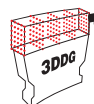

D (mm)	B (mm)	Redução (mm)	S (mm)	Especificações	Unds.	Código	EAN	P.V.P. (€)
115	22,23	-	10	Aberturas de refrigeração	1	B-12762	0088381355506	48,00
125	22,23	20	10		1	B-12778	0088381355513	49,00
230	22,23	-	10	3DDG Aberturas de refrigeração Centro reforçado	1	B-12784	0088381355520	111,00
300	20	-	10		1	B-13546	0088381359252	166,00
350	25,4	20	10		1	B-13552	0088381359269	197,00
400	25,4	20	10		1	B-13568	0088381359276	238,00



**Discos de diamante COMET banda turbo**



- Disco com banda turbo para obter um bom acabamento da peça de trabalho.
- Aberturas de refrigeração que evitam dilatações no disco.
- Soldado a laser para resistir a altas temperaturas.



Mármore Mosaico



Tijolo duro



Granito



Tijolo macio



Ardósia macia

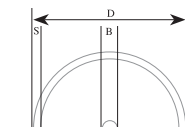

D (mm)	B (mm)	Redução (mm)	S (mm)	Especificações	Unds.	Código	EAN	P.V.P. (€)
115	22,23	-	7	Banda turbo Núcleo padrão	1	B-12980	0088381358170	44,00
125	22,23	20	7		1	B-12996	0088381358187	49,00
150	22,23	20	7		1	B-13007	0088381358194	60,00
230	22,23	-	8		1	B-13035	0088381358224	97,00
300	25,4	-	8,5		1	B-13041	0088381358231	180,00
350	25,4	-	8,5		1	B-13057	0088381358248	235,00

**Discos de diamante COMET banda contínua**



- Acabamento perfeito nos materiais mais duros.
- É recomendado trabalhar com água para uma boa refrigeração.
- Soldado a laser para resistir a altas temperaturas.



Azulejo cerâmico porcelânico

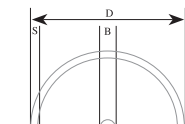

D (mm)	B (mm)	Redução (mm)	S (mm)	Especificações	Unds.	Código	EAN	P.V.P. (€)
80	15	-	5	Banda contínua Núcleo padrão	1	B-13063	0088381358255	76,00
115	22,23	-	5		1	B-13085	0088381358279	29,00
125	22,23	-	5		1	B-13091	0088381358286	31,00

**Discos de diamante COMET banda contínua electrodepositada**



- Disco de banda contínua com diamante electrodepositado especial para materiais muito compactos e que requerem um corte muito limpo para evitar ruturas.



GRP



Mármore Mosaico



Painel de fibras



Fibra de vidro

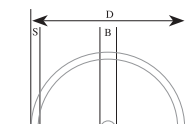

D (mm)	B (mm)	Redução (mm)	S (mm)	Especificações	Unds.	Código	EAN	P.V.P. (€)
115	22,23	-	-	Electrodepositado Núcleo padrão	1	B-13172	0088381358378	58,00
125	22,23	20	-		1	B-13188	0088381358385	59,00
150	22,23	20	-		1	B-13194	0088381358392	79,00
230	22,23	-	-		1	B-13219	0088381358415	154,00
250	22,23	-	-		1	B-13225	0088381358422	281,00

**Discos de diamante COMET especial juntas**



- Design perfeito para uso em argamassa, bem como em materiais muito abrasivos.
- Para uso em argamassa e tijolo macio.
- Aberturas de refrigeração grandes.

• **Espessura 6,5mm**

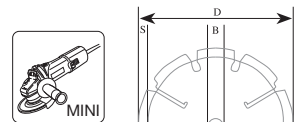
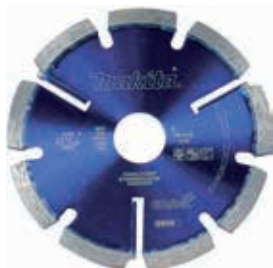

D (mm)	B (mm)	Redução (mm)	S (mm)	Especificações	Unds.	Código	EAN	P.V.P. (€)
125	22,23	-	6,5	-	1	B-13253	0088381358453	103,00

**Discos de diamante COMET especial asfalto**



- Disco especial para trabalhar em asfalto.
- Disco com pastilha de diamante de grande dureza, pois o asfalto é muito abrasivo.
- Banda segmentada para a sua refrigeração, mas é recomendado usar com cortadores de gasolina com refrigeração a água para uma boa duração do disco.

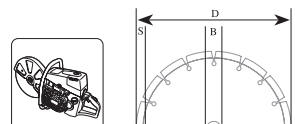

D (mm)	B (mm)	Redução (mm)	S (mm)	Especificações	Unds.	Código	EAN	P.V.P. (€)
300	20	-	10	Asfalto Núcleo padrão	1	B-13269	0088381358460	185,00
350	25,4	20	10		1	B-13275	0088381358477	216,00

**Discos de diamante NEBULA**



- Discos de diamante de qualidade padrão.
- Pro Segment/Laser Welding: reduz o sobreaquecimento e oferece uma vida útil mais longa.
- Para cortar betão, betão armado, tijolo, pedra calcária e arenito.

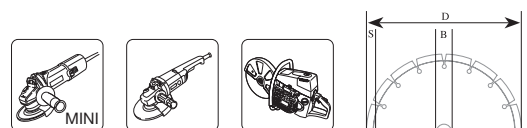

D (mm)	B (mm)	Redução (mm)	S (mm)	Especificações	Unds.	Código	EAN	P.V.P. (€)
115	22,23	-	10	Soldadura a laser	1	B-53986	0088381476485	25,00
125	22,23	-	10		1	B-53992	0088381476492	27,00
230	22,23	-	10		1	B-54025	0088381476522	35,00
300	20	-	10		1	B-54031	0088381476539	110,00
350	25,4	20	10		1	B-54053	0088381476553	79,00
400	25,4	20	10		1	B-54069	0088381476560	102,00



- **Discos de uso geral para o corte de todos os tipos de material de construção.**
- **Adequado para materiais de alvenaria.**

**Discos de diamante DIAMAK banda segmentada**

- Gama económica de discos para trabalhos gerais de obra. Pode ser utilizado tanto em cortes secos como molhados. Disponíveis com banda segmentada, turbo e banda contínua.
- Todos os tipos de alvenaria, bloco, tijolo, ardósia e pedra calcária.

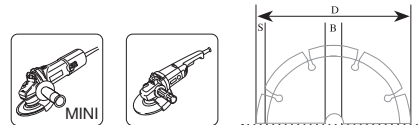

D (mm)	B (mm)	Redução (mm)	S (mm)	Especificações	Unds.	Código	EAN	P.V.P. (€)
115	22,23	-	7	Banda segmentada Núcleo padrão	1	D-61123	0088381475778	8,70
125	22,23	-	7		1	D-52766	0088381445177	8,70
150	22,23	-	7		1	B-06432	0088381276122	22,00
230	22,23	-	7		1	D-61145	0088381475792	18,70
300	25,40	-	7,5		1	D-56982	0088381458085	67,00
350	25,40	-	7,5		1	D-56998	0088381458092	83,00
400	25,40	-	7,5		1	D-57009	0088381458108	97,00



- **Novo** expositor de cartão. Inclui 10 unds.

125	22,23	-	7	Banda segmentada Núcleo padrão	10	D-41595-10	0088381435376	88,00
-----	-------	---	---	-----------------------------------	----	------------	---------------	-------

**Discos de diamante DIAMAK banda turbo**

- Para materiais duros, granito, materiais argilosos, ardósia, pedra calcária e betão duro.
- Banda segmentada.
- Núcleo padrão.

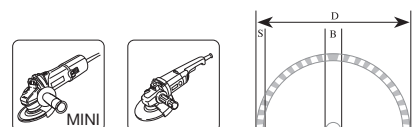

D (mm)	B (mm)	Redução (mm)	S (mm)	Especificações	Unds.	Código	EAN	P.V.P. (€)
115	22,23	-	7	Banda segmentada Núcleo padrão	1	D-61151	0088381475808	8,70
125	22,23	20	7		1	D-61167	0088381475815	10,00
230	22,23	-	7		1	D-61173	0088381475822	22,00

**Discos de diamante DIAMAK banda contínua**

- Para materiais duros, granito, materiais argilosos, ardósia, pedra calcária e betão duro.

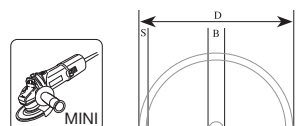

D (mm)	B (mm)	Redução (mm)	S (mm)	Especificações	Unds.	Código	EAN	P.V.P. (€)
110	22,23	-	7	Banda contínua Núcleo padrão	1	D-61189	0088381475839	7,50

**Disco de diamante especial para ferramentas a bateria**



- Novo disco de diamante de 230 mm ideal para cortadores a bateria.
- Com este disco aumentamos a velocidade de corte e a vida útil do mesmo.
- Para conseguir ranhuras mais estreitas, desenhamos o segmento em forma de leque, obtendo um melhor desempenho de trabalho. Os diamantes são distribuídos uniformemente na estrutura do segmento, alcançando assim um desempenho de trabalho estável e reduzindo o consumo de bateria.

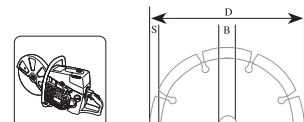

D (mm)	B (mm)	Redução (mm)	S (mm)	Especificações	Unds.	Código	EAN	P.V.P. (€)
230	22,23	-	7	especial para DCE090	1	E-02967	0088381475792	149,00
355	25,4	-	8	CE001	1	E-12996	0088381590099	166,00



**Discos de diamante X-LOCK**



- Disco de diamante segmentado X-LOCK 115 x 22,23 mm.
- Os discos de diamante compatíveis com as rebarbadoras X-LOCK permitem uma instalação fácil e segura do disco.

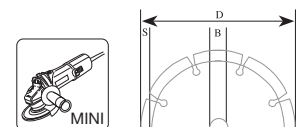

D (mm)	B (mm)	Redução (mm)	S (mm)	Especificações	Unds.	Código	EAN	P.V.P. (€)
115	22,23	-	7	Compatível com rebarbadoras X-LOCK	1	E-02060	0088381556217	40,00
125	22,23	-	7		1	E-02076	0088381556224	43,00



**Discos de diamante especial vidro e porcelana**



- Segmentos contínuos para um corte limpo sem quebrar as arestas de corte de azulejos, cerâmica, mármore, vidro, etc.



D (mm)	B (mm)	Modelo	Unds.	Código	EAN	P.V.P. (€)
85	15	CC301D	1	B-21098	0088381399777	37,00



- Segmento contínuo e inclinado com uma largura extrafina de 1,2 mm para o corte rápido e limpo de azulejos, mármore e vidro.



D (mm)	B (mm)	Modelo	Unds.	Código	EAN	P.V.P. (€)
110	20	4101RH	1	B-22028	0088381401760	101,00



- Acabamento perfeito nos materiais mais duros. É recomendado trabalhar com água para uma boa refrigeração. Soldado a laser para resistir a altas temperaturas. Indicado para betão e porcelana (não para vidro).



D (mm)	B (mm)	Modelo	Unds.	Código	EAN	P.V.P. (€)
125	20	4101RH	1	B-21951	0088381401692	40,00



- Especial para porcelana.
- Disco extrafino, ideal para máquinas a bateria.
- 1,4 mm.



D (mm)	B (mm)	Modelo	Unds.	Código	EAN	P.V.P. (€)
115	22,23	Rebarbadoras 115 mm	1	B-46327	0088381452403	39,00



- Especial para porcelana.
- Disco extrafino, ideal para máquinas a bateria.
- 1,4 mm.



D (mm)	B (mm)	Modelo	Unds.	Código	EAN	P.V.P. (€)
125	22,23	Rebarbadoras 125 mm	1	B-46333	0088381452410	42,00



**Discos de diamante especial resgate multimaterial**



B-55326

- Corta todo o tipo de materiais: Metal, plástico, madeira, vidro, tijolo, fibrocimento, betão...
- Perfeito para operações de resgate.
- Muito utilizado em quartéis de bombeiros.

D (mm)	B (mm)	Modelo	Unds.	Código	EAN	P.V.P. (€)
125	22,23	Rebarbadoras 125 mm	1	B-55310	0088381482035	56,00
230	22,23	Rebarbadoras 230 mm	1	B-55326	0088381482042	104,00
305	22,23	Rebarbadoras 305 mm	1	B-55332	0088381482059	187,00



**Discos de diamante para polir betão**



B-12289

- Disco para limpar e polir superfícies de betão e pedra natural com um acabamento fino.



B-12295

- Disco para limpar rapidamente camadas grossas de betão.

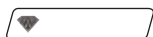

D-41464

- Gama económica.
- Disco para limpar e polir superfícies de betão e pedra natural com um acabamento fino.



D-41458

- Gama económica.
- Disco para limpar rapidamente camadas grossas de betão.

D (mm)	B (mm)	Modelo	Unds.	Código	EAN	P.V.P. (€)
125	22,23	PC5010C	1	B-12289	0088381354042	225,00
125	22,23	PC5010C	1	B-12295	0088381354059	110,00
125	22,23	PC5010C	1	D-41464	0088381404280	66,00
125	22,23	PC5010C	1	D-41458	0088381404273	58,00



**Corte a seco - DBM130**

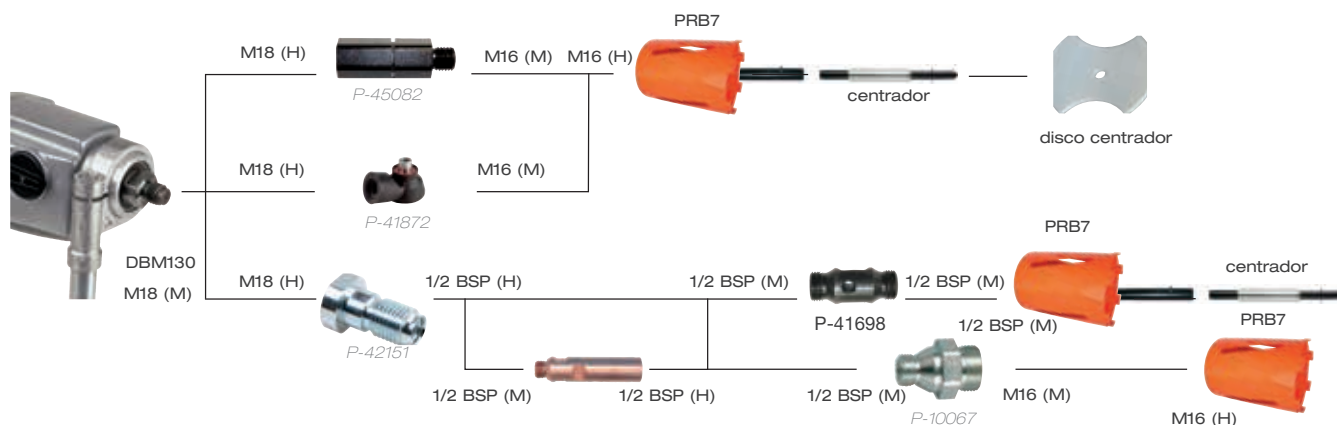

**Brocas de coroa de diamante para seco PRB7**

- Brocas de diamante para todo o tipo de alvenaria.
- Para utilizar com martelos SDS-PLUS.

**Brocas de coroa de diamante para seco DB4**

- Brocas de diamante para granito, mármore, tijolo duro e outros materiais abrasivos.

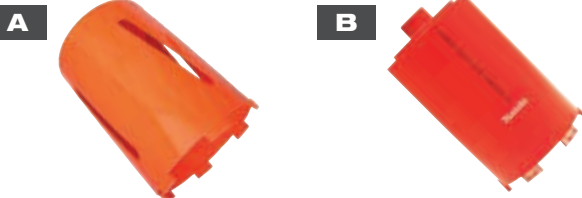

Tipo	Ø (mm)	Comp. (mm)	Inserção	Unds.	Código	EAN	P.V.P. (€)
A	22	300	1/2BSP (H)	1	P-57102	0088381987622	72,00
	28	300		1	P-57118	0088381987639	74,00
	32	150		1	P-57124	0088381987646	74,00
	38	150		1	P-57146	0088381987660	74,00
	48	150		1	P-57152	0088381987677	75,00
	65	150		1	P-57174	0088381987691	77,00
B	68	150	M16 (H)	1	P-63806	0088381994323	104,00

Ø (mm)	Comp. (mm)	Inserção	Unds.	Código	EAN	P.V.P. (€)
22	300	1/2BSP (H)	1	P-64060	0088381994583	42,00
28	300		1	P-64076	0088381994590	44,00
32	150		1	P-64082	0088381994606	46,00
38	150		1	P-64098	0088381994613	46,00
48	150		1	P-64107	0088381994620	50,00
52	150		1	P-64113	0088381994637	51,00
65	150		1	P-64129	0088381994644	52,00

- Para utilização com martelos SDS-PLUS, incluir adaptador de broca de diamante página 169.

**Prolongadores para brocas de coroa**



Comp. (mm)	Inserção	Unds.	Código	EAN	P.V.P. (€)
100	5/4 UNC	1	P-41604	0088381968614	45,00
200		1	P-41610	0088381968621	42,00
300		1	P-41626	0088381968638	52,00
500		1	P-41648	0088381968652	85,00
100	1/2 BSP	1	P-41551	0088381968560	45,00
300		1	P-34718	0088381963879	26,00





### Centradores



Tipo	Medida	Unds.	Código	EAN	P.V.P. (€)
A	60 (ponta)	1	P-41888	0088381968294	27,00
B	340 (para ponta)	1	P-41903	0088381968317	79,00
C	170	1	P-34724	0088381963886	18,70

### Adaptadores para berbequins de diamante



Máquina	Broca	Unds.	Código	EAN	P.V.P. (€)
5/4 UNC (F)	1/2 BSP (F)	1	P-41676	0088381968683	52,00
1/2 BSP (M)	5/4 UNC (M)	1	P-41682	0088381968690	51,00
1/2 BSP (M)	1/2 BSP (M)	1	P-41698	0088381968706	42,00
1/2 BSP (M)	M16(M)	1	P-10067	0088381931083	16,80
1/2 BSP (M)	M30(M)	1	P-10073	0088381931090	17,70
HI	1/2 BSP (F)	1	P-41707	0088381968713	48,00
M18(F) - 5/4 UNC (M)	1/2 BSP (F)	1	P-42151	0088381970020	35,00
M18(F)	M30(M)	1	P-41866	0088381968270	20,00
M18(F)	M16(M)	1	P-45082	0088381975193	37,00
SDS-PLUS	1/2 BSP (M)	1	P-30031	0088381958196	22,00
SDS-PLUS	M16(M)	1	P-67745	0088381998277	22,00

### Disco centrador (para utilizar com centrador)



Medida	Unds.	Código	EAN	P.V.P. (€)
68	1	P-41919	0088381968324	3,60
82	1	P-41931	0088381968348	5,20
132	1	P-41981	0088381968393	11,60

### Adaptador de aspiração



\* Para funcionamento a seco com o DBM130 ou DBM131.

Rosca (máquina)	Rosca (broca)	Unds.	Código	EAN	P.V.P. (€)
De M18 x 2,5	M16x2,0	1	P-41872	0088381968287	143,00

### Brocas de coroa para rebarbadora (especial mármore)



- Perfuração mais rápida.
- Fácil obtenção do ponto de perfuração através da inclinação da máquina.
- Indicadas para trabalhar em mármore e granito.
- Utilizar apenas a seco.

Ø (mm)	Medida	Unds.	Código	EAN	P.V.P. (€)
25	M14	1	D-35025	-	23,00
30	M14	1	D-35019	-	27,00
35	M14	1	D-35003	0088381360272	28,00

### Brocas especiais para rebarbadora (especial porcelana)



D-44507

D-61070

Ø (mm)	Medida	Unds.	Código	EAN	P.V.P. (€)
6	M14	1	D-61070	0088381475532	18,60
8	M14	1	D-61086	0088381475549	19,20
10	M14	1	D-61092	0088381475556	20,00
12	M14	1	D-61101	0088381475563	28,00
14	M14	1	D-44432	0088381406758	39,00
20	M14	1	D-44454	0088381406772	30,00
25	M14	1	D-44476	0088381406796	37,00
32	M14	1	D-44507	0088381406826	47,00
38	M14	1	D-44529	0088381406840	59,00
60	M14	1	D-44585	0088381406901	82,00
65	M14	1	D-44591	0088381406918	89,00
68	M14	1	D-44616	0088381406932	94,00
75	M14	1	D-44638	0088381406956	104,00

NOVIDADE

### Kit de recuperação de água e de vácuo

[1] apenas membrana



P-54178

P-54221

Descrição	Unds.	Código	EAN	P.V.P. (€)
[1] Membrana	1	P-54184	0088381984690	30,00
Kit de recuperação de água	1	P-54178	0088381984683	210,00
Kit de fixação de vácuo	1	P-54221	0088381984737	104,00

**Suporte para DBM131 e DBM130**



Descrição	Unds.	Código	EAN	P.V.P. (€)
Suporte	1	P-40082	0088381967952	771,00

**Suporte para DBM230**



\*Kit de ancoragem igual ao DBM131.

Descrição	Unds.	Código	EAN	P.V.P. (€)
Suporte	1	P-54190	0088381984706	1.417,00

**Kit de ancoragem para DBM131, DBM130 e DBM230**

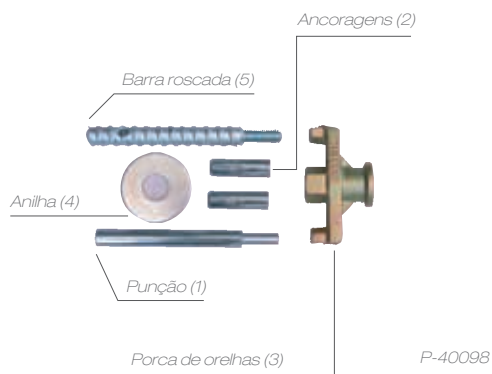

Descrição	Unds.	Código	EAN	P.V.P. (€)
Kit de fixação	1	P-40098	0088381967969	37,00
Punção (1)	1	P-40288	0088381968157	13,20
Ancoragens (2)	1	P-40107	0088381967976	1,95
Porca de orelhas (3)	1	P-40113	0088381967983	10,20
Anilha (4)	1	P-40129	0088381967990	4,70
Barra roscada (5)	1	P-41735	0088381968744	13,20

**Acessórios para PW5000CH**



**Discos de polir de diamante**



- Discos de polir de 100 mm para um polimento perfeito da pedra.
- Fixação à base através de velcro.

Grão	Ø (mm)	Tipo	Cor	Unds.	Código	EAN	P.V.P. (€)
50	100	Velcro	Azul	1	D-15584	0088381186759	15,90
200			Laranja	1	D-15609	0088381186773	15,90
800			Verde escuro	1	D-15621	0088381186797	15,90
3.000			Castanho	1	D-15643	0088381186810	15,90
PELE			Verde	1	D-15659	0088381186827	26,00

**Prato de velcro**



Ø (mm)	Tipo	Unds.	Código	EAN	P.V.P. (€)
100	Velcro	1	743080-0	0088381201223	27,00

# Abrasivo - Rebarbadoras



# Alto Rendimento Comparável a um modelo elétrico



Equipadas com controlo automático de velocidade

## ADT

Altera automaticamente a velocidade de corte para corresponder à carga de trabalho para um funcionamento ótimo.

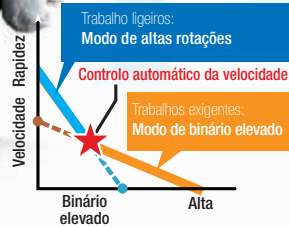

Função inteligente para minimizar o recuo

## AFT

Desliga a ferramenta para proteger o utilizador se a velocidade de rotação descer repentinamente (por exemplo, kick-back).

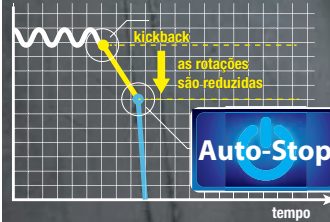

## XLOCK

Novos discos para mini rebarbadoras 18V 115/125 mm com sistema XLOCK. Permite trocar o disco rapidamente, sem ferramentas e sem esforço.



## XGT

Modelos			R.P.M.	Gatilho	AWS	BL MOTOR	AFT	ADT	XPT	BRAKE	SAR	XLOCK
115mm	125mm	150mm										
-	GA005G	GA035G	8.500	Interruptor	-	✓	✓	-	✓	✓	✓	-
-	GA013G	GA036G	8.500	Alavanca	-	✓	✓	-	✓	✓	✓	-
GA022G	GA023G	-	3.000-8.500	Interruptor	✓	✓	✓	-	✓	✓	✓	-
GA028G	GA029G	-	3.000-8.500	Alavanca	✓	✓	✓	-	✓	✓	✓	-
-	GA041G GA044G	-	3.000-8.500	Interruptor	✓	✓	✓	-	✓	✓	✓	✓

## LXT

Ultra-Ion EXTREMA TECHNOLOGIA

Modelos			R.P.M.	Gatilho	AWS	BL MOTOR	AFT	ADT	XPT	BRAKE	SAR	XLOCK
115mm	125mm	150mm										
DGA463	DGA513	-	3.000-8.500	Interruptor	-	✓	✓	✓	✓	✓	✓	-
DGA461	DGA511	-	3.000-8.500	Interruptor	-	✓	✓	✓	✓	-	✓	-
DGA454	DGA504	-	8.500	Interruptor	-	✓	✓	✓	✓	-	✓	-
DGA452	-	-	11.000	Interruptor	-	-	-	-	-	-	✓	-
-	DGA518	-	3.000-8.500	Alavanca	✓	✓	✓	✓	✓	✓	✓	-
DGA467	DGA517	-	3.000-8.500	Alavanca	-	✓	✓	✓	✓	✓	✓	-
DGA469	DGA519	-	3.000-8.500	Alavanca	-	✓	✓	✓	✓	✓	✓	✓
DGA458	DGA508	-	8.500	Alavanca	-	✓	✓	✓	✓	✓	✓	-

**Discos abrasivos de rebarbar** ★★★★★



Material	Ø ext. (mm)	Ø int. (mm)	Espessura (mm)	Unds.	Código	EAN	P.V.P. (€)
Metal	115	22,23	6,4	1	P-52978	0088381983488	1,65
Metal	125	22,23	6,4	1	P-52984	0088381983495	1,95
Metal	150	22,23	6,4	1	P-52990	0088381983501	2,80
Metal	180	22,23	7	1	P-52227	0088381982733	3,30
Metal	230	22,23	7	1	P-52819	0088381983327	4,70



**Discos abrasivos de rebarbar** ★★



Material	Ø ext. (mm)	Ø int. (mm)	Espessura (mm)	Unds.	Código	EAN	P.V.P. (€)
Metal	115	22,23	6	20	D-18459-20	0088381583992	27,00
Metal	125	22,23	6	20	D-18465-20	0088381584005	32,00

**Discos abrasivos de rebarbar** ★



Material	Ø ext. (mm)	Ø int. (mm)	Espessura (mm)	Unds.	Código	EAN	P.V.P. (€)
Metal	115	22,23	6	1	D-74485	0088381587709	1,05
Metal	125	22,23	6	1	D-74491	0088381587716	1,35
Metal	230	22,23	6	1	D-74522	0088381587747	3,20

**Discos abrasivos de rebarbar para metal especial industria pesada** ★★★★★



Material	Ø ext. (mm)	Ø int. (mm)	Espessura (mm)	Unds.	Código	EAN	P.V.P. (€)
Inox	115	22,23	7,2	1	B-56378	0088381490061	3,90
Inox	125	22,23	7,2	1	B-56390	0088381490085	4,40

**Discos abrasivos de corte**



Material	Ø ext. (mm)	Ø int. (mm)	Espessura (mm)	Unds.	Código	EAN	P.V.P. (€)
Metal <b>A</b>	115	22,23	3,2	1	P-52174	0088381982689	1,20
	125	22,23	3,2	1	P-52180	0088381982696	1,40
	150	22,23	3,2	1	P-52928	0088381983433	1,95
	180	22,23	3,2	1	P-52934	0088381983440	1,95
	230	22,23	3,2	1	P-52196	0088381982702	2,55
Pedra <b>B</b>	115	22,23	3,2	1	P-52205	0088381982719	1,40
	125	22,23	3,2	1	P-52940	0088381983457	1,65
	180	22,23	3,2	1	P-52962	0088381983471	2,20
	230	22,23	3,2	1	P-52211	0088381982726	3,05
Metal <b>C</b>	300	25,4	3	1	P-53148	0088381983655	4,10
	350	25,4	3	1	P-53154	0088381983662	5,50
	400	20	4	1	724409-9	-	46,00
Pedra <b>D</b>	300	20	3,2	1	721710-3	-	16,50
	350	25,4	4	1	721715A3	-	25,00
	400	20	4,7	1	724406-5	-	46,00



**Discos abrasivos de rebarbar**

**XLOCK**



★★★

Material	Ø ext. (mm)	Ø int. (mm)	Espessura (mm)	Unds.	Código	EAN	P.V.P. (€)
Metal	115	22,23	6	1	E-00365	0088381555395	1,85
Metal	125	22,23	6	1	E-00393	0088381555425	2,20
Inox	115	22,23	6	1	E-00371	0088381555401	2,40
Inox	125	22,23	6	1	E-00402	0088381555432	3,00

**Discos abrasivos de corte extrafinos**

**XLOCK**



★★★

Material	Ø ext. (mm)	Ø int. (mm)	Espessura (mm)	Unds.	Código	EAN	P.V.P. (€)
Metal	115	22,23	1,2	1	E-00387	0088381555418	2,00
Metal	125	22,23	1,2	1	E-00418	0088381555449	3,00

**Discos abrasivos de corte extrafinos**

**A** **B** **C** **D** ★★★

Material	Ø ext. (mm)	Ø int. (mm)	Espessura (mm)	Unds.	Código	EAN	P.V.P. (€)
Metal <b>A</b>	115	22,23	1	1	P-53001	0088381983518	1,40
	115	22,23	1,6	1	P-53017	0088381983525	1,40
	125	22,23	1	1	P-53023	0088381983532	1,45
	125	22,23	1,6	1	P-53039	0088381983549	1,45
	230	22,23	2	1	P-52233	0088381982740	3,30
Inox <b>B</b>	115	22,23	1	1	P-52249	0088381982757	1,40
	115	22,23	1,6	1	P-52255	0088381982764	1,40
	125	22,23	1	1	P-53045	0088381983556	1,40
	125	22,23	1,6	1	P-53051	0088381983563	1,45
Pedra <b>C</b>	230	22,23	2	1	P-53067	0088381983570	3,30
	115	22,23	1	1	P-53073	0088381983587	1,40
	115	22,23	1,6	1	P-53089	0088381983594	1,95
Alumínio <b>D</b>	125	22,23	1	1	P-53095	0088381983600	1,45
	115	22,23	1,6	1	P-53126	0088381983631	1,40

**Pacotes de discos de corte fino**

★★

★★★★



Material	Ø ext. (mm)	Ø int. (mm)	Espessura (mm)	Unds.	Código	EAN	P.V.P. (€)
Inox	115	22,23	1	10	D-65953-10	0088381561815	7,40
Inox	125	22,23	1	10	D-65969-10	0088381561822	8,50
Inox	115	22,23	0,8	12	E-10861-12	0088381581424	21,00
Inox	125	22,23	0,8	12	E-10877-12	0088381581455	24,00

**Discos abrasivos de corte extrafinos**



Material	Ø ext. (mm)	Ø int. (mm)	Espessura (mm)	Unds.	Código	EAN	P.V.P. (€)
Metal	115	22,23	1	1	D-75524	0088381595285	1,05
	125	22,23	1	1	D-75530	0088381595292	1,05
	230	22,23	2	1	D-75568	0088381595322	2,10



**XLOCK**

### Discos abrasivos multimaterial

- O disco de corte fino é adequado para uma vasta gama de materiais.
- Adequados para utilização na construção, canalização, etc.



Material	Ø ext. (mm)	Ø int. (mm)	Espessura (mm)	Unds.	Código	EAN	P.V.P. (€)
Multi material	115	22,23	1,2	1	E-10718	0088381580526	1,65
Multi material	125	22,23	1,2	1	E-10724	0088381580533	1,95



### Discos abrasivos para cortadores



Material	Ø ext. (mm)	Ø int. (mm)	Espessura (mm)	Unds.	Código	EAN	P.V.P. (€)
Metal	355	25,4	3	5	B-10665-5	0088381348058	22,00
Alumínio	355	25,4	2,8	5	E-04977-5	-	42,00
Metal	355	25,4	3	5	E-12790-5	0088381589826	68,00



### Pedras de amolar



B-28662

B-28678

B-51976



B-51960

B-51954

B-51910



Grão	Ø ext. (mm)	Ø int. (mm)	Espessura (mm)	Unds.	Código	EAN	P.V.P. (€)
Para GS5000							
24	125	20	20	1	B-28662	0088381414890	61,00
36	125	20	20	1	B-28678	0088381414906	61,00
Para GS6000							
24	150	20	20	1	B-28684	0088381414913	77,00
36	150	20	20	1	B-28690	0088381414920	77,00

Não ferroso  
Inox  
Metal

Grão	Ø ext. (mm)	Ø int. (mm)	Espessura (mm)	Unds.	Código	EAN	P.V.P. (€)
Para GB801							
120	205	15,88	19	1	B-51976	0088381467490	30,00
60	205	15,88	19	1	B-51960	0088381467483	24,00
60	205	15,88	19	1	B-51954	0088381467476	22,00

Não ferroso  
Inox  
Metal

Grão	Ø ext. (mm)	Ø int. (mm)	Espessura (mm)	Unds.	Código	EAN	P.V.P. (€)
Para GB602							
120	150	12,7	16	1	B-51932	0088381467452	16,50
60	150	1,7	16	1	B-51926	0088381467445	14,80
60	150	12,7	16	1	B-51910	0088381467438	13,10



Novas

MAK PAC

SAT

**Discos de lâminas**

- Para rebarbar, desoxidar, limpar ou rebaixar os cordões de soldadura em metais, alumínio e outras ligas.
- Também podem ser utilizados em trabalhos de carpintaria, decapagem de móveis, lixamento de betumes, trabalhos em vigas velhas, etc.
- Corpo em fibra de vidro: o mais comum no mercado. Mais económico que o de nylon, oferece: Leveza e flexibilidade.
- Corpo de nylon: para os trabalhos de lixamento mais exigentes. São indicados para lixamentos que requerem uma grande pressão sobre o material. Melhor desempenho e maior qualidade.
- Forma de disco curvo: permite trabalhar em superfícies moldadas. Ideal para lixar tubos e cordões de soldadura.
- Forma de disco plano: perfeito para trabalhar em superfícies planas, conseguindo assim um acabamento mais uniforme neste tipo de superfícies.

**Tabela de aplicação**



<b>Madeira</b>		★★★★★			
<b>Plástico</b>		★★★★★			
<b>Metais</b>		★★★★★★	★★★★★★	★★★★★★	
<b>Metais não ferrosos</b>		★★★★★	★★★★★★	★★★★★	
<b>Aço inoxidável</b>			★★★★★★	★★★★★★	
<b>Tijolo, pedra, betão</b>					★★★★★★

**Discos de lâminas - Óxido de alumínio**



- Discos com abrasivo de óxido de alumínio, adequados para uma ampla gama de materiais: metais ferrosos e não ferrosos, plásticos e madeira.



**Tipo Curvo**



**Corpo em fibra de vidro**

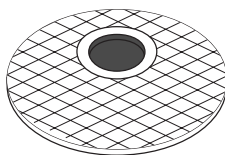

**Materiais**



Metal



Plástico



Madeira



Metais não ferrosos



Ø ext. (mm)	Ø int. (mm)	Grão	R.p.m	Unds.	Código	EAN	P.V.P. (€)
115		40	13.290	1	D-27034	0088381343633	3,40
		60	13.290		D-27040	0088381343640	3,40
		80	13.290		D-27056	0088381343657	3,40
		120	13.290		D-27062	0088381343664	3,40
125	22,23	40	13.290	1	D-27084	0088381343688	3,90
		60	13.290		D-27090	0088381343695	3,90
		80	13.290		D-27109	0088381343701	3,90
		120	13.290		D-27115	0088381343718	3,90
180		40	8.600	1	D-27137	0088381343732	7,70
		60	8.600		D-27143	0088381343749	7,70
		80	8.600		D-27159	0088381343756	7,70
		120	8.600		D-27165	0088381343763	7,70



Discos de lâminas - Carboneto de silício



- Discos com abrasivo de carboneto de silício muito eficazes em materiais como tijolo, pedra e betão.
- Não é necessário trabalhá-lo com água.



**Tipo plano**



**Corpo em fibra de vidro**

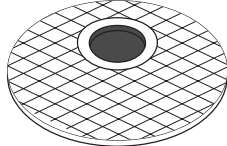

**Materiais**



Tijolo, pedra e betão

Ø ext. (mm)	Ø int. (mm)	Grão	R.p.m	Unds.	Código	EAN	P.V.P. (€)
115		40	13.290	1	D-28036	0088381344630	4,00
		60	13.290		D-28042	0088381344647	4,00
		80	13.290		D-28058	0088381344654	4,00
		120	13.290		D-28064	0088381344661	4,00
125	22,23	40	13.290	1	D-28086	0088381344685	4,50
		60	13.290		D-28092	0088381344692	4,50
		80	13.290		D-28101	0088381344708	4,50
		120	13.290		D-28117	0088381344715	4,50
180		40	8.600	1	D-28139	0088381344739	7,70
		60	8.600		D-28145	0088381344746	7,70
		80	8.600		D-28151	0088381344753	7,70
		120	8.600		D-28167	0088381344760	7,70

- Discos de nylon para os trabalhos mais exigentes. Indicados para lixamentos que requerem uma grande pressão sobre o material, conseguindo assim um poder de lixamento maior. Melhor desempenho e maior qualidade.



**Tipo plano**



**Corpo de nylon**

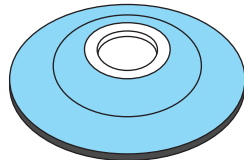

**Materiais**



Tijolo, pedra e betão

Ø ext. (mm)	Ø int. (mm)	Grão	R.p.m	Unds.	Código	EAN	P.V.P. (€)
115		40	13.290	1	D-28173	0088381344777	5,50
		60	13.290		D-28189	0088381344784	5,50
		80	13.290		D-28195	0088381344791	5,50
180	22,23	40	8.600	1	D-28210	0088381344814	11,00
		60	8.600		D-28226	0088381344821	11,00
		80	8.600		D-28232	0088381344838	11,00
		120	8.600		D-28248	0088381344845	11,00



**Discos de lâminas - Zircónio**



- Discos com abrasivo de Zircónio perfeitos para trabalhos em metal e aço inoxidável.
- “O disco mais popular do mercado”.



**Tipo curvo**



**Corpo em fibra de vidro**

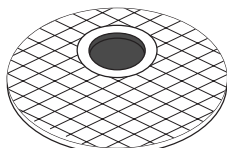

**Materiais**

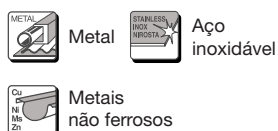

Ø ext. (mm)	Ø int. (mm)	Grão	R.p.m	Unds.	Código	EAN	P.V.P. (€)
115		40	13.290	1	D-63747	0088381525350	2,00
		60	13.290		D-63753	0088381525367	2,00
		80	13.290		D-63769	0088381525374	2,00
		120	13.290		D-63775	0088381525381	2,00
125	22,23	40	13.290	1	D-63781	0088381525398	2,30
		60	13.290		D-63797	0088381525404	2,30
		80	13.290		D-63806	0088381525411	2,25
		120	13.290		D-63812	0088381525428	2,25
180		40	8.600	1	D-63828	0088381525435	4,50
		60	8.600		D-63834	0088381525442	4,50
		80	8.600		D-63840	0088381525459	4,50
		120	8.600		D-63856	0088381525466	4,50



**NOVIDADE**

115		40	13.290	1	D-74186	0088381587228	1,85
		60	13.290		D-74192	0088381587235	1,85
		80	13.290		D-74201	0088381587242	1,85
		120	13.290		D-74217	0088381587259	1,85
125	22,23	40	13.290	1	D-74223	0088381587266	2,15
		60	13.290		D-74239	0088381587273	2,15
		80	13.290		D-74245	0088381587280	2,15
		120	13.290		D-74251	0088381587297	2,15
180		40	8.600	1	D-74267	0088381587303	4,50
		60	8.600		D-74273	0088381587310	4,50
		80	8.600		D-74289	0088381587327	4,50
		120	8.600		D-74295	0088381587334	4,50

- Os discos de nylon são ideais para os trabalhos de lixamento mais exigentes. São indicados para lixamentos que requerem uma grande pressão sobre o material, conseguindo assim um poder de lixamento maior do que com qualquer outro disco.
- Oferecem maior desempenho e maior qualidade. Mantêm as lâminas até ao fim do abrasivo.



### Discos abrasivos - Scotch

- Discos abrasivos de Scotch para a limpeza de superfícies metálicas, de aço inoxidável ou de metais não ferrosos. Também podem ser utilizados em superfícies polidas de pedra.
- O acabamento obtido com estes discos é melhor do que o obtido com discos de lâminas e discos de retificação.
- Com este tipo de discos não é necessário aplicar demasiada pressão, conseguimos um bom lixamento com pouca força, por isso obtemos um acabamento muito bom e uma maior vida útil do disco.
- São ideais para superfícies irregulares, como chapa palito, graças à ligeira flexibilidade dos discos.



Ø ext. (mm)	Ø int. (mm)	Unds.	Código	EAN	P.V.P. (€)
115	22,23	1	B-28977	0088381415200	10,20
125	22,23	1	B-28983	0088381415217	11,30

### Discos de lâminas - Velo

- Indicado para o polimento de metais. Perfeito para aços fortes e ligas resistentes à corrosão.
- Contém pouco Fe, S e Cl, portanto, é resistente à ferrugem.
- Dependendo da espessura da fibra, podemos remover rebarbas ou polir.
- Revestido com uma resina de alumina que permite uma operação mais rápida e menos potente.
- As fibras de velo impedem a abrasão do material.



As fibras de velo finas e flexíveis proporcionam um bom acabamento superficial. Até o dobro da duração dos outros discos de velo. Ideal para usar depois de um disco abrasivo.



Ø ext. (mm)	Ø int. (mm)	Grão	Unds.	Código	EAN	P.V.P. (€)
115	22,23	Grosso	1	B-40917	0088381439237	10,20
125		Grosso		B-40951	0088381439275	11,80
115		Médio		B-40923	0088381439244	10,20
125		Médio		B-40967	0088381439282	11,80
115		Fino		B-40939	0088381439251	10,20
125		Fino		B-40973	0088381439299	11,80
115		Super fino		B-40945	0088381439268	10,20
125		Super fino		B-40989	0088381439305	11,80



Grosso

Médio

Fino

Super fino

#### Aplicação

#### Polimento



Limpeza em cordões de soldadura



Polimento em óxido



Disco de lâminas

Disco de velo

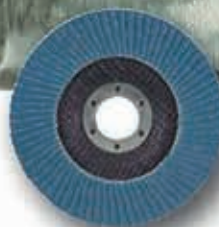

**Brocas tungsténio TCT**



Descrição			Ø (mm)	Comp. total	Comp. útil	Inserção	Tipo de Grão	Tipo de corte	Aplicação	Código	EAN	P.V.P (€)
Brocas tungsténio TCT			10	45	20	6	SC	Diamante	Metal e Aço inoxidável	B-52750	0088381470131	17,00
							SF			B-52788	0088381470193	17,00
							SL			B-52819	0088381470254	17,00
							SM			B-52847	0088381470315	17,00

**Mós abrasivas**

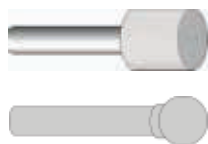

Modelo	Tipo de abrasivo	Inserção	Ø da mó (mm)	Unds.	Código	EAN	P.V.P. (€)
GD0600 GD0601 GD0602 GD0603	A para aço médio	3	5	1	794050-2	0088381110211	8,00
GD0800C GD0801C GD0810C GD0811C		3	10	1	794053-6	0088381110242	1,40
		3	10	1	794059-4	0088381110303	4,00



**Punhos**

Modelo	Descrição	Unds.		Código	EAN	P.V.P. (€)
Para rebarbadoras de: 115 mm 125 mm 150 mm	Rígido	1		153489-2	0088381193054	1,20
	Antivibração	1		162258-0	0088381343381	13,70
Para rebarbadoras de: 9015B 9016B Lixadora 9218SB	Rígido	1		152492-0	0088381131599	3,05
Para rebarbadoras de: 180 mm 230 mm	Antivibração	1		162264-5	0088381345828	16,10
	De corte	1		194684-5	0088381349895	14,80



**Coletores de pó**

O pó pode causar doenças respiratórias graves. Para tentar evitá-lo, a Makita recomenda o uso de um coletor de pó com uma taxa de aspiração de até 90% das partículas. Caixa de alumínio para maior vida útil. Possibilidade de bloquear o disco na profundidade desejada. Visor com protetor transparente.

**Coletor de pó rebarbadoras 230 mm**



Ø (mm)	Descrição	Unds.	Código	EAN	P.V.P. (€)
230	Alumínio. Possibilidade de bloquear o disco. Visor transparente.	1	198440-5	0088381487368	146,00

**Coletor de pó rebarbadoras 125 mm**



Ø (mm)	Descrição	Unds.	Código	EAN	P.V.P. (€)
125	Alumínio. Possibilidade de bloquear o disco. Visor transparente.	1	196845-3	0088381442527	81,00
125	Com engate rápido sem ferramentas*.	1	191G06-2	0088381566001	87,00

\* Para rebarbadoras com engate rápido do disco.

Coletores de pó adequados para rebarbadoras de 115 mm, 125 mm e 180 mm. Especialmente concebido para usos em lixamentos com discos de diamante em betão. Modelos de rebarbadoras compatíveis: 1100 W de potência ou superior. Alta capacidade de aspiração. Adequado para esquinas graças ao seu sistema de duas peças.

Modelos	Diâmetro (mm)	Descrição	Unds.	Código	EAN	P.V.P. (€)
Rebarbadoras 115 / 125 mm X-LOCK	115 / 125	Especial para uso em lixamentos com discos.	1	191F81-2	0088381565479	52,00
Rebarbadoras 115 mm / 125 mm	115 / 125		1	195239-9	0088381361804	52,00
Rebarbadoras 180 mm	180		1	195385-8	0088381369381	71,00



Protetores de disco

Tipo padrão



Parafuso



Rápido

Modelos	Ø (mm)	Fecho	Unds.	Código	EAN	P.V.P. (€)
9557NBR	115	Parafuso	1	123098-1	0088381451383	7,70
9557NBRK1			1	123098-1	0088381451383	7,70
9557NBRX2			1	123098-1	0088381451383	7,70
DGA452	125	Parafuso	1	123098-1	0088381451383	7,70
9558NBR			1	123099-9	0088381451390	8,30
9558NBRK1			1	123099-9	0088381451390	8,30
9558PBY	125	Rápido	1	123099-9	0088381451390	8,30
9565CR			1	123145-8	0088381420181	9,70
9565CVR			1	123145-8	0088381420181	9,70
9565PCV	150	Rápido	1	123145-8	0088381420181	9,70
9566PCV01			1	123146-6	0088381420198	12,10
GA4530R			1	123098-1	0088381451383	7,70
GA4534	115	Parafuso	1	123098-1	0088381451383	7,70
GA4540C			1	123144-0	0088381420167	10,40
DGA454			1	123144-0	0088381420167	10,40
DGA458	115	Rápido	1	123144-0	0088381420167	10,40
DGA461			1	123144-0	0088381420167	10,40
DGA463			1	123144-0	0088381420167	10,40
DGA467	115	Rápido	1	123144-0	0088381420167	10,40
GA4540RZ			1	123098-1	0088381451383	7,70
GA022			1	347479-7	-	5,25
GA028	115	Rápido	1	347479-7	-	5,25
GA5021C			1	123145-8	0088381420181	9,70
DGA504			1	123145-8	0088381420181	9,70
DGA508	125	Rápido	1	123145-8	0088381420181	9,70
DGA511			1	123145-8	0088381420181	9,70
DGA513			1	123145-8	0088381420181	9,70
DGA516	125	Rápido	1	123145-8	0088381420181	9,70
DGA517			1	123145-8	0088381420181	9,70
DGA518			1	123145-8	0088381420181	9,70
GA5030R	125	Parafuso	1	123099-9	0088381451390	8,30
GA5034			1	123099-9	0088381451390	8,30
GA5040C			1	123145-8	0088381420181	9,70
GA5040C01	125	Rápido	1	123145-8	0088381420181	9,70
GA5040RZ			1	123099-9	0088381451390	8,30
DGA519			1	347618-9	-	8,40
GA041	115	Rápido	1	347618-9	-	8,40
GA044			1	347618-9	-	8,40
GA013			1	347480-2	-	6,10
GA023	115	Rápido	1	347480-2	-	6,10
GA029			1	347480-2	-	6,10

Modelos	Ø (mm)	Fecho	Unds.	Código	EAN	P.V.P. (€)
GA6021C	150	Rápido	1	123146-6	0088381420198	12,10
GA6040C			1	123146-6	0088381420198	12,10
GA7012C	180	Parafuso	1	122846-5	3240890337726	14,00
GA7020R			1	122889-7	0088381364447	9,60
GA7030R			1	122889-7	0088381364447	9,60
GA7040R			1	122889-7	0088381364447	9,60
GA7050			1	122889-7	0088381364447	9,60
GA7050R			1	122889-7	0088381364447	9,60
GA7060R			1	122889-7	0088381364447	9,60
GA7061R	180	Rápido	1	122889-7	0088381364447	9,60
GA9012C			1	163411-1	0088381201155	32,00
GA9020R			1	122891-0	3240890337696	11,00
GA9020RKD			1	122891-0	3240890337696	11,00
GA9020SFYK			1	122891-0	3240890337696	11,00
GA9030R			1	122891-0	3240890337696	11,00
GA9040R			1	122891-0	3240890337696	11,00
GA9050	230	Parafuso	1	122891-0	3240890337696	11,00
GA9050R			1	122891-0	3240890337696	11,00
GA9060R			1	122891-0	3240890337696	11,00
GA9061R	230	Rápido	1	122891-0	3240890337696	11,00
DGA900			1	122847-3	-	16,50
DGA901			1	122847-3	-	16,50
GA038G	230	Rápido	1	122847-3	-	16,50
DGA900			1	127714-7	-	12,30
DGA901			1	127714-7	-	12,30
GA038G	230	Rápido	1	127714-7	-	12,30
GA038G			1	127714-7	-	12,30

Tipo especial para corte com disco abrasivo



122913-6



199709-0

Ø (mm)	Fecho	Unds.	Código	EAN	P.V.P. (€)
125 mm	Parafuso	1	122911-0	0088381367134	8,90
230 mm		1	122913-6	0088381367141	17,40
115 mm	Para colocar sobre o protetor	1	199709-0	0088381544665	10,10
125 mm		1	199710-5	0088381544672	10,60

Anilha centradora e porca



224415-9



224543-0

Descrição	Tipo	Modelos	Unds.	Código	EAN	P.V.P. (€)
Anilha	M14	"Ø 115, Ø 125, Ø 150, Ø 180, Ø 230 mm."	1	224415-9	0088381348256	1,70
Porca	M14		1	224543-0	0088381116176	2,10

**Tipo especial para limpeza com catrabuchas**



Ø (mm)	Fecho	Unds.	Código	EAN	P.V.P. (€)
60 - 75 mm	Parafuso	1	192454-6	0088381200912	42,00

**Protetor para rebarbadoras retas**



Modelos	Ø (mm)	Fecho	Unds.	Código	EAN	P.V.P. (€)
GS5000	125	Parafuso	1	123199-5	3240890390677	24,00
GS6000	150			123200-6		25,00

**Porca de fecho rápido Ezy nut**



Descrição	Tipo	Modelos	Unds.	Código	EAN	P.V.P. (€)
Porca rápida	M14	Rebarbadoras 180mm e 230mm	1	195354-9	0088381367189	55,00

**Super - Flange (aperto automático)**



Descrição	Tipo	Modelos	Unds.	Código	EAN	P.V.P. (€)
Anilha	M14	Todos os modelos	1	192227-7	0088381117371	15,40
Porca	M14		1	125052-1	0088381155960	12,10

**Conjunto de filtros**



Modelos	Unds.	Código	EAN	P.V.P. (€)
GA4550R GA5050R	1	199514-5	0088381586559	28,00
GA4540R GA4540C GA5040R GA5040C GA6040C SA5040C	1	198719-4	0088381534857	17,20
9565CR 9565CVR	1	193903-6	0088381187619	16,00
9565PCV	1	195446-4	0088381486057	12,10
GA7012C GA9012C GA5021C GA6021C	1	193956-5	0088381191982	9,10
GA7020R GA7030R GA7040R GA9020R GA9030R GA9040R	1	194289-1	0088381341950	2,20



**Rebarbadoras angulares**



**Rebarbadoras retas**



**Rebarbadoras retas com discos**





**Casquilhos cónicos para rebarbadoras retas**



Porca



Casquilho



Modelo	Ø (mm)	Descrição	Unds.	Código	EAN	P.V.P. (€)
GD0600 GD0601	3	Casquilho	1	763627-4	0088381114769	13,20
	6		1	763620-8	0088381114776	10,80
	6,35 (1/4")		1	763625-8	0088381102339	12,70
	-	Porca	1	763664-8	3240890340672	1,40
GD0602 DGD800	3	Casquilho	1	763669-8	0088381435925	18,20
	6		1	763670-3	0088381435932	9,10
	8		1	763671-1	0088381435949	18,20
	-	Porca	1	763668-0	0088381495714	1,65
GD0603	6	Casquilho	1	763620-8	0088381114776	10,80
	-	Porca	1	763236-9	0088381495684	3,15
GD0800C GD0801C GD0810C GD0811C	3	Casquilho + Porca	1	193011-3	0088381156394	25,00
	6		1	193012-1	0088381156400	20,00
	6,35 (1/4")		1	193143-6	0088381156363	25,00
			1	192988-9	0088381156387	26,00
	6	Casquilho	1	763646-0	0088381170345	15,40
	-	Porca	1	763645-2	0088381170338	2,60



**Suporte**



Modelos	Unds.	Código	EAN	P.V.P. (€)
GD0800C GD0810C	1	193141-0	0088381156745	68,00

**Punho lateral**



Modelos	Unds.	Código	EAN	P.V.P. (€)
GD0600C GD0601C GD0800C GD0810C	1	192985-5	0088381156417	15,00

**Chaves para rebarbadoras retas**



Modelo	Medida (mm)	Unds.	Código	EAN	P.V.P. (€)
GD0602 GD0601 GD0600	13	1	781039-9	0088381290630	1,25
GD0800C GD0810C	19	1	781206-6	0088381124072	4,10
GD0800C GD0810C	13	1	781203-2	0088381102476	2,80

**Chaves de pivôs**



Modelos	Unds.	Código	EAN	P.V.P. (€)
115, 125 e 150mm	1	782423-1	0088381572323	1,70
180 - 230 mm	1	197610-3	0088381519007	2,30



**Acessórios para cortadores**

**Válvula completa**



Modelos	Unds.	Código	EAN	P.V.P. (€)
4101RH	1	153409-6	0088381201148	18,90

**Tubo de vinil**



Modelos	Unds.	Código	EAN	P.V.P. (€)
4100NB 4101RH	1	412088-2	0088381538459	3,50

**Guia lateral**



Modelos	Unds.	Código	EAN	P.V.P. (€)
5604R 5704R 4100KB 4101RH N4105KB 4131	1	164095-8	0088381101080	1,95

**Adaptador de guia de carril 4100KB**



**Interruptor de segurança**



Modelos	Unds.	Código	EAN	P.V.P. (€)
4101RH	1	652739-7	-	105,00



Modelos	Unds.	Código	EAN	P.V.P. (€)
4100KB	1	198673-2	0088381497374	27,00

**Acessórios para PW5000CH**

**Protetor de cabeça**



Unds.	Código	EAN	P.V.P. (€)
1	417322-5	0088381156981	8,10

**Punho**



Unds.	Código	EAN	P.V.P. (€)
1	153489-2	0088381193054	1,20



**Acessórios para PC5001C**

**Saco de pó**



Unds.	Código	EAN	P.V.P. (€)
1	122853-8	0088381358637	5,20

**Conjunto de escovas**



Unds.	Código	EAN	P.V.P. (€)
1	194921-7	0088381358675	8,20

**Chave 5,6**



Unds.	Código	EAN	P.V.P. (€)
1	410047-0	0088381123686	0,80



**Casquilho redutor**



Ø exterior (mm)	Ø interior (mm)	Unds.	Código	EAN	P.V.P. (€)
22,23	20	10	A-85248	0088381538596	9,40
25,4	20	1	197318-9	0088381234733	11,70



**Conjunto de filtros de aire**

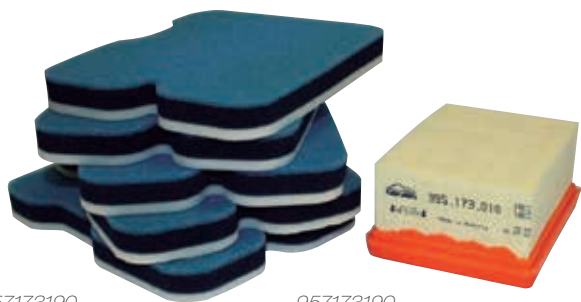

957173190

957173190

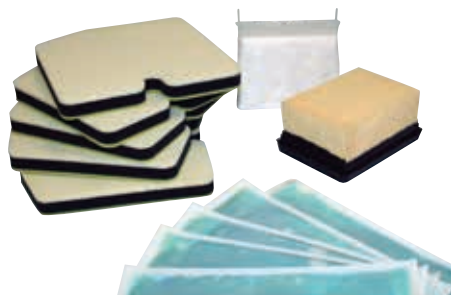

195599-9

Descrição	Modelo	Unds.	Código	EAN	P.V.P. (€)
5 Pré-filtros + filtro	EK7301WS EK8100WS DPC7331 DPC8132	1	957173190	-	21,15
5 Pré-filtros, filtro e caixa de pó	EK7651H	1	195599-9	0088381376884	70,00



**Óleos**



Descrição	Unds.	Código	EAN	P.V.P. (€)
Óleo de motor 4T (220ml) EK7651H	1	195532-1	0088381401937	8,00

**Bomba de pressão**



Modelos	Unds.	Código	EAN	P.V.P. (€)
DPC7331 DPC8132 EK6100 EK7651H 4101RH	1	957802600	4002829128633	434,00

**Kit de água para EK7651**

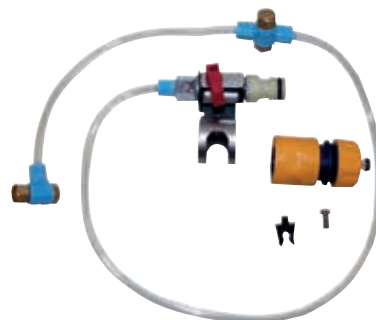

Modelo	Unds.	Código	EAN	P.V.P. (€)
EK7651	1	195534-7	3240890392091	28,00



**Pé com rodas**



Modelos	Unds.	Código	EAN	P.V.P. (€)
EK8100WS EK7301WS	1	394114272	-	64,00

**Carros de transporte**



Tipo	Modelo	Unds.	Código	EAN	P.V.P. (€)
DT4000	EK7651H	1	196354-2	0088381430517	987,00



**Acessórios para DCC501**



Capaz de cortar a seco como molhado, trocando o protetor. Cortes em pedra, alvenaria, ladrilhos, betão e muito mais.



Descrição	Unds	Código	EAN	P.V.P. (€)
Tubo de água completo	1	140Y23-7	-	7,40
Adaptador de depósito de água	1	140Y22-9	-	8,50
Depósito de água	1	140Y25-3	-	3,90
Caixa de pó	1	127750-3	-	14,10
Saco de pó	1	126738-0	0088381589802	6,40



# Cortador

**CE001G XGT**

**XGT X2**  
80V max

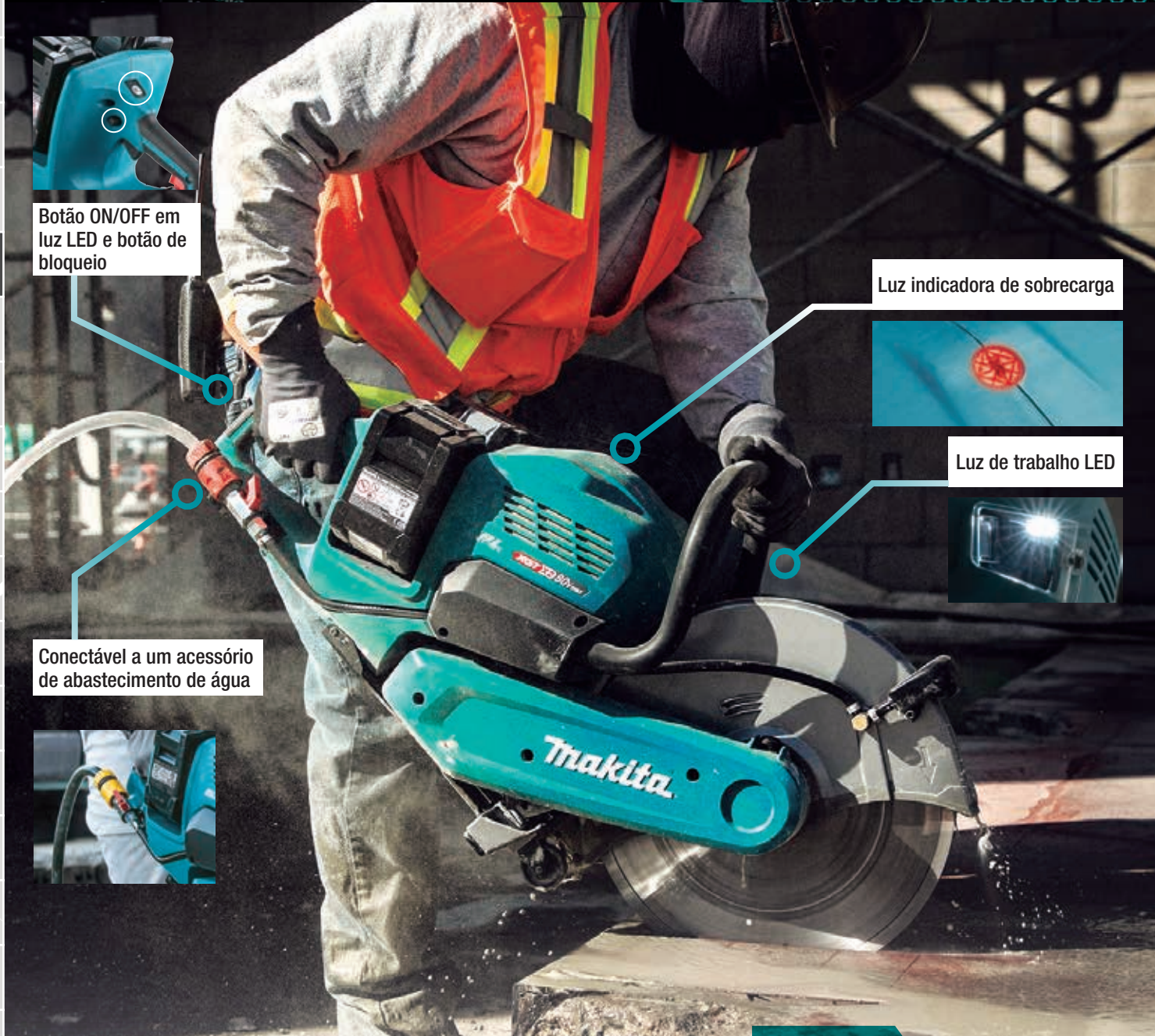

Botão ON/OFF em luz LED e botão de bloqueio

Luz indicadora de sobrecarga



Luz de trabalho LED



Conectável a um acessório de abastecimento de água



Capacidade máx. de corte  
**127mm**

Equipado com:  
**BL MOTOR AFT WG XPT**  
WET GUARD EXTREME PROTECTION TECHNOLOGY

**Velocidade de corte do betão**

**CE001G**  
Modelo anterior de gasolina

Bateria: BL4050F x 2 (uma só carga)

**Equipado com caixa anti-vibração**

Com mola incorporada para absorver as vibrações de corte nas pegas dianteira e traseira.

Pega frontal / Pega traseira  
**2,0/1,2 m/s**



Caixa anti-vibração

Área de movimento

Corte contínuo de betão: 50 x 300mm  
Disco de diamante: 355mm

# *Abrasivo - Lixas*



**Lixadoras orbitais**

**Lixas para BO4556**



- Excelente desempenho de lixamento em aplicações profissionais.
- Aplicações: lixamento de madeira, ferro e madeira pintada. Óxido de alumínio.
- Com grão semiaberto e revestimento de resina sobre cola.

Medida (mm)	Grão	Unds.	Código	EAN	P.V.P. (€)
114 x 140	40	10	P-36398	0088381972109	4,10
	60		P-32904	0088381961066	3,60
	80		P-36407	0088381972116	3,60
	100		P-32910	0088381961073	3,30
	120		P-32926	0088381961080	3,30
	150		P-32932	0088381961097	3,05
	180		P-36413	0088381972123	3,30
	240		P-36429	0088381972130	3,30

**Lixas para BO4566**

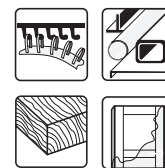
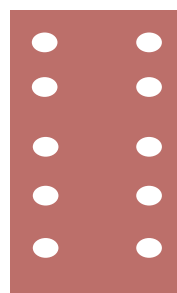

- Lixa de grão aberto de corindo com revestimento duplo de resina.
- Aplicações: lixamento de madeira seca, pintada ou envernizada.
- Também para metal. Perfeito para trabalhos de marcenaria e carroçaria. Orifícios de aspiração 5 + 5.

Medida (mm)	Grão	Unds.	Código	EAN	P.V.P. (€)
100 x 240	40	10	P-42868	0088381970730	6,60
	60		P-42874	0088381970747	6,60
	80		P-42880	0088381970754	6,30
	100		P-42896	0088381970761	6,30
	120		P-42905	0088381970778	6,30
	150		P-42911	0088381970785	6,00
	180		P-42927	0088381970792	6,00
	240		P-42933	0088381970808	6,00

- Especialmente concebidas para pintura.
- Excelente desempenho em aplicações profissionais.
- Aplicações: lixamento de tinta, verniz, madeira pintada...



Medida (mm)	Grão	Unds.	Código	EAN	P.V.P. (€)
114 x 140	40	10	P-36516	0088381972222	5,00
	60		P-36522	0088381972239	4,40
	80		P-36538	0088381972246	4,40
	100		P-36544	0088381972253	4,40
	120		P-36550	0088381972260	4,40
	150		P-36566	0088381972277	4,40
	180		P-36572	0088381972284	4,40
	240		P-36588	0088381972291	4,40



**Makita**



**Lixadoras orbitais**

**Lixas para BO4565**

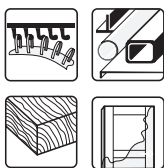

- Excelente desempenho de lixamento em aplicações profissionais.
- Aplicações: lixamento de madeira, ferro e madeira pintada.
- Óxido de alumínio extrarresistente e aderência por velcro. Orifícios de aspiração 3+3.

Medida (mm)	Grão	Unds.	Código	EAN	P.V.P. (€)
114 x 102	40	10	P-33087	0088381961240	5,00
	60		P-33093	0088381961257	5,00
	80		P-33102	0088381961264	5,00
	100		P-33118	0088381961271	5,00
	120		P-33124	0088381961288	4,40
	150		P-33130	0088381961295	4,40
	180		P-33146	0088381961301	4,40
	240		P-33152	0088381961318	4,40
	320		P-33168	0088381961325	4,40

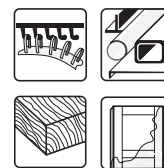

- Para uso com a maioria das lixadoras tipo delta com base triangular.
- Aplicações: lixamento de madeira, metal. Ideal para esquinas e lixamento de acabamento.
- Lixa triangular com aderência por velcro e 6 orifícios de aspiração.

Medida (mm)	Grão	Unds.	Código	EAN	P.V.P. (€)
93 x 93 x 93	40	10	P-33255	0088381961417	4,10
	60		P-33261	0088381961424	4,10
	80		P-33277	0088381961431	4,10
	100		P-33283	0088381961448	3,90
	120		P-33299	0088381961455	3,90
	150		P-33308	0088381961462	3,90
	180		P-33314	0088381961479	3,90
	240		P-33320	0088381961486	3,90
	320		P-33336	0088381961493	3,90



- Especialmente concebidas para pintura. Excelente desempenho em aplicações profissionais. 6 orifícios de aspiração.
- Aplicações: lixamento de tinta, verniz, madeira pintada.

Medida (mm)	Grão	Unds.	Código	EAN	P.V.P. (€)
114 x 102	40	10	P-35807	0088381964968	5,80
	60		P-35813	0088381964975	5,50
	80		P-35829	0088381964982	5,20
	100		P-35835	0088381964999	5,20
	120		P-35841	0088381965002	5,20
	150		P-35857	0088381966016	5,20
	180		P-35863	0088381966023	5,20
	240		P-35879	0088381966030	5,20
	320		P-35885	0088381966047	5,20



- Especialmente concebidas para pintura. Para uso com a maioria das lixadoras tipo delta com base triangular. 6 orifícios de aspiração.
- Excelente desempenho em aplicações profissionais.
- Aplicações: lixamento de tinta, verniz, madeira pintada.

Medida (mm)	Grão	Unds.	Código	EAN	P.V.P. (€)
93 x 93 x 93	40	10	P-42684	0088381970556	4,40
	60		P-42690	0088381970563	4,10
	80		P-42709	0088381970570	4,10
	100		P-42715	0088381970587	4,10
	120		P-42721	0088381970594	4,10
	150		P-42737	0088381970600	4,10
	180		P-42743	0088381970617	4,10
	240		P-42759	0088381970624	4,10
	320		P-42765	0088381970631	4,10

**Lixadoras orbitais**

**Lixas para BO3700 / 9036 / BO3711 / DBO380 / DBO381**

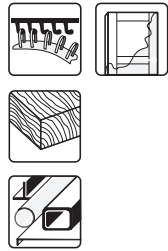

- Excelente desempenho de lixamento em aplicações profissionais.
- Aplicações: Lixamento de madeira, ferro e madeira pintada.
- Perfurações 4 + 4.

Medida (mm)	Grão	Unds.	Código	EAN	P.V.P. (€)
93 x 185	40	10	P-31871	0088381960038	5,50
	60		P-31887	0088381960045	5,00
	80		P-31893	0088381960052	5,00
	100		P-31902	0088381960069	5,00
	120		P-35891	0088381966054	5,00
	150		P-35900	0088381966061	5,00
	180		P-35916	0088381966078	5,00
	240		P-35922	0088381966085	5,00



- Excelente desempenho de lixamento em aplicações profissionais.
- Lixa de grão aberto de corindo com revestimento duplo de resina.
- Ideal para lixar madeira seca, pintada ou envernizada.
- Também adequada para metal. Perfeita para trabalhos de marcenaria e carroçaria.

Medida (mm)	Grão	Unds.	Código	EAN	P.V.P. (€)
93 x 228	40	10	P-36136	0088381966290	3,30
	60		P-32948	0088381961103	3,05
	80		P-36142	0088381966306	3,05
	100		P-32954	0088381961110	3,05
	120		P-36158	0088381966313	3,05
	150		P-32960	0088381961127	2,45



- Excelente desempenho de lixamento em aplicações profissionais.
- Lixa de grão aberto de corindo com revestimento duplo de resina.
- Ideal para lixar madeira seca, pintada ou envernizada. Também adequada para metal.
- Perfeita para trabalhos de marcenaria e carroçaria.
- Perfurações 4 + 4.

Medida (mm)	Grão	Unds.	Código	EAN	P.V.P. (€)
93 x 228	40	10	P-31837	0088381959995	3,90
	60		P-31843	0088381960007	3,60
	80		P-31859	0088381960014	3,60
	100		P-31865	0088381960021	3,60
	120		P-36011	0088381966177	3,60
	150		P-36027	0088381966184	3,60
	180		P-36033	0088381966191	3,60
	240		P-36049	0088381966207	3,60



**Makita**

**Lixadoras orbitais**

**Lixas para BO4900V / 9046 / BO4901**

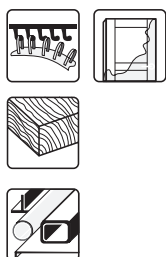

- Excelente desempenho de lixamento em aplicações profissionais.
- Lixa de grão aberto de corindo com revestimento duplo de resina.
- Ideal para lixar madeira seca, pintada ou envernizada.
- Também adequada para metal.
- Perfeita para trabalhos de marcenaria e carroçaria.
- Perfurações 5 + 5.

Medida (mm)	Grão	Unds.	Código	EAN	P.V.P. (€)
115 x 229	40	10	P-33174	0088381961332	6,90
	60		P-33180	0088381961349	6,60
	80		P-33196	0088381961356	6,60
	100		P-33205	0088381961363	6,60
	120		P-33211	0088381961370	6,60
	180		P-33233	0088381961394	6,30
	240		P-33249	0088381961400	6,30

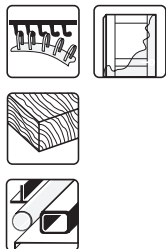

- Lixa de alta resistência. Excelente desempenho de lixamento em aplicações profissionais.
- Lixa de grão aberto de corindo com revestimento duplo de resina.
- Ideal para lixar madeira seca, pintada ou envernizada. Também adequada para metal.
- Perfeita para trabalhos de marcenaria e carroçaria.
- Perfurações 5 + 5 + 2 + 2.

Medida (mm)	Grão	Unds.	Código	EAN	P.V.P. (€)
115 x 229	40	10	P-43022	0088381970891	7,70
	60		P-43038	0088381970907	7,20
	80		P-43044	0088381970914	6,90
	100		P-43050	0088381970921	6,60
	120		P-43066	0088381970938	6,60
	150		P-43072	0088381970945	6,00
	180		P-43088	0088381970952	6,60
240	P-43094	0088381970969	6,60		

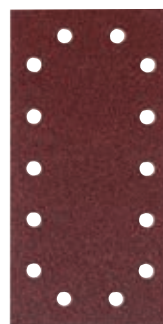

- Excelente desempenho de lixamento em aplicações profissionais.
- Lixa de grão aberto de corindo com revestimento duplo de resina.
- Ideal para lixar madeira seca, pintada ou envernizada.
- Também adequada para metal.
- Perfeita para trabalhos de marcenaria e carroçaria.
- Perfurações 5 + 5 + 2 + 2.

Medida (mm)	Grão	Unds.	Código	EAN	P.V.P. (€)
115 x 280	40	10	P-33009	0088381961165	4,70
	60		P-33015	0088381961172	4,40
	80		P-33021	0088381961189	4,40
	100		P-33037	0088381961196	4,40
	120		P-33043	0088381961202	4,40
	150		P-33059	0088381961219	4,40
	180		P-33065	0088381961226	4,40
	240		P-33071	0088381961233	4,10



- Excelente desempenho de lixamento em aplicações profissionais.
- Lixa de grão aberto de corindo com revestimento duplo de resina.
- Ideal para lixar madeira seca, pintada ou envernizada.
- Também adequada para metal.
- Perfeita para trabalhos de marcenaria e carroçaria.

Medida (mm)	Grão	Unds.	Código	EAN	P.V.P. (€)
115 x 280	40	10	P-36267	0088381966429	4,40
	60		P-32976	0088381961134	4,10
	80		P-36273	0088381966436	4,10
	100		P-32982	0088381961141	4,10
	120		P-36289	0088381966443	4,10
	150		P-32998	0088381961158	3,30



**Lixadoras orbitais**

**Rolos de lixa**



- Para uso geral. Adequada para madeira, metal, tinta e verniz.
- Rolo de 5 m.
- Ideal para lixadoras orbitais.
- Adequado como lixa manual.

Largura (mm)	Grão	Comp. (m)	Unds.	Código	EAN	P.V.P. (€)
120	40	5	1	P-38102	0088381973816	8,60
	60			P-38118	0088381973823	6,60
	80			P-38124	0088381973830	5,80
	100			P-38130	0088381973847	5,50
	120			P-38146	0088381973854	5,50
	180			P-38152	0088381973861	5,50
	240			P-38168	0088381973878	5,50
	320			P-38174	0088381973885	5,50
	400			P-38180	0088381973892	4,40



- Para uso geral. Adequada para madeira, metal, tinta e verniz.
- Rolo de 50 m.
- Ideal para lixadoras orbitais.
- Adequado como lixa manual.

Largura (mm)	Grão	Comp. (m)	Unds.	Código	EAN	P.V.P. (€)
120	40	50	1	P-38196	0088381973908	59,00
	60			P-38205	0088381973915	48,00
	80			P-38211	0088381973922	42,00
	100			P-38227	0088381973939	39,00
	120			P-38233	0088381973946	39,00
	180			P-38249	0088381973953	39,00
	240			P-38255	0088381973960	39,00
	320			P-38261	0088381973977	39,00
	400			P-38277	0088381973984	39,00

**Bases para lixadoras orbitais**



158324-9



158326-5



158325-7



140441-9

Modelo	Tipo	Medida	Unds.	Código	EAN	P.V.P. (€)
BO4556 BO4565 BO4566	Quadrada Borracha *	112 x 102	1	158324-9	0088381413596	3,40
	Triangular Velcro	112 x 190	1	158325-7	3240890999597	8,95
	Rectangular Velcro	100 x 164	1	158326-5	3240890999580	7,80
BO3700 BO3711	Borracha	93 x 185	1	140441-9	-	4,75
	Velcro	93 x 185	1	194930-6	0088381355759	15,40
BO4900V BO4901	Borracha	115 x 229	1	193523-6	0088381164719	16,70
	Velcro	115 x 229	1	193521-0	0088381164702	31,20
9046	Velcro	115 x 229	1	162172-0	3240890063304	40,95

\* Para trocar a base de borracha de BO4556 pela base de velcro triangular ou retangular, é necessário utilizar a base 450068-0. \*\* Esta base é considerada um acessório.



**Lixadoras rotorbitais**

**Lixas para BO5040 / BO5041 / DBO180**

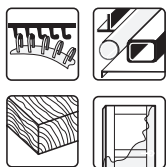

- Lixa de grão semiaberto de óxido de alumínio com revestimento de resina fenólica.
- Ideal para trabalhos em madeira, plástico, chapa metálica, madeira envernizada e metal pintado.
- 8 perfurações.

Ø (mm)	Grão	Unds.	Código	EAN	P.V.P. (€)
125	40	10	P-43533	0088381971409	5,50
	60		P-43549	0088381971416	5,20
	80		P-43555	0088381971423	5,00
	100		P-43561	0088381971430	5,00
	120		P-43577	0088381971447	5,00
	180		P-43583	0088381971454	5,00
	240		P-43599	0088381971461	5,00
	320		P-43608	0088381971478	4,70
	400		P-43614	0088381971485	4,70

**Lixas para BO6030 / BO6050**



- Lixa de grão semiaberto de óxido de alumínio com revestimento de resina fenólica.
- Ideal para trabalhos em madeira, plástico, chapa metálica, madeira envernizada e metal pintado.
- 8 perfurações.

Ø (mm)	Grão	Unds.	Código	EAN	P.V.P. (€)
150	40	10	P-31918	0088381960076	7,70
	60		P-31924	0088381960083	7,40
	80		P-31930	0088381960090	7,20
	100		P-31946	0088381960106	6,90
	120		P-31952	0088381960113	6,90
	150		P-31968	0088381960120	6,90
	180		P-31974	0088381960137	6,90
	220		P-31980	0088381960144	6,90
	240		P-31996	0088381960151	6,90
	320		P-32007	0088381960168	6,90
	400		P-32013	0088381960175	6,90

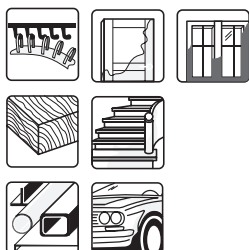

- Especialmente concebidas para pintura.
- Excelente desempenho em trabalhos em automóveis.
- Revestimento antiestático que evita obstruções na lixa para um acabamento mais fino.
- 8 perfurações.

Ø (mm)	Grão	Unds.	Código	EAN	P.V.P. (€)
125	40	10	P-33342	0088381961509	5,00
	60		P-33358	0088381961516	4,70
	80		P-33364	0088381961523	4,40
	100		P-33370	0088381961530	4,40
	120		P-33386	0088381961547	4,40
	180		P-33392	0088381961554	4,40
	240		P-33401	0088381961561	4,40
	320		P-33417	0088381961578	4,40
	400		P-33423	0088381961585	4,40

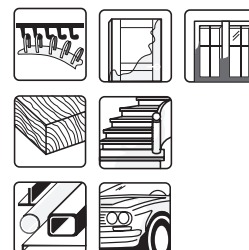
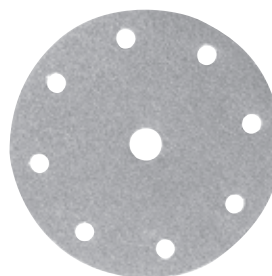

- Especialmente concebidas para pintura.
- Excelente desempenho em trabalhos em automóveis.
- Revestimento antiestático que evita obstruções na lixa para um acabamento mais fino.
- 8 perfurações.

Ø (mm)	Grão	Unds.	Código	EAN	P.V.P. (€)
150	40	10	P-37839	0088381973540	7,40
	60		P-37845	0088381973557	6,90
	80		P-37851	0088381973564	6,60
	100		P-37867	0088381973571	6,30
	120		P-37873	0088381973588	6,30
	150		P-37889	0088381973595	6,30
	180		P-37895	0088381973601	6,30
	220		P-37904	0088381973618	6,30
	240		P-37910	0088381973625	6,30
	320		P-37926	0088381973632	6,30
	400		P-37932	0088381973649	6,30

**Lixadoras rotorbitais e discos de lixa**

**Caixas de discos de velcro perfurados de 150 mm**

- Gama de lixas de óxido de alumínio para lixadoras rotorbitais de 150 mm.
- Embalagens de 50 e 100 unidades.
- Ideais para utilizadores com elevado consumo de lixas.
- Perfeitas para o acabamento em fibra de vidro, madeira, metal e chapa de automóveis.
- Perfurações 8 + 6.

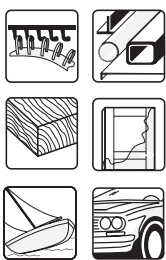

Ø (mm)	Grão	Unds.	Código	EAN	P.V.P. (€)
150	40	50	B-39300	0088381434041	31,00
	60		B-39316	0088381434058	29,00
	80	100	B-39322	0088381434065	51,00
	100		B-39338	0088381434072	48,00
	120		B-39344	0088381434089	46,00
	240		B-39350	0088381434096	45,00
	320		B-39366	0088381434102	45,00
	360		B-39372	0088381434119	45,00
	400		B-39388	0088381434126	45,00
	500		B-39394	0088381434133	45,00
	600	B-39403	0088381434140	45,00	
	800	B-39419	0088381434157	45,00	
	1.000	B-39425	0088381434164	45,00	

**Lixas para lixadoras de disco de 225mm**

- Discos especiais para trabalhos em paredes divisórias secas.
- Grão cerâmico com resina.
- Revestimento especial, evita a obstrução e o desgaste.
- Mais durável que um disco abrasivo.

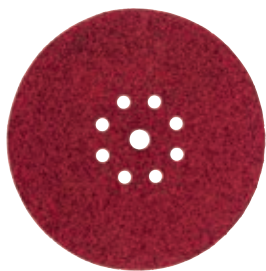

Ø (mm)	Grão	Unds.	Código	EAN	P.V.P. (€)
225	40	25	B-68389	0088381545891	34,00
	80		B-68395	0088381545907	33,00
	120		B-68404	0088381545914	29,00
	180		B-68410	0088381545921	29,00
	320		B-68426	0088381545938	29,00

**Discos de lixa 115mm / 125mm / 180mm**

- Discos de fibra excelentes para remover vernizes e tintas em madeira e metal, bem como correções em soldaduras..



Ø (mm)	Grão	Unds.	Código	EAN	P.V.P. (€)
115	24	5	P-00860	0088381918787	4,50
	40		P-00882	0088381918800	5,90
	60		P-00907	0088381918824	5,90
	80		P-00913	0088381918831	5,90
	120		P-00935	0088381918848	6,20
125	24		P-00957	0088381922203	5,40
	40		P-00979	0088381922227	6,70
	60		P-00985	0088381922234	6,70
	80		P-00991	0088381922241	7,00
	100		P-01002	0088381922258	7,30
180	120		P-01018	0088381922265	7,30
	24		P-01030	0088381918879	8,50
	40		P-01052	0088381918893	8,70
	60		P-01074	0088381918916	8,70
	80		P-01080	0088381918923	8,70
	100	P-01096	0088381918930	8,10	
	120	P-01105	0088381918947	8,10	

**Lixas para lixadoras de disco de 180 mm**

- Lixa de óxido de alumínio de grão aberto com revestimento de resina e cola à base de látex.
- Excelente desempenho em trabalhos em automóveis.
- Perfeita para trabalhos em madeira não tratada, madeira envernizada, carroçaria.
- Especialmente concebida para lixar tinta.



Ø (mm)	Grão	Unds.	Código	EAN	P.V.P. (€)
180	40	10	P-33439	0088381961592	11,00
	60		P-38037	0088381973748	9,10
	80		P-33445	0088381961608	8,60
	100		P-38043	0088381973755	8,20
	120		P-33451	0088381961615	8,20
	240		P-38059	0088381973762	8,20
	320	P-38065	0088381973779	8,20	

**Pratos de velcro para lixadoras / polidoras de disco**



197925-8

**PO6000C**



743060-6

**M14**



199939-3

**DSL801**

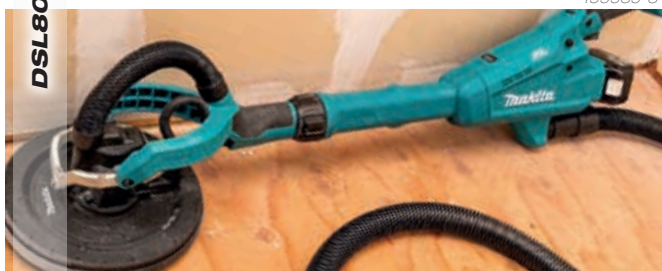

Descrição	Ø (mm)	Unds.	Código	EAN	P.V.P. (€)
PO6000C	100	1	197925-8	00883811468367	62,00
	125		197922-4	00883811468343	61,00
	150		197928-2	00883811468381	61,00
M14	115		743060-6	0088381156967	16,50
	117		P-21777	0088381948876	13,20
	165	743053-3	0088381146104	21,00	
DSL800 DSL801	Suave	210	199939-3	0088381546157	58,00
	Médio		199940-8	0088381546164	65,00
	Duro		199938-5	0088381546140	63,00

**Pratos de borracha para lixadoras / polidoras de disco**



Descrição	Ø (mm)	Unds.	Código	EAN	P.V.P. (€)
Requer porca	115	1	743015-1	0088381102094	9,50
	120		743025-8	0088381101295	5,00
	125		743016-9	0088381109017	10,20
	170		743008-8	0088381109055	25,00
5/8"	170		743012-7	0088381101233	16,50

**Porca para pratos de borracha**



Descrição	Unds.	Código	EAN	P.V.P. (€)
M14	1	224515-5	008838116190	5,50

**Bases para DBO480/81/82**



191Y22-2

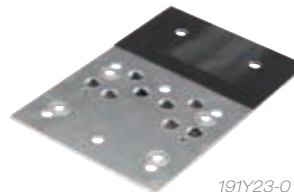

191Y23-0



191Y24-8



191Y25-6



Descrição	Unds.	Código	EAN	P.V.P. (€)
Velcro triangular	1	191Y22-2	0088381590976	10,20
Velcro rectangular	1	191Y23-0	0088381590983	8,00
Velcro quadrado e grampos	1	191Y24-8	0088381590990	6,70
Velcro quadrado	1	191Y25-6	0088381591003	6,00



### Lixas para lixadoras de cinta

- Lixa de óxido de alumínio com grão fechado e revestimento duplo de resina sobre base de tecido.
- Produto de grande resistência concebido especialmente para lixadoras de cinta.
- Adequadas para todos os tipos de madeira e metal.



Modelos	Medida (mm)	Grão	Unds.	Código	EAN	P.V.P. (€)
9910 9911	76 x 457	40	5	P-37091	0088381972802	9,90
		60		P-37100	0088381972819	9,60
		80		P-37116	0088381972826	9,60
		100		P-37122	0088381972833	9,60
		120		P-37138	0088381972840	9,60
		150		P-37144	0088381972857	9,60
		240	P-37150	0088381972864	9,60	



Modelo	Medida (mm)	Grão	Unds.	Código	EAN	P.V.P. (€)
9903	76 x 533	40	5	P-37172	0088381972888	10,50
		60		P-37188	0088381972895	9,90
		80		P-37194	0088381972901	9,40
		100		P-37203	0088381972918	9,10
		120		P-37219	0088381972925	9,10
		150		P-37225	0088381972932	9,10
		240	P-37231	0088381972949	9,10	



Modelos	Medida (mm)	Grão	Unds.	Código	EAN	P.V.P. (€)
9920 9924DB	76 x 610	40	5	P-37312	0088381973021	11,60
		60		P-37328	0088381973038	11,00
		80		P-37334	0088381973045	10,50
		100		P-37340	0088381973052	9,60
		120		P-37356	0088381973069	9,60
		150		P-37362	0088381973076	9,60
		240	P-37378	0088381973083	9,60	



Modelos	Medida (mm)	Grão	Unds.	Código	EAN	P.V.P. (€)
9402 9403 9404	100 x 610	40	5	P-36887	0088381972598	13,80
		60		P-36893	0088381972604	12,70
		80		P-36902	0088381972611	12,70
		100		P-36918	0088381972628	12,70
		120		P-36924	0088381972635	12,70
		150		P-36930	0088381972642	12,70
		240	P-36946	0088381972659	12,70	

### Placas grafitadas



Modelo	Unds.	Código	EAN	P.V.P. (€)
9924DB	1	423036-6	008838116398	2,35
9402		423029-3	008838116367	3,00
9403		421648-9	0088381148191	3,70
9404		193201-8	0088381157056	7,80
9903		423315-2	0088381154291	2,50
9920		423316-0	0088381154307	3,05

### Placas de cortiça



Modelo	Unds.	Código	EAN	P.V.P. (€)
9404	1	193202-6	0088381157063	5,20
9903		423312-8	0088381154321	2,20
9402		421093-8	0088381123839	4,40
9924DB		423035-8	0088381152532	4,10
9403		421646-3	0088381148177	2,80
9901		423149-3	0088381126397	2,80
9920		423313-6	0088381154338	2,80

### Placas de metal



Modelo	Unds.	Código	EAN	P.V.P. (€)
9402	1	342328-3	008838116244	3,05
9924DB		341705-6	008838116268	3,60
9404		151751-9	0088381154284	8,60
9902 9903		151749-6	0088381154246	5,50
9920		151750-1	0088381154277	5,50
9403 (metal + cortiça)		150980-1	0088381148153	5,50
9903		344620-3	0088381148160	2,30
9910 9911		344586-7	0088381146791	2,80





**Cintas de lixa de alta qualidade para 9032**

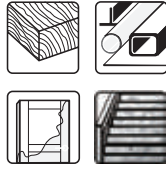
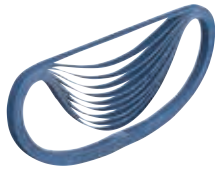

10 und

Modelo	Medida (mm)	Grão	Unds.	Código	EAN	P.V.P. (€)
9032	6x533	80	10	A-34534	0088381164450	22,00
		100		A-34540	0088381164467	20,00
		120		A-34556	0088381164474	19,30
	9x533	40		A-34447	0088381164382	22,00
		60		A-34453	0088381164399	22,00
		80		A-34469	0088381164405	20,00
		100		A-34475	0088381164412	17,70
		120		A-34481	0088381164429	17,70
		13x533		40	A-34562	0088381164481
	60			A-34578	0088381164498	25,00
	80			A-34584	0088381164504	24,00
	100			A-34590	0088381164511	24,00
	120	A-34609	0088381164528	20,00		

25 und

Modelo	Medida (mm)	Grão	Unds.	Código	EAN	P.V.P. (€)
9032	6x533	60	25	P-39394	0088381967266	32,00
	6x533	100		P-39419	0088381967280	32,00
	6x533	120		P-39425	0088381967297	32,00

**Cintas de lixa de alta qualidade para 9031**

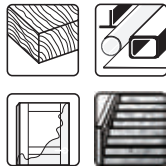

Modelo	Medida (mm)	Grão	Unds.	Código	EAN	P.V.P. (€)
9031	30 x 533	40	5	P-36675	0088381972383	5,20
	30 x 533	60		P-36681	0088381972390	4,70
	30 x 533	80		P-36697	0088381972406	4,70
	30 x 533	100		P-36706	0088381972413	4,70
	30 x 533	120		P-00125	0088381913362	5,15
	30 x 533	150		P-36728	0088381972437	4,70
	30 x 533	240		P-36734	0088381972444	4,70

**Cintas de lixa para LB1200F**



Grão	Medida (mm)	Unds.	Código	EAN	P.V.P. (€)
80	20 x 2240	5	B-42581	0088381440738	14,30
120	20 x 2240		B-42597	0088381440745	14,30

**Cintas de lixa padrão para 9032**

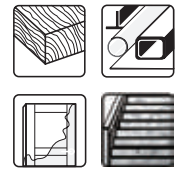
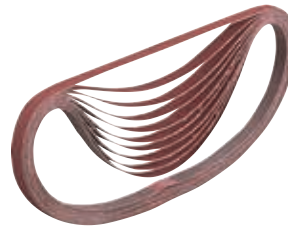

5 und

Modelo	Medida (mm)	Grão	Unds.	Código	EAN	P.V.P. (€)	
9032	6x533	40	5	P-43181	0088381971058	5,80	
		60		P-43197	0088381971065	5,80	
		80		P-43206	0088381971072	5,50	
		100		P-43212	0088381971089	5,50	
		120		P-43228	0088381971096	5,50	
		150		P-43234	0088381971102	5,50	
		240		P-43240	0088381971119	5,50	
		9x533		40	P-43256	0088381971126	6,60
				60	P-43262	0088381971133	6,60
				80	P-43278	0088381971140	6,30
	100		P-43284	0088381971157	6,30		
	120		P-43290	0088381971164	6,30		
	150		P-43309	0088381971171	6,30		
	240		P-43315	0088381971188	6,30		
	13x533		40	P-43321	0088381971195	8,60	
			60	P-43337	0088381971201	8,20	
			80	P-43343	0088381971218	8,00	
		100	P-43359	0088381971225	7,70		
		120	P-43365	0088381971232	7,70		
		150	P-43371	0088381971249	8,00		
		240	P-43387	0088381971256	8,00		

**Cinta de lixa especial vidro para 9031**



Modelo	Medida (mm)	Grão	Unds.	Código	EAN	P.V.P. (€)
9031	30 x 533	40	5	P-01395	0088381922302	12,10
	30 x 533	60		P-01404	0088381922319	12,10
	30 x 533	80		P-01199	0088381913928	11,00
	30 x 533	100		P-01208	0088381913935	11,00
	30 x 533	120		P-01214	0088381913942	11,00
	30 x 533	150		P-01220	0088381913959	11,00
	30 x 533	180		P-01236	0088381913966	11,00



Acessórios de polimento para PV301 e DPV300



743126-2



743124-6



191N90-9



191N91-7



191N92-5



743125-4



Descrição	Grão	Unds.	Código	EAN	P.V.P. (€)
Esponja de velcro (grosseira)	80	1	191N90-9	0088381577045	10,20
Esponja de velcro (média)	80	1	191N91-7	0088381577052	12,70
Boina de lã com velcro	80	1	191N92-5	0088381577069	12,70
Prato de velcro	80	1	743125-4	0088381587860	37,00

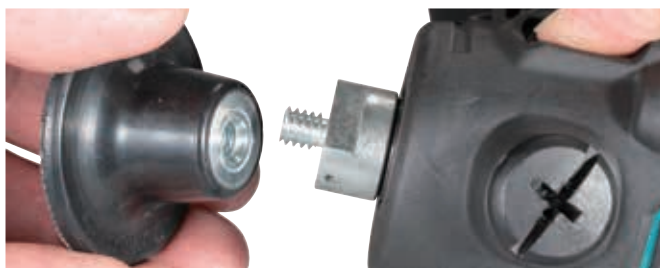

Descrição	Grão	Unds.	Código	EAN	P.V.P. (€)
Discos de lixa	A60	25	E-07412	0088381574044	47,00
	A80		E-07428	0088381574051	47,00
	A120		E-07434	0088381574068	47,00
	Z60		E-07440	0088381574075	47,00
	Z80		E-07456	0088381574082	47,00
Discos abrasivos para superfície	Grosso	25	E-07462	0088381574099	87,00
	Médio		E-07478	0088381574105	87,00
	Fino		E-07484	0088381574112	87,00
	Médio		E-07490	0088381574129	76,00
	Fino		E-07509	0088381574136	76,00
	Muito fino		E-07515	0088381574143	76,00
Adaptador	-	1	743126-2		5,60
Prato	-		743124-6	0088381587853	14,30





PV001GZ



**XGT**  
**40V** Li-ion  
max





**Adaptador de boina duplo**



Descrição	Unds.	Código	EAN	P.V.P. (€)
Adaptador de boina duplo	1	D-56960	0088381457620	2,30

**Prato de velcro**



Modelo	Descrição	Ø (mm)	Unds.	Código	EAN	P.V.P. (€)
BO5030 BO5031 BO5040 BO5041	Macio (lixamento geral)	123	1	743081-8	0088381350044	32,00
	Duro (lixamento grosseiro)	150		196685-9	0088381438957	26,00
	Macio (lixamento geral)	150		196684-1	0088381438940	30,00
BO6040 BO6030	Super macio (lixamento fino)	150	1	196686-7	0088381438964	29,00
	Duro (lixamento grosseiro)	150		197315-5	0088381461955	52,00
BO6050J	Macio (lixamento geral)	150	1	197314-7	0088381461948	48,00
	Super macio (lixamento fino)	150		197316-3	0088381461962	52,00
	Polimento	130		197317-1	0088381461979	48,00

**Boinas de lã dupla** ★★



Ø (mm)	Modelos	Unds.	Código	EAN	P.V.P. (€)
230	9237CB	1	D-70873	0088381557771	18,70

**Boinas de lã com velcro. Polimento de alto brilho** ★★★



Ø (mm)	Unds.	Código	EAN	P.V.P. (€)
100	1	197896-9	0088381468305	18,20
125		197897-7	0088381468329	16,00
150		199424-6	0088381534567	28,00
150		794560-9	0088381149365	24,00
180		192629-7	0088381140690	21,00
180		D-74594	-	13,90

**Boinas de lã** ★★★



794176-0

Ø (mm)	Tipo	Unds.	Código	EAN	P.V.P. (€)
100	Lã	1	794173-6	0088381103848	13,20
180	Cordero		794176-0	0088381117159	24,00

**Feltro (com velcro)**



Ø (mm)	Tipo	Unds.	Código	EAN	P.V.P. (€)	
100	Velcro	1	197895-1	0088381468282	29,00	★★★★★
125			196152-4	0088381413572	26,00	★★★★★
125			D-74631	0088381588218	7,20	★★
150			794618-4	0088381157841	20,00	★★★★★
150			D-74619	0088381588195	9,90	★★
180			D-74625	0088381588201	11,50	★★



**Esponjas de velcro**



D-70786



D-70792



P-21733

Ø (mm)	Tipo	Un ds.	Código	EAN	P.V.P. (€)	
100	-	Liso	197893-5	0088381468244	18,70	★★★
125	-	Liso	794558-6	0088381149358	26,00	★★★
125	-	Liso	D-74653	0088381588300	10,20	★★
150	-	Liso	D-74669	0088381588317	13,10	★★
150	-	Liso	197894-3	0088381468268	22,00	★★★
190	Grosso	Liso	D-70786	0088381556071	18,70	★★
190	Médio	Liso	D-70792	0088381556088	18,70	★★
150	Grosso	Liso	P-21727	0088381948821	15,40	★★★
150	Fino	Liso	P-21733	0088381948838	10,80	★★★



**Esponjas de velcro**

★★



Ø (mm)	Tipo	Un ds.	Código	EAN	P.V.P. (€)
100	Grosso	Liso	D-62505	0088381498142	4,90
125	Grosso	Liso	D-62511	0088381498159	7,00
150	Grosso	Liso	D-62527	0088381498166	8,20
180	Grosso	Liso	D-74572	0088381588157	13,10



100	Médio	Liso	D-62533	0088381498173	4,90
125	Médio	Liso	D-62549	0088381498180	7,00
150	Médio	Liso	D-62555	0088381498197	8,20
180	Médio	Liso	D-74588	0088381588164	13,10



100	Fino	Liso	D-62561	0088381498203	4,90
125	Fino	Liso	D-62577	0088381498210	7,00
150	Fino	Liso	D-62583	0088381498227	8,20
180	Fino	Liso	D-70801	0088381556095	13,10



100	Grosso	Ondulado	D-62599	0088381498234	4,90
125	Grosso	Ondulado	D-62608	0088381498241	7,00
150	Grosso	Ondulado	D-62614	0088381498258	8,20



100	Médio	Ondulado	D-62620	0088381498265	4,90
125	Médio	Ondulado	D-62636	0088381498272	7,00
150	Médio	Ondulado	D-62642	0088381498289	8,20



100	Fino	Ondulado	D-62658	0088381498296	4,90
125	Fino	Ondulado	D-62664	0088381498302	7,00
150	Fino	Ondulado	D-62670	0088381498319	8,20



### Placas perfuradoras

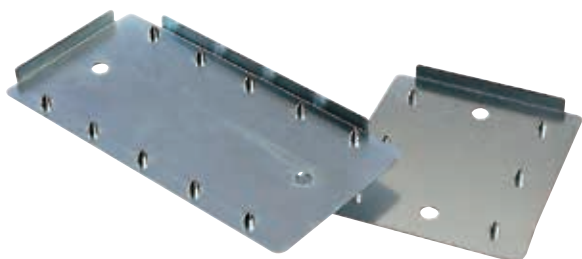

Modelo	Tipo	Unds.	Código	EAN	P.V.P. (€)
BO4553	Metálica	1	413094-0	0088381201025	1,40
BO4556	Plástico	1	450066-4	0088381346085	0,95
BO3711	Metálica	1	192989-7	0088381151160	7,70
9046 BO4900V BO4901	Metálica	1	192523-3	0088381132282	22,00



### Suporte + Saco de papel



Descrição	Modelo	Unds.	Código	EAN	P.V.P. (€)
Suporte + Saco	BO4900V BO5020 BO5021 BO6030 BO9046	1	193294-5	0088381160247	13,20

### Sacos de tecido



Descrição	Modelo	Unds.	Código	EAN	P.V.P. (€)
Tecido vermelho (com adaptador)	9046	1	152456-4	0088381133548	22,00
Tecido vermelho (com adaptador)	BO3700	1	151780-2	0088381156929	2,60
Tecido vermelho (sem adaptador) para 151518-5	BO4901 BO4900V BO6030	1	151517-7*	0088381150859	8,80
Tecido (com adaptador)	BO4556 BO4565 BO4566	1	135222-4	0088381435918	4,90

\* Indicados para caixa de pó.

### Sacos de papel e nylon



Descrição	Modelo	Unds.	Código	EAN	P.V.P. (€)
Papel (11cm)	BO3711 BO4556 BO4565 BO4566 BO5030 BO5031 BO5040 BO5041	5	194746-9*	0088381352017	5,50
Papel (15cm)	BO4553	5	193712-3	0088381181730	6,70
Papel (longo)	BO4900V BO6030 9046	5	193293-7	0088381160254	8,10
Nylon (11cm)	BO4556 BO4565 BO4566	1	168557-8*	3240890313324	2,65

### Caixa de pó



Descrição	Modelo	Unds.	Código	EAN	P.V.P. (€)
Com adaptador e saco de papel pequeno	BO5030 BO5031 BO5040 BO5041	1	135246-0	0088381403528	5,00
Com adaptador e saco de nylon	BO3711 DB0180 DB0380 DB0381	1	135327-0	0088381365611	6,60
Sem adaptador e saco		1	450770-5	-	2,65



### Extensão para DSL800



Descrição	Unds.	Código	EAN	P.V.P. (€)
Conjunto de cabo extensor	1	199937-7	0088381549370	187,00

### Punhos

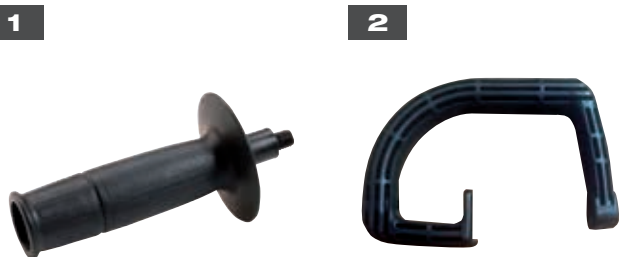

Modelo	Tipo	Descrição	Unds.	Código	EAN	P.V.P. (€)
GV7000C PV7000C	1	Punho	1	152491-2	0088381131605	2,50
9227CB	2	Pega	1	416348-4	0088381201193	11,10
9237CB	2	Pega	1	455293-8		25,00
PO6000C	1	Punho	1	198043-5	0088381473033	9,40
DPO600	1	Punho	1	144163-3	0088381523769	3,50

### Suporte de lixa para 9032



Descrição	Modelo	Unds.	Código	EAN	P.V.P. (€)
Suporte de lixa 6 mm	9032	1	125157-7	0088381164009	63,00
Suporte de lixa 9 mm		1	125158-5	0088381164016	35,00
Suporte de lixa 13 mm		1	125159-3	0088381164023	105,00

### Protetores de plástico



Modelo	Descrição	Unds.	Código	EAN	P.V.P. (€)
9565CLR	Protetor de plástico	1	417322-5	0088381156981	8,10
9227CB		1	417671-0	0088381169424	18,00
9237CB		1	455291-2	-	9,40
SA5040C		1	453378-4	0088381538480	10,40
SA7000C		1	418529-6	0088381191975	3,20

### Protetor de pó 9237C



Modelo	Descrição	Unds.	Código	EAN	P.V.P. (€)
9237C	Evita a entrada de partículas grossas no motor	1	455288-1	3240890404909	3,05

### Acessórios para polidoras



Modelo	Tipo	Descrição	Unds.	Código	EAN	P.V.P. (€)
9227CB PV7000C SA7000C	A	Dispositivo centralizador para acessórios de velcro	1	262542-4	0088381142915	2,35

### Suporte vertical

Modelos	Unds.	Código	EAN	P.V.P. (€)
9032	1	193618-5	0088381173988	35,00



**Grampos de aperto**



Modelos	Unds.	Código	EAN	P.V.P. (€)
9910 9911	2	192694-6	0088381145626	50,00

**Nivelador**



Modelos	Unds.	Código	EAN	P.V.P. (€)
9902 9903	1	193070-7	0088381154369	101,00
9404	1	193072-3	0088381154383	102,00

**Suporte**



Modelos	Unds.	Código	EAN	P.V.P. (€)
9402 9401	1	342332-2	0088381116350	4,10

**Saco coletor de pó para lixadoras de cinta**



Modelos	Unds.	Código	EAN	P.V.P. (€)
9402	1	122297-2	0088381116299	11,60
9403	1	122562-9	0088381148184	14,10
9404 9920	1	122591-2	0088381154239	12,70
9911	1	122548-3	0088381146784	5,80
9924DB	1	122296-4	0088381116282	14,10

**Suporte com guia lateral**

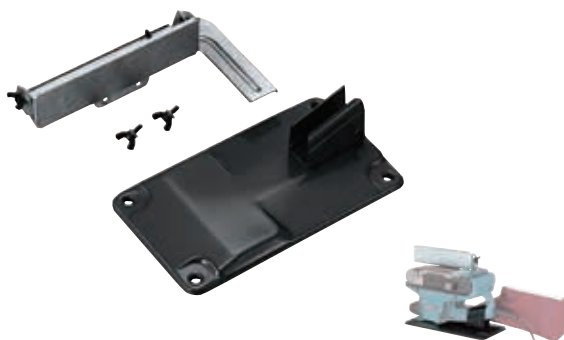

Modelos	Unds.	Código	EAN	P.V.P. (€)
9903 - 9920 - 9404	1	193055-3	0088381151955	87,00
9924DB	1	STEX122299	0088381116336	112,00





# Multifunções



Acessórios para multifunções - Gama Starlock

# STARLOCK



	Referência	Medida (mm)	Dentes por polegada	Material	Madeira					Metal				
					Dente curvo	Madeira	Contraplacado	Aglomerado	Laminado	Placa de gesso	Metal não ferroso	Chapa metálica	Inoxidável	Metal macio
	TMA064	85	18	BiM		✓	✓	✓	✓	✓	✓	✓		✓
	TMA046	100	15	BiM		✓	✓	✓	✓	✓	✓			✓
	TMA049	85	18	HCS		✓	✓	✓	✓					
	TMA045	85	18	BiM		✓	✓	✓	✓	✓	✓	✓		✓
	TMA048	65 x 40	20	BiM	✓	✓	✓	✓	✓	✓	✓	✓		✓
	TMA052	65 x 40	20	HCS	✓	✓	✓	✓	✓					
	TMA047	32 x 50	20	BiM	✓	✓	✓	✓	✓	✓	✓	✓		✓
	TMA051	32 x 50	18	HCS	✓	✓	✓	✓	✓					
	TMA055	65 x 40	14	BiM	✓	✓	✓	✓	✓	✓				
	TMA056	65 x 40	14	HCS	✓	✓	✓							
	TMA053	32 x 50	14	BiM	✓	✓	✓	✓	✓	✓				
	TMA050	24 x 50	18	HCS		✓	✓	✓	✓					
	TMA058	20 x 30	20	BiM		✓	✓	✓	✓	✓	✓	✓		✓
	TMA061	32 x 40	23	TC / HM		✓	✓	✓	✓	✓	✓	✓	✓	✓
	TMA059	32 x 50	20	BiM		✓	✓	✓	✓	✓	✓	✓		✓
	TMA057	10 x 30	20	HCS		✓	✓	✓	✓	✓	✓	✓		✓
	TMA060	20 x 40	23	TC / HM		✓	✓	✓	✓	✓	✓	✓	✓	✓
	TMA054	32 x 50	14	HCS	✓	✓	✓							
	TMA065	52 x 26	-	HCS										
	TMA066	52 x 40	-	HCS										
	TMA063	100	-	BiM										
	TMA067	28 x 40	-	HCS										
	TMA068	11 x 24	-	HCS										
	TMA075	32 x 30	-	TC # 50		✓				✓				
	TMA076	32 x 50	-	TC # 40		✓	✓							
	TMA077	32 x 50	-	TC # 100		✓	✓							
	TMA074	70	-	TC # 40						✓				
	TMA069	85	-	TC # 30						✓				
	TMA070	85	-	TC # 40						✓				
	TMA071	70	-	TC # 50						✓				
	TMA072	85	-	TC # 40						✓				
	TMA073	78	-	TC # 20		✓								



Multimaterial						Abrasivo		
Epóxi	Fibra de vidro	Linóleo	Adesivos	Material isolante	Material de vedação macio	Tijolo macio	Azulejos	Adesivos e argamassas
✓	✓							
✓	✓							
✓								
✓	✓							
✓	✓							
✓	✓							
✓	✓							
✓	✓							
✓								
✓	✓							
✓	✓							
✓	✓							
✓	✓							
✓	✓							
			✓					
			✓					
		✓	✓	✓				
					✓			
		✓	✓	✓				
✓	✓					✓	✓	✓
✓	✓					✓		✓
✓	✓					✓	✓	✓
✓	✓					✓	✓	✓
✓	✓					✓	✓	✓
✓	✓					✓	✓	✓
✓								✓



Acessórios para multifunções - Gama Starlock Máx

# STARLOCK MAX



	Referência	Medida (mm)	Dentes por polegada	Material lâmina	Dente curvo	Madeira					Metal			
						Madeira	Contraplacado	Aglomerado	Laminado	Placa de gesso	Metal não ferroso	Chapa metálica	Inoxidável	Metal macio
	MAM003	100	15	BiM		✓	✓	✓	✓		✓			✓
	MAM011	68	-	Diamante						✓				
	MAM009	68	-	TC # 50						✓				
	MAM010	68	-	TC # 30						✓				
	MAM014	100	-	TC # 40		✓	✓			✓	✓			✓
	MAM005	32	23	TC		✓	✓	✓	✓	✓	✓	✓	✓	✓
	MAM006	32	20	TC	✓	✓	✓	✓	✓	✓	✓	✓	✓	✓
	MAM004	32	18	HCS	✓	✓	✓	✓	✓					
	MAM001	32	20	BiM	✓	✓	✓	✓	✓	✓	✓	✓		✓
	MAM002	52	18	BiM	✓	✓	✓	✓	✓	✓	✓	✓		✓
	MAM008	32	-	HCS										
	MAM007	32	-	HCS										
	MAM015	116	-	TC # 20		✓	✓	✓						
	MAM017	116	-	TC # 60		✓	✓	✓						





Multimaterial						Abrasivo		
Epóxi	Fibra de vidro	Linóleo	Adesivos	Material isolante	Material de vedação macio	Tijolo macio	Azulejos	Adesivos e argamassas
✓								
✓	✓					✓	✓	✓
✓	✓					✓	✓	✓
✓	✓					✓	✓	✓
✓	✓					✓		✓
✓	✓					✓		
✓	✓							
✓	✓							
✓	✓							
				✓	✓			
					✓			
	✓							✓

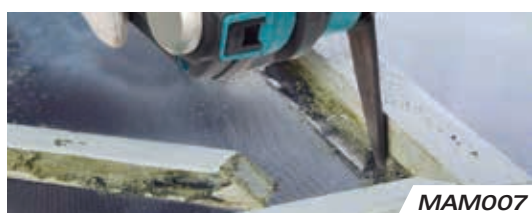

**Acessórios de corte**



**Lâmina de corte segmentada 85 STARLOCK**

**TMA064**

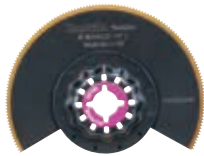

- Metais não ferrosos, FRP, PVC.
- Adequado para esquinas.
- Corte por imersão em placas de gesso cartonado ou de fibrocimento.
- Recortes em fibra de vidro (PRFV)/epóxi.

Ø (mm)	Material / Indicado para	Unds.	Código	EAN	P.V.P. (€)
85	BiM - TiN / Multimaterial	1	B-64973	0088381536479	25,00

**Lâmina de corte segmentada 100 STARLOCK**

**TMA046**



- Madeira e metal.
- Adequado para cortes rentes profundos.
- Caixilhos de portas.
- Parquet/pavimento laminado.

Ø (mm)	Material / Indicado para	Unds.	Código	EAN	P.V.P. (€)
100	BiM / Madeira e Metal	1	B-64808	0088381536301	26,00

**Lâmina de corte segmentada 85 STARLOCK**

**TMA045**



- Madeira e metal.
- Adequado para cortes rentes profundos.
- Caixilhos de portas.
- Parquet/pavimento laminado.

Ø (mm)	Material / Indicado para	Unds.	Código	EAN	P.V.P. (€)
85	BiM / Madeira e Metal	1	B-64799	0088381536295	18,20



**Acessórios de corte por imersão**



**Lâmina de imersão 65 STARLOCK**

**TMA048**



- Madeira e pregos.
- Caixilhos de portas. Cortes por imersão em painéis laminados.

Medida (mm)	Material / Indicado para	Unds.	Código	EAN	P.V.P. (€)
65 x 40	BiM / Madeira e Metal	1	B-64820	0088381536325	19,30

**Lâmina de imersão 65 STARLOCK**

**TMA052**



- Madeira e metal.
- Indicado para cortes à face.
- Parquet/pavimento laminado.
- Cortes de imersão em Madeira.

Medida (mm)	Material / Indicado para	Unds.	Código	EAN	P.V.P. (€)
65 x 40	HCS / Madeira	1	B-64864	0088381536363	14,30

**Lâmina de imersão 32 STARLOCK**

**TMA047**



- Madeira e metal.
- Adequado para corte por imersão preciso.
- Corte por imersão em madeira dura.

Medida (mm)	Material / Indicado para	Unds.	Código	EAN	P.V.P. (€)
32 x 50	BiM / Madeira e Metal	1	B-64814	0088381536318	13,80
32 x 50	BiM / Madeira e Metal (20 Unds.)	20	B-64814-20	0088381541213	226,00

**Lâmina de imersão 32 STARLOCK**

**TMA051**



- Recortes em mobiliário.
- Cortes profundos em madeira macia.
- Cortes por imersão em madeira macia.

Medida (mm)	Material / Indicado para	Unds.	Código	EAN	P.V.P. (€)
32 x 50	HCS / Madeira	1	B-64858	0088381536356	12,10
32 x 50	HCS / Madeira (20 Unds.)	20	B-64858-20	0088381541220	139,00

**Acessórios de corte por imersão**

**Lâmina de imersão 65**



**TMA055**



- Recortes em mobiliário.
- Cortes à face.
- Corte por imersão em painéis laminados ou de madeira dura.



Medida (mm)	Material / Indicado para	Unds.	Código	EAN	P.V.P. (€)
65 x 40	BiM / Madeira	1	B-64892	0088381536394	18,70

**Lâmina de imersão 65**



**TMA056**



- Recortes em mobiliário.
- Cortes à face.
- Corte por imersão em painéis laminados ou madeira.



Medida (mm)	Material / Indicado para	Unds.	Código	EAN	P.V.P. (€)
65 x 40	HCS / Madeira	1	B-64901	0088381536400	15,40

**Lâmina de imersão 32**



**TMA053**



- Madeira dura.
- Recortes em mobiliário.
- Cortes por imersão em madeira dura e painéis laminados.



Medida (mm)	Material / Indicado para	Unds.	Código	EAN	P.V.P. (€)
32 x 50	BiM / Madeira	1	B-64870	0088381536370	12,40
32 X 50	BiM / Madeira	5	B-64870-5	0088381536684	62,00
32 x 50	BiM / Madeira	20	B-64870-20	0088381541237	226,00

**Lâmina de imersão 24**



**TMA050**



- Recortes em mobiliário.
- Cortes rentes em madeira. Cortes profundos em madeira macia.
- Cortes por imersão em madeira macia.



Medida (mm)	Material / Indicado para	Unds.	Código	EAN	P.V.P. (€)
24 x 50	HCS / Madeira	1	B-64842	0088381536349	8,60
24 x 50	HCS / Madeira	5	B-64842-5	0088381588409	43,00



**Lâmina de imersão 20**



**TMA058**



- Metal. Adequado para corte à face em pregos ou tubos de cobre.
- Cortes em rodapés.



Medida (mm)	Material / Indicado para	Unds.	Código	EAN	P.V.P. (€)
20 x 30	BiM / Metal	1	B-64923	0088381536424	9,40

**Lâmina de imersão 32**



**TMA061**



- Corte de aço inoxidável.
- Adequado para corte rente em parafusos e pregos temperados.
- Corte de fibra de vidro.



Medida (mm)	Material / Indicado para	Unds.	Código	EAN	P.V.P. (€)
32 x 40	TC / HM, Metal	1	B-64951	0088381536455	25,00

**Lâmina de imersão 32**



**TMA059**



- Cortes em rodapés.
- Metal. Adequado para corte rente em pregos ou tubos de cobre.



Medida (mm)	Material / Indicado para	Unds.	Código	EAN	P.V.P. (€)
32 x 50	BiM / Metal	1	B-64939	0088381536431	12,10

**Lâmina de imersão 10**



**TMA057**



- Metal. Adequado para corte rente em pregos.
- Cortes por imersão em placas de gesso cartonado.
- Cortes em rodapés.



Medida (mm)	Material / Indicado para	Unds.	Código	EAN	P.V.P. (€)
10 x 30	HCS / Madeira	1	B-64917	0088381536417	8,20



**Lâmina de imersão 20**



**TMA060**



- Corte de aço inoxidável.
- Adequado para corte rente em parafusos e pregos temperados.
- Corte de Fibra de vidro.

Medida (mm)	Material / Indicado para	Unds.	Código	EAN	P.V.P. (€)
20 x 40	TC / HM, Metal	1	B-64945	0088381536448	21,00

**Lâmina de imersão 32**



**TMA054**



- Recortes em mobiliário.
- Cortes por imersão em madeira.

Medida (mm)	Material / Indicado para	Unds.	Código	EAN	P.V.P. (€)
32 x 50	HCS / Madeira	1	B-64886	0088381536387	12,10

**Raspadores**



**Raspador rígido 52**



**TMA065**



- Remover restos de alcatifa, betume...
- Eliminação de resíduos: Adesivo, argamassa e betão.

Medida (mm)	Material / Indicado para	Unds.	Código	EAN	P.V.P. (€)
52 x 26	HCS	1	B-64989	0088381536486	9,60

**Raspador flexível 52**



**TMA066**



- Remoção de resíduos de tinta.
- Retirar juntas de silicone.
- Remoção de resíduos de adesivos de carpetes.

Medida (mm)	Material / Indicado para	Unds.	Código	EAN	P.V.P. (€)
52 x 40	HCS	1	B-64995	0088381536493	9,90

**Lâminas de corte**



**Lâmina segmentada de serra 100**



**TMA063**



- Ideal para materiais de isolamento.
- Corte rente de poliestireno.
- Corte de materiais macios (alcatifa, couro...).

Ø (mm)	Material / Indicado para	Unds.	Código	EAN	P.V.P. (€)
100	BiM	1	B-64967	0088381536462	25,00

**Lâmina de corte 28**



**TMA067**



- Cortar juntas de expansão macias.
- Retirar silicone de janelas.
- Recortar material isolante.

Medida (mm)	Material / Indicado para	Unds.	Código	EAN	P.V.P. (€)
28 x 40	HCS	1	B-65006	0088381536509	17,10

**Lâmina universal multicorte 11**



**TMA068**

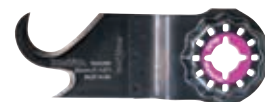

- Cortar juntas de expansão macias.
- Retirar silicone de janelas.
- Recortar material isolante.

Medida (mm)	Material / Indicado para	Unds.	Código	EAN	P.V.P. (€)
11 x 24	HCS	1	B-65012	0088381536516	18,20





**Limpeza e corte**



**Lâmina de limpeza HM 32**



**TMA075**



- Corte por imersão e raspagem em fibra de vidro.
- Remover o betume em cantos apertados ou juntas de cimento.

Medida (mm)	Material / Indicado para	Unds.	Código	EAN	P.V.P. (€)
32 x 30	TC / HM Grão 50	1	B-65084	0088381536585	25,00

**Lâmina de limpeza HM 32**



**TMA076**



- Lixamento de Vernizou tinta em zonas de difícil acesso.
- Lixamento de madeira, compósito de madeira-plástico e epóxi.

Medida (mm)	Material / Indicado para	Unds.	Código	EAN	P.V.P. (€)
32 x 50	TC / HM Grão 40	1	B-65090	0088381536592	22,00

**Lâmina de limpeza HM 32**



**TMA077**



- Lixamento de Vernizou tinta em zonas de difícil acesso.
- Lixamento de madeira, compósito de madeira-plástico e epóxi.

Medida (mm)	Material / Indicado para	Unds.	Código	EAN	P.V.P. (€)
32 x 50	TC / HM Grão 100	1	B-65109	0088381536608	22,00

**Lâmina de limpeza HM**



**TMA074**



- Para levantar argamassa.
- Limpar as juntas dos azulejos do chão.
- Limpeza de juntas de esquinas com a ponta de carboneto de tungstênio.

Medida (mm)	Material / Indicado para	Unds.	Código	EAN	P.V.P. (€)
70	TC / HM Grão 40	1	B-65078	0088381536578	39,00

**Lâmina de limpeza HM 85**



**TMA069**



- Limpeza de juntas em paredes e pisos.
- Pequenos cortes em azulejo macio.
- Realizar roços em betão poroso para cabos e tubagens.

Ø (mm)	Material / Indicado para	Unds.	Código	EAN	P.V.P. (€)
85	TC / HM Grão 40	1	B-65028	0088381536523	28,00

**Lâmina de corte e limpeza de diamante segmentada HM 85**



**TMA070**



- Pequenos cortes em azulejo macio.
- Fazer roços em epóxi, fibra de vidro, pvc, porcelana.

Ø (mm)	Material / Indicado para	Unds.	Código	EAN	P.V.P. (€)
85	TC / HM Grão 40	1	B-65034	0088381536530	45,00

**Lâmina de corte e limpeza segmentada HM 70**



**TMA071**



- Limpeza de juntas em paredes e pisos.
- Pequenos cortes em azulejo macio.
- Realizar roços em betão poroso para cabos e tubagens.

Ø (mm)	Material / Indicado para	Unds.	Código	EAN	P.V.P. (€)
70	TC / HM Grão 50	1	B-65040	0088381536547	25,00

**Lâmina de corte e limpeza segmentada HM 85**



**TMA072**



- Limpeza de juntas em paredes e pisos.
- Pequenos cortes em azulejo macio.
- Realizar roços em betão poroso.

Ø (mm)	Material / Indicado para	Unds.	Código	EAN	P.V.P. (€)
85	TC / HM Grão 40	1	B-65056	0088381536554	24,00



**Lâmina de limpeza**

**Lâmina de limpeza TC HM 78** STARLOCK

**TMA073**



- Remover argamassa ou cola de azulejos.
- Limpar adesivos das carpetes.



Medida (mm)	Material / Indicado para	Unds.	Código	EAN	P.V.P. (€)
78	TC / HM Grão 20	1	B-65062	0088381536561	24,00

**Prato de lixa 93**

STARLOCK

**TMA078**



Medida (mm)	Material / Indicado para	Unds.	Código	EAN	P.V.P. (€)
93	Velcro	1	B-65115	0088381536615	12,10

**Set de Lâminas**

**Set de lâminas de imersão**

**TMA045** Lâmina de corte segmentada 85

**TMA047** Lâmina de imersão 32

**TMA053** Lâmina de imersão 32

**TMA058** Lâmina de imersão 20



Medida (mm)	Material / Indicado para	Unds.	Código	EAN	P.V.P. (€)
-	Cortes por imersão	4	B-67480	0088381541145	48,00

**Set de lâminas para azulejo**

**TMA058** Lâmina de imersão 20

**TMA065** Raspador rígido 52

**TMA069** Lâmina de limpeza HM 85

**TMA073** Lâmina de limpeza TC HM 78



Medida (mm)	Material / Indicado para	Unds.	Código	EAN	P.V.P. (€)
-	Azulejo	4	B-67496	0088381541152	58,00



**Tabela de aplicação - Lixas para multifunções**

		Grão	Pintura	Verniz	Lacas	Gesso	Madeira	Madeira macia	Madeira dura	Contraplacado de madeira	Aglomerado / MDF	Fibra de vidro / Plásticos	Metal	Aço	Pedra	Mármore	Granito	Vidro	Metacrilato
Madeira / long life	Grosso	60																	
		80																	
	Médio	100				✓	✓	✓	✓	✓	✓	✓							
		120	-	-	-	-	✓	✓	✓	✓	✓	✓	✓						
	Fino	180																	
	240																		
Madeira	Grosso	60																	
		80																	
	Médio	100				✓	✓	✓	✓	✓	✓								
		120	-	-	-	-	✓	✓	✓	✓	✓								
	Fino	150																	
	180																		
	240																		
Pintura	Grosso	60																	
		80																	
	Médio	100	✓	✓	✓	✓						✓	✓						
		120	✓	✓	✓	✓						✓	✓						
	Fino	240																	
	320																		
Pedra	Médio	120																	
		240																	
	Fino	400	✓	✓							✓			✓	✓	✓	✓	✓	✓
		600																	
	Muito fino	1200																	

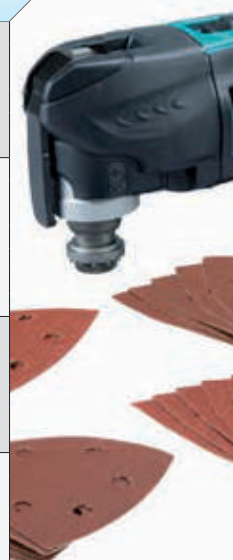

**Lixas**

**Lixas para madeira**

- Adequado para lixar madeira, madeira dura, aglomerado, painéis de construção e metal.



Medida (mm)	Tipo	Grão	Unds.	Código	EAN	P.V.P. (€)
93 x 93 x 93	Madeira	60	10	B-21624	0088381401081	3,90
		80	10	B-21630	0088381401098	3,60
		100	10	B-22947	0088381403344	3,60
		120	10	B-21646	0088381401104	3,60
		150	10	B-22953	0088381403351	3,60
		180	10	B-21652	0088381401111	3,60
		240	10	B-21668	0088381401128	3,60
		60, 80, 120, 180, 240	10 (2 de cada)	B-21618	0088381401074	4,20

**Lixas para tinta e verniz**

- Adequadas para lixar tinta, verniz ou retificar.



Medida (mm)	Tipo	Grão	Unds.	Código	EAN	P.V.P. (€)
93 x 93 x 93	Pintura	60	10	B-21680	0088381401142	4,10
		80	10	B-21696	0088381401159	4,10
		100	10	B-21705	0088381401166	4,10
		120	10	B-22969	0088381403368	4,10
		240	10	B-21711	0088381401173	4,10
		320	10	B-21727	0088381401180	4,10
		60, 80, 100, 240, 320	10 (2 de cada)	B-21674	0088381401135	4,40

**Abrasivo de lã para remover ferrugem do metal e sujidade da madeira**

- Adequado para remover ferrugem do metal e sujidade da madeira.



Medida (mm)	Tipo	Grão	Unds.	Código	EAN	P.V.P. (€)
93 x 93 x 93	Lana	100	1	B-21808	0088381401265	3,30
		280	1	B-21799	0088381401258	3,30
		Sin Grão	1	B-21814	0088381401272	3,30

**Kit de aspiração**



Modelo	Unds.	Código	EAN	P.V.P. (€)
TM3000C	1	199618-3	0088381545303	7,00
TM3010C	1	199624-8	0088381545297	8,80
DTM51	1	199627-2	0088381545327	11,50
DTM52	1	191R02-6	0088381580564	12,00

**Lixas para madeira dura, painéis de obra e metal**

- Adequado para trabalhos em madeira, plástico, metal em chapas, madeira envernizada e metal pintado.



Medida (mm)	Tipo	Grão	Unds.	Código	EAN	P.V.P. (€)
93 x 93 x 93	Madeira dura	40	10	P-33255	0088381961417	4,10
		60	10	P-33261	0088381961424	4,10
		80	10	P-33277	0088381961431	4,10
		100	10	P-33283	0088381961448	3,90
		120	10	P-33299	0088381961455	3,90
		180	10	P-33314	0088381961479	3,90
		240	10	P-33320	0088381961486	3,90
		60, 80, 100, 120, 180	10 (2 de cada)	B-21559	0088381401012	4,40

**Lixas para materiais duros como pedra, mármore ou vidro**

- Adequado para lixamento grosseiro ou brilhante de materiais duros como pedra, mármore ou vidro.



Medida (mm)	Tipo	Grão	Unds.	Código	EAN	P.V.P. (€)
93 x 93 x 93	Pedra	120	10	B-21749	0088381401203	4,10
		240	10	B-21755	0088381401210	4,10
		400	10	B-21761	0088381401227	4,10
		600	10	B-21777	0088381401234	3,90
		1200	10	B-21783	0088381401241	3,90
		120, 240, 400, 600, 1200	10 (2 de cada)	B-21733	0088381401197	4,40

**Feltro para pré-polimento de superfícies sujas ou arranhadas**

- Feltro para pré-polimento de superfícies sujas ou arranhadas.



Medida (mm)	Tipo	Grão	Unds.	Código	EAN	P.V.P. (€)
93 x 93 x 93	Fieltro	Duro	1	B-21820	0088381401289	3,30

**Adaptador universal**



Unds.	Código	EAN	P.V.P. (€)
1	313248-8	0088381416528	2,80

# STARLOCK MAX



## Acessórios de corte

### L. de corte segmentada 100

STARLOCK MAX

#### MAM003



- Adequada para cortes retos longos, cortes profundos e largos em madeira e metal.
- Também pode cortar epóxi e fibra de vidro.

Medida (mm)	Material / Indicado para	Unds.	Código	EAN	P.V.P. (€)
100 x 50	BiM / Madeira e metal	1	B-66422	0088381539326	25,00

## Acessórios de corte por imersão



### Lâmina de imersão curva 32

STARLOCK MAX

#### MAM006



- Adequada para corte por imersão de precisão, corte profundo e rápido em vários materiais.
- Também pode cortar madeira, epóxi, fibra de vidro e betão poroso.

Medida (mm)	Material / Indicado para	Unds.	Código	EAN	P.V.P. (€)
32 x 70	TC / HM, Multimaterial	1	B-66450	0088381539357	26,00

### Lâmina de imersão 32

STARLOCK MAX

#### MAM005



- Adequada para corte por imersão, corte profundo e rápido em metal.
- Também pode cortar epóxi, fibra de vidro, betão poroso e madeira.

Medida (mm)	Material / Indicado para	Unds.	Código	EAN	P.V.P. (€)
32 x 70	TC / HM, Metal	1	B-66444	0088381539340	25,00

### Lâmina de imersão curva 32

STARLOCK MAX

#### MAM004



- Adequada para corte por imersão preciso, corte profundo e rápido em madeira.
- Não pode ser usada para cortar outros materiais.

Medida (mm)	Material / Indicado para	Unds.	Código	EAN	P.V.P. (€)
32 x 80	HCS / Madeira	1	B-66438	0088381539333	10,80

### Lâmina de imersão curva 52

STARLOCK MAX

#### MAM002

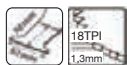

- Adequada para o corte por imersão de precisão, corte profundo e largo especialmente em madeira e metal.
- Também pode cortar epóxi e fibra de vidro.

Medida (mm)	Material / Indicado para	Unds.	Código	EAN	P.V.P. (€)
52 x 70	BiM / Madeira e metal	1	B-66416	0088381539319	14,90

### Lâmina de imersão curva 32

STARLOCK MAX

#### MAM001



- Adequada para o corte por imersão de precisão, corte profundo e rápido especialmente em madeira e metal.
- Também pode cortar epóxi e fibra de vidro.

Medida (mm)	Material / Indicado para	Unds.	Código	EAN	P.V.P. (€)
32 x 80	BiM / Madeira e metal	1	B-66400	0088381539302	13,80

**Lâminas de corte de juntas**



**Lâmina de corte de juntas 32 STARLOCK MAX**

**MAM008**



- Adequada para corte de juntas macias, corte profundo e largo.
- Não é possível cortar noutro material.

Medida (mm)	Material / Indicado para	Unds.	Código	EAN	P.V.P. (€)
32 x 55	HCS / juntas macias	1	B-66472	0088381539371	7,20



**Lâmina de corte de juntas 32 STARLOCK MAX**

**MAM007**



- Adequada para corte de juntas macias, corte profundo e rápido.
- Não é possível cortar outros materiais.

Medida (mm)	Material / Indicado para	Unds.	Código	EAN	P.V.P. (€)
32 x 70	HCS / Juntas macias	1	B-66466	0088381539364	14,30

**Lâminas de diamante**



**L. de corte segmentada 68 STARLOCK MAX**

**MAM011**



- Adequada para o recorte de ladrilhos de parede macios.
- Também pode cortar gesso, epóxi e fibra de vidro.

Medida (mm)	Material / Indicado para	Unds.	Código	EAN	P.V.P. (€)
68 x 30	Diamante Grão 40, corte de ladrilhos e azulejos de parede	1	B-66519	0088381539418	41,00



**Lâminas de corte para azulejos**



**L. de corte segmentada 68** STARLOCK MAX

**MAM009**



- Adequada para cortar juntas em azulejos de parede.
- Também pode cortar em gesso cartonado, epóxi e fibra de vidro.

Medida (mm)	Material / Indicado para	Unds.	Código	EAN	P.V.P. (€)
68 x 10	TC/HM Grão 50, juntas de azulejos de parede	1	B-66494	0088381539395	30,00

**L. de corte segmentada 68** STARLOCK MAX

**MAM010**



- Adequada para cortar juntas em azulejos de parede.
- Capaz de cortar outros materiais como gesso cartonado, epóxi, fibra de vidro.

Medida (mm)	Material / Indicado para	Unds.	Código	EAN	P.V.P. (€)
68 x 30	TC/HM Grão 30, juntas de azulejos de parede	1	B-66503	0088381539401	30,00

**L. de corte segmentada 100** STARLOCK MAX

**MAM014**



- Adequada para cortar juntas em azulejos de parede.
- Também pode ser cortado em madeira, epóxi e fibra de vidro.

Medida (mm)	Material / Indicado para	Unds.	Código	EAN	P.V.P. (€)
100 x 50	TC / HM Grão 40, juntas de azulejos de parede	1	B-66547	0088381539449	29,00



**Limpeza e corte**



**Lâmina de limpeza 116** STARLOCK MAX

**MAM015**

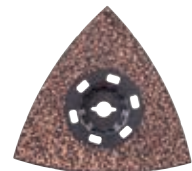

- Adequada para limpar azulejos de parede.
- Também pode limpar madeira e fibra de vidro.

Ø (mm)	Material / Indicado para	Unds.	Código	EAN	P.V.P. (€)
116	TC/HM Grão 20, limpeza de azulejos	1	B-66553	0088381539456	22,00



**Lâmina de limpeza 116** STARLOCK MAX

**MAM017**



- Adequada para limpar madeira.
- Também pode limpar derivados de madeira.

Ø (mm)	Material / Indicado para	Unds.	Código	EAN	P.V.P. (€)
116	TC / HM Grão 60, limpeza de madeira	1	B-66575	0088381539470	22,00



# Serras

- Circulares
- Esquadria
- Incisão

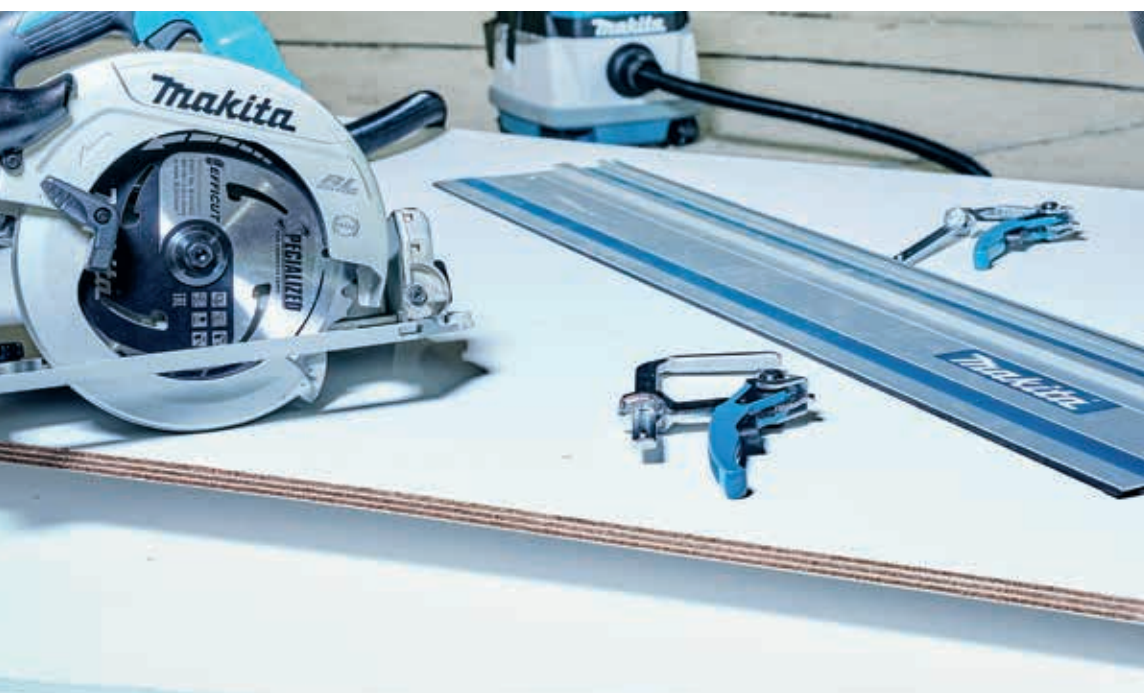

**M**FORCE™

**S**PECIALIZED

**E**FFICUT



**Tipos de dentado**

**ATB**

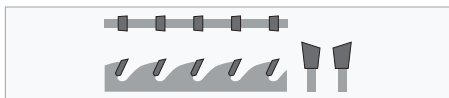
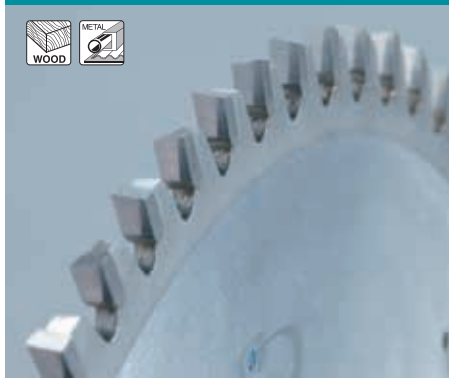

**ATAF**

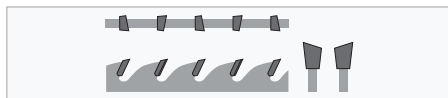

**M-FORCE**

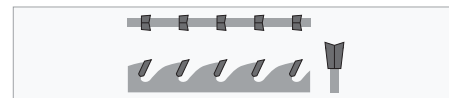

**FTG**

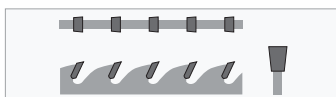

**TCG**

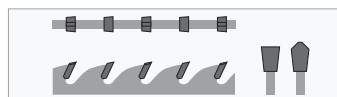
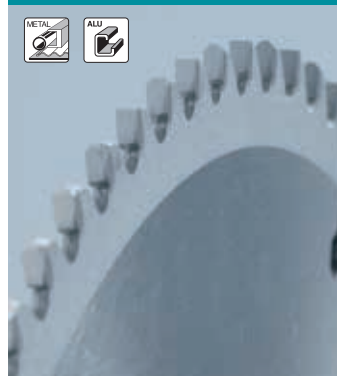

**SMTCG**

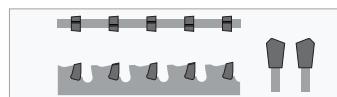

**HI - ATB**

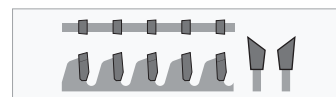

**Tecnologia**

**Fenda a laser**

Láser slit

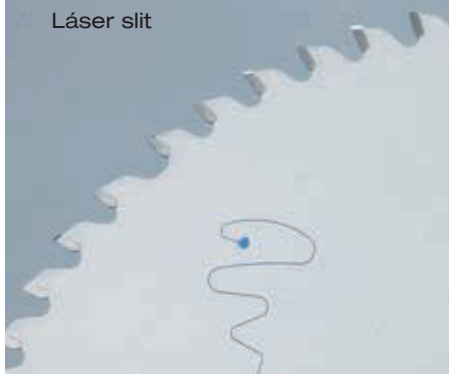

Reduz o ruído e as vibrações.

**Revestido**



O revestimento de PTFE (politetrafluoroetileno) reduz a acumulação de sujidade e diminui a resistência sobre o material.































**Reforçado**





















O desenho de dente embutido aumenta a superfície de aderência para suportar trabalhos mais duros.



Tipos de discos para serras circulares, serras de esquadria e serras de incisão

		85 mm	136 mm	165 mm	185 mm	190 mm	210 mm	235 mm	270 mm	355 mm
<b>MAKFORCE</b>				Uma extensa seleção de lâminas para todas as marcas e modelos de serras circulares portáteis. Ampla gama de medidas, de 160 mm a 355 mm, e número de dentes de 12 a 60. A gama abrange um grande número de aplicações, desde o corte grosseiro e transversal até ao corte fino e longitudinal.						
		-	-	160 mm	170 mm	180 mm	230 mm	✓	✓	✓
<b>SPECIALIZED REFORZADO</b>				Concebidos para serras circulares da Makita e de outros fabricantes de serras, os dentes reforçados ou "dentes embutidos" são especialmente resistentes e de baixo desgaste. Para cortes fáceis em madeira nodosa. Concebido para evitar que os dentes saltem quando os pregos são acidentalmente cortados na madeira. Especialmente adequado para trabalhos de recuperação e demolição de madeira.						
		-	-	✓	✓	✓	✓	✓	✓	✓
<b>MFORCE</b>				Design avançado e revolucionário para serras circulares. A face dupla biselada tem um corte fino e o desenho em "M" faz o efeito de dente duplo. Uma superfície de corte de dentes maior significa uma vida mais longa do que os discos tradicionais. Um corte estreito e um dente estreito reduz o atrito e, assim, reduz o aumento da corrente, protegendo o motor da sua serra. Corte em madeira com pregos e nós acidentais.						
		-	-	✓	✓	-	-	✓	-	-
<b>SPECIALIZED STANDARD</b>				Concebido para serras circulares Makita e outros fabricantes de serras.						
		-	-	✓	✓	-	✓	✓	-	-
<b>SPECIALIZED STANDARD economy</b>				Concebido para serras circulares Makita e outros fabricantes de serras. Cortes em madeira macia. Excelente relação custo-benefício.						
		-	-	✓	✓	✓	-	✓	-	-
<b>SPECIALIZED ALUMINIO</b>				Ampla gama de lâminas de serra circular com excelente desempenho de corte em alumínio, latão, bronze e outros metais não ferrosos. Os discos também são adequados para trabalhar com plásticos e madeira laminada. Aplique cera de disco na área do dente frequentemente para evitar a acumulação de aparas nos dentes ao cortar metais não ferrosos.						
		-	-	160 mm	-	✓	✓	✓	-	360 mm
<b>SPECIALIZED CONSTRUCCION</b>				Estes discos são adequados para madeiras de construção, madeiras de cofragem, madeiras com pregos, madeiras prensadas, madeiras com resíduos de betão.						
		-	-	-	✓	✓	✓	✓	-	-
<b>SPECIALIZED PANEL SANDWICH</b>				Lâminas dentadas HM para corte de painel sanduiche específico. Dente em forma triangular em oposição. Reduz a rebarba na peça de trabalho. Evita a rutura do disco. Ranhuras para evitar vibrações e ruídos. O dente está embutido no disco.						
		-	-	✓	-	-	-	✓	✓	✓
<b>SPECIALIZED MAQUINAS DE BATERIA</b>				Os discos de qualidade superior são especialmente feitos para serras a bateria. Lâminas de corte de madeira agora disponíveis para as mais populares serras circulares sem fio. "Tudo com a qualidade Makita".						
		✓	✓	✓	-	✓	-	✓	-	-
<b>SPECIALIZED INCISION</b>				Estes discos são específicos para serras de incisão. Eles são projetados especificamente para conseguir um corte completamente limpo. Os discos para serras de incisão têm uma tecnologia patenteada contra as vibrações.						
		-	-	160 mm	-	-	-	-	-	-

		136 mm	165 mm	190 mm	216 mm	250 mm	260 mm	300 mm	305 mm	315 mm
<b>MAKBLADE PLUS</b>				Os discos MAKBLADE PLUS têm uma tecnologia única e patenteada. Estes discos são desenvolvidos para atenuar as vibrações e ruídos. Estes discos característicos melhoram o ambiente de trabalho e aumentam a durabilidade da lâmina e a confiabilidade da máquina como um todo. A vida útil dos dentes é significativamente prolongada por se cuidar melhor dos seus discos de carboneto de tungstênio do que os discos convencionais.						
		-	-	✓	-	✓	-	-	-	-
<b>MAKBLADE</b>				Uma extensa seleção de lâminas para todas as marcas e modelos de serras de esquadria. Ampla gama de tamanhos de 190 mm a 305 mm e número de dentes de 24 a 100. A gama abrange um grande número de aplicações, desde o corte grosseiro até ao corte extrafino.						
		-	-	✓	✓	✓	255 mm	260 mm	✓	-
<b>SPECIALIZED ALUMINIO</b>				Chapas metálicas esticadas de precisão para maior rigidez e cortes mais retos. Excelente qualidade de corte em materiais não ferrosos. Perfeito desempenho de corte em pisos laminados. Aplique cera de disco na área do dente frequentemente para evitar a acumulação de aparas nos dentes ao cortar metais não ferrosos.						
		-	-	✓	✓	-	✓	-	✓	350 mm
<b>SPECIALIZED S. MESA</b>				Concebidos para serras de mesa Makita e outros fabricantes de serras. Adequados para madeira.						
		-	-	-	210 mm	-	✓	-	-	✓
<b>SPECIALIZED S. MESA</b>				Concebidos para serras de mesa Makita e outros fabricantes de serras. Adequados para o alumínio.						
		-	-	-	-	-	✓	✓	-	350 mm
<b>SPECIALIZED LAMINADOS</b>				Excelente qualidade de corte em pisos laminados. Alta precisão de corte em molduras e rodapés.						
		✓	✓	✓	✓	-	✓	-	✓	-

# EFFICUT

IDEAL FOR C  
CIRCUL

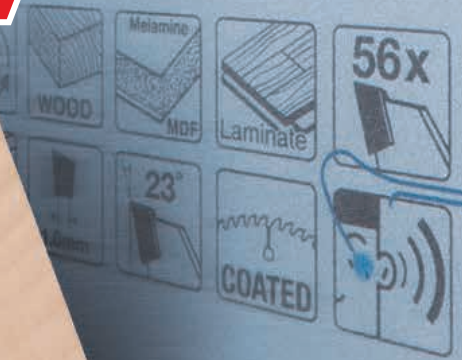

## Características do tipo de dente EFFICUT



Canto superior agudo



Possibilita um corte fino sem esforço.



Corpo curvo



Permite uma evacuação muito eficiente da aparta.



Base retificada



Prolonga a vida útil da bateria, uma vez que é necessário menos esforço para cada corte.

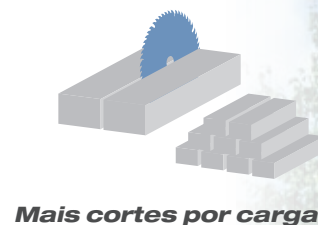

Mais cortes por carga



Cortes rápidos



Maior duração da bateria

Lâmina: 1,6 mm

Número de cortes com uma carga



165mm x 48T

Lâmina: 1,0 mm



EFFICUT 165mm x 50T

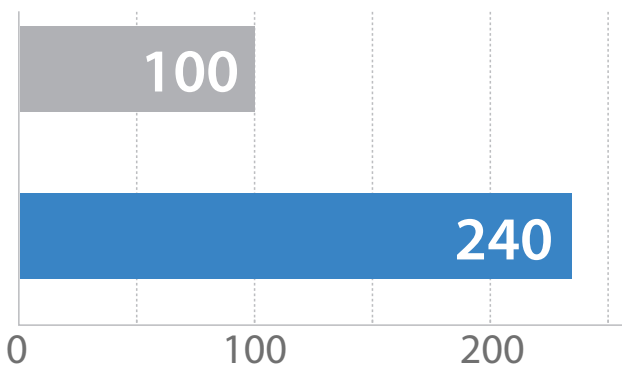

**x2,4  
MAIS VEZES**

- Os resultados dos testes dependem em grande parte da dureza da madeira, etc.
- Os gráficos de barras do número de cortes são valores relativos quando a capacidade (espessura) da lâmina atual: 1,6 mm) é 100.

**CORDLESS  
CIRCULAR SAWS**



**Discos de serra para serras circulares**

**Discos Makforce**



Uma extensa seleção de lâminas para todas as marcas e modelos de serras circulares portáteis.

Ampla gama de medidas, de 160 mm a 355 mm, e número de dentes de 12 a 60. A gama abrange um grande número de aplicações, desde o corte grosseiro e transversal até ao corte fino e longitudinal.

- A estrutura do disco é feita de aço tensionado de precisão, que absorve impactos sem deformação.
- Carboneto de tungstênio de alta qualidade e baixo desgaste para uma longa vida útil da serra.
- Perfeita nitidez para cortes mais precisos.
- Corte fino, com menos aparas e menos esforço no motor.

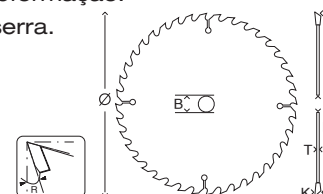

**Ø 165mm DHS660 - DHS661 - DHS680 - DSS610 - HS6100 - HS6601**

Ø ext. (mm)	Ø int. (mm)	K (mm)	T (mm)	Nº dentes	R	Tipo de dente	Redução	Código	EAN	P.V.P (€)
160	20	2,4	1,5	16	20°	ATB	15,88	B-32091	0088381420907	20,00
160	20	2,4	1,5	24	20°	ATB	15,88	B-32203	0088381421010	24,00
160	20	2,4	1,5	40	20°	ATB	15,88	B-32297	0088381421102	29,00
165	20	2,4	1,5	10	20°	FTG	-	B-32100	0088381420914	24,00
170	30	2,4	1,5	16	20°	ATB	15,88	B-32122	0088381420938	22,00
170	30	2,4	1,5	24	20°	ATB	15,88	B-32225	0088381421034	25,00
170	30	2,4	1,5	40	20°	ATB	15,88	B-32312	0088381421126	27,00

**Ø 190mm DHS710 - DHS782 - DHS783 - HS7601 - HS7100 - HS7101 - M5802B - HS004G**

180	20	2,4	1,5	24	20°	ATB	-	B-08327	0088381336314	23,00
190	30	2	1,4	12	20°	FTG	20/15,88	B-32144	0088381420952	25,00
190	30	2,2	1,4	24	20°	ATB	20/15,88	B-32247	0088381421058	26,00
190	30	2,2	1,4	40	20°	ATB	20/15,88	B-32340	0088381421157	34,00
190	30	2,2	1,4	60	15°	ATAF	20/15,88	B-32390	0088381421201	37,00

**Ø 210mm 5008MG**

210	30	2,4	1,6	16	20°	ATB	-	B-32150	0088381420969	25,00
210	30	2,4	1,6	24	20°	ATB	-	B-32253	0088381421065	31,00
210	30	2,4	1,6	40	20°	ATB	-	B-32356	0088381421164	36,00

**Ø 235mm 5903R - 5903RK - DHS900 - HS009G**

235	30	2,3	1,6	20	20°	ATB	-	B-32269	0088381421072	26,00
235	30	2,6	1,6	40	20°	ATB	-	B-32362	0088381421171	32,00
235	30	2,8	1,8	60	15°	ATAF	-	B-32415	0088381421225	34,00

**Ø 270mm 5103R - HS0600 - HS011G**

270	30	2,6	1,8	24	20°	ATB	-	B-32172	0088381420983	40,00
270	30	2,6	1,6	40	20°	ATB	-	B-32378	0088381421188	46,00
270	30	2,8	1,8	60	15°	ATAF	-	B-32409	0088381421218	50,00

**Ø 355mm 5143R**

355	30	3,0	2,2	24	20°	ATB	-	B-32188	0088381420990	56,00
355	30	3,0	2,2	40	20°	ATB	-	B-32281	0088381421096	63,00
355	30	3,0	2,2	60	20°	ATB	-	B-32384	0088381421195	67,00



WOOD

Discos de serra para serras circulares

Discos Specialized Reforçado



Concebidos para serras circulares da Makita e de outros fabricantes de serras, os dentes reforçados ou “dentes embutidos” são especialmente resistentes e de baixo desgaste.

Para cortes fáceis em madeira nodosa. Concebido para evitar que os dentes saltem quando os pregos são acidentalmente cortados na madeira.

Especialmente adequado para trabalhos de recuperação e demolição de madeira.

- Corte em madeira com pregos e nós acidentais.
- Extremamente resistente e de baixo desgaste.
- Aumentam a vida útil da serra e a produtividade.
- Corte fino, com menos aparas e menos esforço no motor.

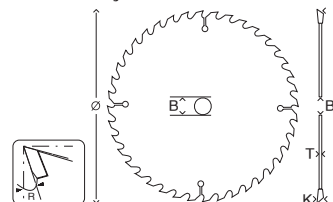

**Ø 165mm DHS660 - DHS661 - DHS680 - DSS610 - HS6100 - HS6601**

Ø ext. (mm)	Ø int. (mm)	K (mm)	T (mm)	Nº dentes	R	Tipo de dente	Redução	Código	EAN	P.V.P (€)
165	20	2	1,25	16	23°	ATB Reforçado	-	B-33037	0088381421904	28,00
165	20	2	1,25	24	23°	ATB Reforçado	-	B-33093	0088381421966	32,00
165	20	2	1,25	40	18°	ATB Reforçado	-	B-33168	0088381422031	36,00

**Ø 190mm DHS710 - DHS782 - DHS783 - HS7601 - HS7100 - HS7101 - M5802B - HS004G**

185	30	2	1,25	16	25°	ATB Reforçado	-	B-33043	0088381421911	22,00
185	30	2	1,25	40	25°	ATB Reforçado	-	B-33174	0088381422048	29,00
190	30	2	1,25	16	23°	ATB Reforçado	-	B-33059	0088381421928	22,00
190	30	2	1,25	24	23°	ATB Reforçado	-	B-33118	0088381421980	31,00
190	30	2	1,25	40	23°	ATB Reforçado	-	B-33180	0088381422055	41,00

**Ø 210mm 5008MG**

210	30	1,9	1,4	18	23°	ATB Reforçado	-	B-33065	0088381421935	27,00
-----	----	-----	-----	----	-----	---------------	---	---------	---------------	-------

**Ø 235mm 5903R - 5903RK - DHS900 - HS009G**

235	30	2,3	1,6	24	23°	ATB Reforçado	-	B-33130	0088381422000	33,00
235	30	2,3	1,6	48	18°	ATB Reforçado	-	B-33196	0088381422062	51,00

**Ø 270mm 5103R - HS0600 - HS011G**

270	30	2,6	1,8	24	23°	ATB Reforçado	-	B-33146	0088381422017	64,00
270	30	2,6	1,8	40	18°	ATB Reforçado	-	B-33205	0088381422079	79,00
270	30	2,6	1,8	60	18°	ATB Reforçado	-	B-33211	0088381422086	80,00

**Ø 355mm 5143R**

355	30	3	2,2	24	23°	ATB Reforçado	-	B-33087	0088381421959	87,00
355	30	3	2,2	60	18°	ATB Reforçado	-	B-33227	0088381422093	114,00



**Discos de serra para serras circulares**

**Discos MForce**



Design avançado e revolucionário para serras circulares.

A face dupla biselada tem um corte fino e o desenho em “M” faz o efeito de dente duplo.

Uma superfície de corte de dentes maior significa uma vida mais longa do que os discos tradicionais. Um corte estreito e um dente estreito reduz o atrito e, assim, reduz o aumento da corrente, protegendo o motor da sua serra. Corte em madeira com pregos e nós acidentais.

- Acabamento perfeito, já que o número de dentes em M é multiplicado por 2.
- Corte agressivo.
- Maior área de trabalho.
- Mais duradouro.

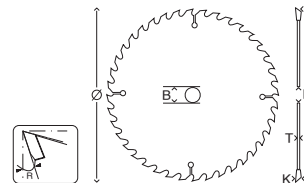

**Ø 165mm DHS660 - DHS661 - DHS680 - DSS610 - HS6100 - HS6601**

Ø ext. (mm)	Ø int. (mm)	K (mm)	T (mm)	Nº dentes	R	Tipo de dente	Redução	Código	EAN	P.V.P (€)
165	20	2	1,2	16	15°	M-Force	-	B-31930	0088381420747	15,70
165	20	2	1,2	24	15°	M-Force	-	B-32007	0088381420815	19,20

**Ø 190mm DHS710 - DHS782 - DHS783 - HS7601 - HS7100 - HS7101 - M5802B - HS004G**

185	30	2	1,2	24	15°	M-Force	20/15,88	B-32035	0088381420846	22,00
-----	----	---	-----	----	-----	---------	----------	---------	---------------	-------

**Ø 235mm 5903R - 5903RK - DHS900 - HS009G**

235	30	2,3	1,6	40	15°	M-Force	25/15,88	B-32085	0088381420891	34,00
-----	----	-----	-----	----	-----	---------	----------	---------	---------------	-------



**Discos Specialized Standard**



Concebido para serras circulares Makita e outros fabricantes de serras.

**Ø 165mm DHS660 - DHS661 - DHS680 - DSS610 - HS6100 - HS6601**

Ø ext. (mm)	Ø int. (mm)	K (mm)	T (mm)	Nº dentes	R	Tipo de dente	Redução	Código	EAN	P.V.P (€)
165	20	2,4	1,5	10	20°	ATB	-	D-03327	0088381173667	12,30
165	20	2,0	1,5	16	20°	ATB	-	D-52554	0088381444422	13,50
165	20	2,4	1,5	24	20°	ATB	-	D-03333	0088381173674	14,70
165	20	2,4	1,5	40	18°	ATB	-	D-03349	0088381173681	17,80

**Ø 190mm DHS710 - DHS782 - DHS783 - HS7601 - HS7100 - HS7101 - M5802B - HS004G**

185	30	1,8	1,2	16	20°	ATB	20	D-03903	0088381174336	13,50
185	30	2,0	1,2	20	20°	ATB	30/20	D-09634	0088381184823	14,70
185	30	1,8	1,2	40	18°	ATB	20	D-03919	0088381174343	16,50

**Ø 210mm 5008MG**

210	30	2,0		24	20°	ATB	-	D-29050	0088381343466	25,00
-----	----	-----	--	----	-----	-----	---	---------	---------------	-------

**Ø 235mm 5903R - 5903RK - DHS900 - HS009G**

235	30	2,3	1,6	20	20°	ATB	25	D-03925	0088381174350	21,00
235	30	2,3	1,6	48	18°	ATB	25	D-03931	0088381174367	25,00
235	30	2,3	1,6	60	15°	ATB	25	D-09640	0088381184830	31,00



Discos de serra para serras circulares

Discos Specialized Standard Economy



- Concebido para serras circulares Makita e outros fabricantes de serras.
- Cortes em madeira macia.
- Excelente relação custo-benefício.

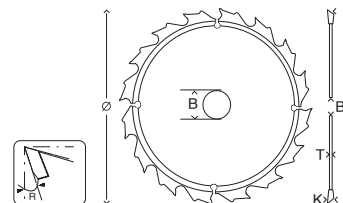

**Ø 165mm DHS660 - DHS661 - DHS680 - DSS610 - HS6100 - HS6601**

Ø ext. (mm)	Ø int. (mm)	K (mm)	T (mm)	Nº dentes	R	Tipo de dente	Redução	Código	EAN	P.V.P (€)
165	20	2,0	1,2	16	12°	ATB	-	D-52554	0088381444422	7,70
165	20	2,0	1,2	24	12°	ATB	-	D-52560	0088381444439	9,00
165	20	2,0	1,2	40	12°	ATB	-	D-52576	0088381444446	11,00

**Ø 190mm DHS710 - DHS782 - DHS783 - HS7601 - HS7100 - HS7101 - M5802B - HS004G**

185	30	2,2	1,4	16	18°	ATB	-	D-52582	0088381444453	9,70
185	30	2,2	1,4	24	15°	ATB	-	D-52598	0088381444460	11,00
185	30	2,2	1,4	40	14°	ATB	-	D-52607	0088381444477	12,30

**Ø 190mm DHS710 - DHS782 - DHS783 - HS7601 - HS7100 - HS7101 - M5802B - HS004G**

190	30	2,2	1,4	24	15°	ATB	-	D-64951	0088381533096	11,30
190	30	2,2	1,4	40	15°	ATB	-	D-64967	0088381533102	12,90
190	30	2,0	1,4	40	18°	ATB	-	D-64973	0088381533119	15,40

**Ø 210mm - 5008MG**

210	30	2,5	1,6	24	15°	ATB	-	D-72291	0088381569026	14,00
210	30	2,5	1,6	40	15°	ATB	-	D-72300	0088381569033	15,20

**Ø 235mm 5903R - 5903RK - DHS900 - HS009G**

235	30	2,5	1,6	20	14°	ATB	-	D-52613	0088381444484	16,70
235	30	2,5	1,6	40	12°	ATB	-	D-52629	0088381444491	19,40
235	30	2,5	1,6	60	12°	ATB	-	D-52635	0088381444507	22,00



Makita

**Discos de serra para serras circulares**

**Discos Specialized Alumínio**



Ampla gama de lâminas de serra circular com excelente desempenho de corte em alumínio, latão, bronze e outros metais não ferrosos. Os discos também são adequados para trabalhar com plásticos e madeira laminada. Aplique cera de disco na área do dente frequentemente para evitar a acumulação de aparas nos dentes ao cortar metais não ferrosos.

- A estrutura do disco é de aço tensionado de precisão para maior rigidez e cortes mais retos.
- Excelente qualidade de corte em materiais não ferrosos.
- Perfeito desempenho de corte em pisos laminados.

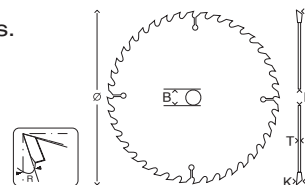

**Ø 165mm DHS680 - DHS660 - DHS661 - DSS610 - HS6601 - HS6100**

Ø ext. (mm)	Ø int. (mm)	K (mm)	T (mm)	Nº dentes	R	Tipo de dente	Redução	Código	EAN	P.V.P (€)
160	20	2,4	1,8	60	0°	TCG	-	B-33233	0088381422109	42,00

**Ø 190mm DHS710 - DHS782 - DHS783 - HS7601 - HS7100 - HS7101 - M5802B - HS004G**

190	30	2,4	1,8	60	0°	TCG	20/15,88	B-33261	0088381422130	59,00
-----	----	-----	-----	----	----	-----	----------	---------	---------------	-------

**Ø 210mm 5008MG**

210	30	2,8	2	54	-5°	TCG	25	B-33548	0088381422437	59,00
-----	----	-----	---	----	-----	-----	----	---------	---------------	-------

**Ø 235mm 5903R - 5903RK - DHS900 - HS009G**

235	30	2,4	1,8	80	0°	TCG	-	B-33277	0088381422147	67,00
-----	----	-----	-----	----	----	-----	---	---------	---------------	-------

**Ø 350mm**

350	30	3,2	2,6	100	0°	TCG	-	B-33401	0088381422284	108,00
-----	----	-----	-----	-----	----	-----	---	---------	---------------	--------



**Discos Specialized Construção**



Estes discos são adequados para madeiras de construção, madeiras de cofragem, madeiras com pregos, madeiras prensadas, madeiras com resíduos de betão.

- O dente está embutido no corpo do disco para obter uma grande resistência.
- Os dentes podem ser novamente afiados para um maior aproveitamento do disco.
- Graças à sua estrutura reforçada conseguimos cortes retos sem desvios, sem necessidade de qualquer guia.

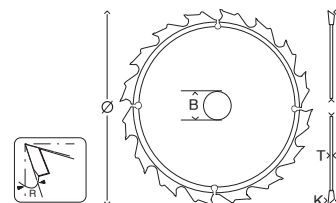

**Ø 190mm DHS710 - DHS782 - DHS783 - HS7601 - HS7100 - HS7101 - M5802B - HS004G**

Ø ext. (mm)	Ø int. (mm)	K (mm)	T (mm)	Nº dentes	R	Tipo de dente	Redução	Código	EAN	P.V.P (€)
190	30	2,6	1,6	12	20°	FTG Reforçado	-	B-33554	0088381422444	28,00

**Ø 210mm 5008MG**

210	30	2,8	1,8	14	20°	FTG Reforçado	-	B-33766	0088381422659	30,00
-----	----	-----	-----	----	-----	---------------	---	---------	---------------	-------

**Ø 235mm 5903R - 5903RK - DHS900 - HS009G**

235	30	2,8	1,8	16	20°	FTG Reforçado	-	B-13699	0088381359801	34,00
-----	----	-----	-----	----	-----	---------------	---	---------	---------------	-------





Discos de serra para serras circulares

Discos Specialized Painel Sandwich



Lâminas dentadas HM para corte de painel sanduíche específico.

Dente em forma triangular em oposição:

- Reduz a rebarba na peça de trabalho.
- Evita a rutura do disco.
- Ranhuras para evitar vibrações e ruídos.

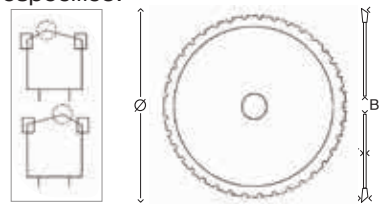

- Ideal para utilizar com os nossos modelos 5903R, 5104S, 5103R e 5143R.
- Longa duração. Muito bom acabamento, graças ao tipo de dente.



Ø 165mm DHS660 - DHS661 - DSS610 - DHS680 - HS6601 - HS6100										
Ø ext. (mm)	Ø int. (mm)	K (mm)	T (mm)	Nº dentes	R	Tipo de dente	Redução	Código	EAN	P.V.P (€)
165	20	1,75	1,4	42	0°	SMTCG LaserSlit	-	B-63149		63,00
Ø 235mm 5903R - 5903RK - DHS900 - HS009G										
235	30	2,2	1,8	50	0°	SMTCG LaserSlit	-	B-33582	0088381422475	93,00
Ø 270mm 5103R - HS0600										
270	30	2,4	2	60	0°	SMTCG LaserSlit	-	B-33598	0088381422482	134,00
Ø 355mm 5143R										
355	30	2,6	2,2	80	0°	SMTCG LaserSlit	-	B-33607	0088381422499	162,00

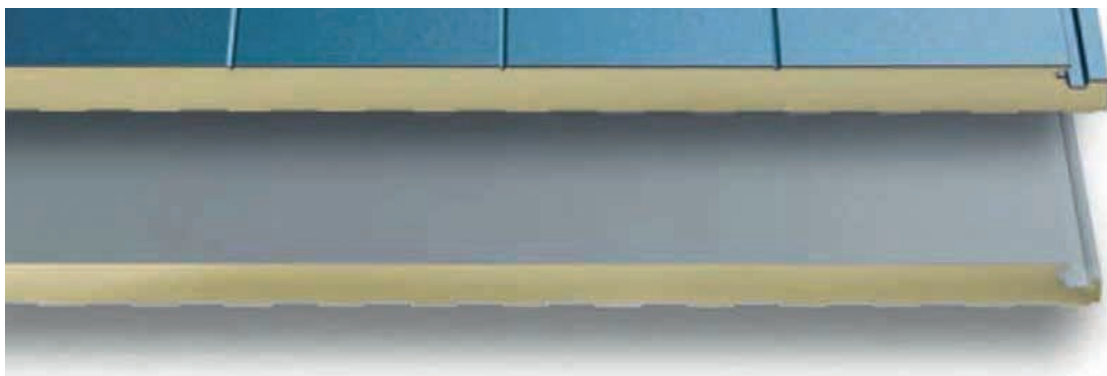

**Discos Specialized Bateria**



Os discos de qualidade superior são especialmente feitos para serras a bateria.

Lâminas de corte de madeira agora disponíveis para as mais populares serras circulares sem fio.

“Tudo com a qualidade Makita”.

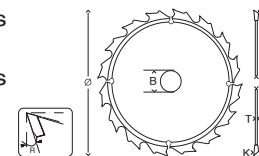

**Ø 85mm HS301D**

Ø ext. (mm)	Ø int. (mm)	K (mm)	T (mm)	Nº dentes	R	Tipo de dente	Redução	Código	EAN	P.V.P (€)
85	15	1,0	0,7	20	10°	ATB	Madeira	B-14607	0088381362689	10,20
85	15	0,5	0,5	50	-	-	Contraplacado	792299-8	0088381101004	14,30
85	15	0,5	0,5	50	-	-	Plástico	792259-0	0088381100816	11,00

**Ø 136mm DSS501**

136	20	1,5	1,0	16	20°	ATAF	Madeira	B-33532	-	26,00
-----	----	-----	-----	----	-----	------	---------	---------	---	-------

**Ø 165mm DHS660 - DHS661 - DSS610 - DHS680 - HS012G**

165	20	1,6	1	40	18°	ATAF	Madeira	B-32954	0088381421829	27,00
165	20	1,5	1	24	20°	ATAF	Madeira	B-32910	0088381421782	25,00
165	20	1,4	1	25	23	Efficut	Madeira	B-62985	-	31,00
165	20	1,45	1	56	23°	Efficut	Madeira	B-57336	0088381518420	50,00
165	20	1,5	1	24	15°	Efficut composite	Madeira	E-12217	0088381584753	30,00
165	20	1,5	1	40	15°	Efficut composite	Madeira	E-12223	0088381584760	43,00

**Ø 190mm DHS710 - DHS782 - DHS783 - HS004G**

190	30	2	1,4	24	20°	ATAF	Madeira	B-32926	0088381421799	22,00
190	30	2	1,4	40	10°	ATAF	Madeira	B-32976	0088381421843	26,00
190	20	1,85	1,35	50	8°	Efficut composite	Madeira	E-12251	0088381584784	61,00
<b>N</b> 190	30	1,5	1	24	23°	Corte limpo	-	B-64185	0088381533881	31,00

**Ø 216mm DHS900**

216	30	2	1,5	45	10°	Efficut	Madeira	E-06987	-	48,00
216	30	2	1,5	60	8°	Efficut composite	Madeira	E-12267	0088381584791	71,00

**Ø 235mm DHS900 - HS009G**

235	30	2,2	1,5	24	20	Efficut	Madeira	E-01909	0088381337236	44,00
-----	----	-----	-----	----	----	---------	---------	---------	---------------	-------

**Ø 260mm HS011G**

260	30	2,15	1,65	75	8	Efficut composite	Madeira	E-12273	0088381572040	80,00
-----	----	------	------	----	---	-------------------	---------	---------	---------------	-------



Makita

**Discos de serra para serras circulares**

**Discos Specialized Incisão**



Estes discos são específicos para serras de incisão.

Eles são projetados especificamente para conseguir um corte completamente limpo.

Os discos para serras de incisão têm uma tecnologia patenteada contra as vibrações.

Os discos de baixa vibração realizam o corte com menos vibração, para que o disco entre mais facilmente no material e com menos esforço.

- A estrutura do disco é de aço tensionado de precisão para maior rigidez e cortes mais retos.
- Adequado para cortar madeira.

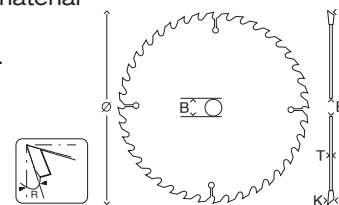

**Ø 165mm DSP600 - DSP601 - SP001G - SP6000**

Ø ext. (mm)	Ø int. (mm)	K (mm)	T (mm)	Nº dentes	R	Tipo de dente	Redução	Código	EAN	P.V.P (€)
160	20	2,2	1,6	28	23°	ATB Laser slit	-	B-32982	0088381421850	31,00
165	20	2	1,4	28	15°	ATB Laser slit	-	B-56758	-	47,00
160	20	2,2	1,6	48	8°	ATB Laser slit	-	B-32998	0088381421867	37,00
165	20	2,2	1,6	48	8°	ATB Laser slit	-	B-33015	-	57,00

**Especial MDF**

165	20	2	1,4	60	5°	-	-	B-56786	0088381495967	61,00
-----	----	---	-----	----	----	---	---	---------	---------------	-------

**Especial para Corian**

165	20	2,4	1,7	48	5°	TCG	-	B-10344	0088381342100	64,00
165	20	2,0	1,4	48	5°	TCG	-	B-56801	-	71,00

**Especial para Alumínio**

165	20	2,4	1,7	56	-3°	TCG LaserSlit	-	B-33021	0088381421898	61,00
165	20	2,0	1,4	56	-3°	TCG LaserSlit	-	B-56714	0088381534802	73,00



Discos de serras de esquadria

Discos MakBlade corte silencioso



Os discos de serra MAKBLADE PLUS para serras de esquadria têm uma tecnologia única e patenteada. Estes discos são desenvolvidos para atenuar as vibrações e ruídos. Estes discos característicos melhoram o ambiente de trabalho e aumentam a durabilidade da lâmina e a confiabilidade da máquina como um todo. A vida útil dos dentes é significativamente prolongada por se cuidar melhor dos seus discos de carboneto de tungstênio do que os discos convencionais.

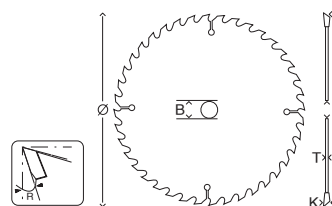

- Menos vibração e ruído.



Ø 190mm DLS600 - DLS714 - LS0714F											
Ø ext. (mm)	Ø int. (mm)	K (mm)	T (mm)	N° dentes	R	Tipo de dente	Redução	Código	EAN	P.V.P (€)	
190	20	2.0	1,4	60	5°	ATAF	-	B-32580	-	48,00	
Ø 250mm DLS111 - LF1000 - LH1040F - LS004G - LS1018L - LS1019L - LS1040F											
250	30	2,6	1,8	80	5°	TCG	-	B-42640	0088381440882	98,00	
250	30	2,6	1,8	80	5°	HI - ATB	-	B-42662	0088381440905	98,00	
Ø 260mm DLS111 - LF1000 - LH1040F - LS004G - LS1018L - LS1019L - LS1040F											
260	30	2,3	1,8	70	5°	ATAF	-	B-32530	0088381421348	66,00	
Ø 305mm DLS211 - LH1201FL - LS003G - LS1219L											
305	30	2,5	1,9	70	0°	ATAF	-	B-32568	0088381421379	78,00	

Discos MakBlade



Para uma vasta gama de aplicações, desde o corte grosseiro até ao corte com um acabamento extra fino.

- As serras de aço tensionado absorvem os choques sem deformar.
- Carboneto de tungstênio de alta qualidade e baixo desgaste para uma longa vida útil da serra.
- Corte fino com menos aparas e menos stress no motor.



Ø 190mm DLS600 - LS0714F - DLS714											
Ø ext. (mm)	Ø int. (mm)	K (mm)	T (mm)	N° dentes	R	Tipo de dente	Redução	Código	EAN	P.V.P (€)	
190	20	2,2	1,6	24	5°	ATB	-	B-32708	0088381421515	25,00	
190	20	2,2	1,6	48	5°	ATB	-	B-32758	-	35,00	
190	20	2.0	1,4	60	5°	ATB	-	B-09042	0088381337083	35,00	
Ø 216mm LS002G - LS0815FL											
216	30	2,1	1,6	40	10°	ATB	-	A-86169	0088381150026	48,00	
216	30	2,4	1,6	48	5°	ATB	-	B-32764	0088381421577	44,00	
216	30	2,2	1,6	80	5°	ATB	-	A-86468	0088381150804	74,00	
Ø 260mm DLS111 - LF1000 - LH1040F - LS004G - LS1018L - LS1019L - LS1040F											
255	30	2,3	1,8	32	5°	ATB	-	B-32720	0088381421539	56,00	
255	30	2,3	1,8	60	5°	ATB	-	B-32792	0088381421607	52,00	
260	30	2,3	1,8	40	5°	ATB	-	B-32770	0088381421584	40,00	
260	30	2,3	1,8	60	5°	ATB	-	B-32801	0088381421614	48,00	
260	30	2,3	1,8	80	5°	ATB	-	B-32845	0088381421652	51,00	
260	30	2,3	1,8	100	5°	ATB	-	B-32873	0088381421683	54,00	
260	30	2,5	1,65	80	10°	Efficut	-	B-67290	-	70,00	
Ø 305mm LH1201FL - LS1219L - DLS211											
305	30	2,3	1,8	40	5°	ATB	-	B-32786	0088381421591	51,00	
305	30	2,3	1,8	60	5°	ATB	-	B-32817	0088381421621	67,00	
305	30	2,3	1,8	80	5°	ATB	-	B-32851	0088381421669	80,00	
305	30	2,3	1,8	100	5°	ATB	-	B-32889	0088381421690	88,00	
305	30	2,15	1,65	60	10°	Efficut	-	B-67309	-	83,00	

**Discos de serras de esquadria**

**Discos Specialized Alumínio**



- Chapas metálicas esticadas de precisão para maior rigidez e cortes mais retos.
- Excelente qualidade de corte em materiais não ferrosos.
- Perfeito desempenho de corte em pisos laminados.

Aplique cera de disco na área do dente frequentemente para evitar a acumulação de aparas nos dentes ao cortar metais não ferrosos.

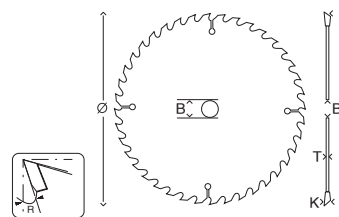

**Ø 190mm DLS600 - DLS714Z - LS0714F**

Ø ext. (mm)	Ø int. (mm)	K (mm)	T (mm)	Nº dentes	R	Tipo de dente	Redução	Código	EAN	P.V.P (€)
190	20	2	1,4	60	-5°	TCG	-	B-33283	0088381422154	44,00

**Ø 216mm LS0815FL - LS002G**

216	30	2,2	1,6	64	-5°	TCG	-	B-33875	-	102,00
-----	----	-----	-----	----	-----	-----	---	---------	---	--------

**Ø 260mm DLS111 - LF1000 - LH1040F - LS004G - LS1018L - LS1019L - LS1040F**

250	30	2,4	1,8	72	5	ATB	-	B-33308	0088381422185	48,00
250	30	2,4	1,8	100	-5°	TCG	-	B-33314	-	73,00
260	30	2,4	1,8	80	-5°	TCG	-	B-33320	0088381422208	67,00
260	30	2,4	1,8	100	-5°	TCG	-	B-33336	0088381422215	75,00
260	30	1,85	1,5	81	-3°	SMTCG	-	E-06317	-	87,00

**Ø 305mm DLS211 - LH1201FL - LS003G - LS1219L**

305	30	2,4	1,8	80	-5°	TCG	-	B-33342	0088381422222	71,00
305	30	2,4	1,8	100	-5°	TCG	-	B-33358	-	98,00
305	30	2	1,65	81	-3	Efficut	-	E-13253	0088381591270	123,00
305	30	2	1,65	96	-3	Efficut	-	E-13312	0088381591287	138,00



★★★★  
★★★★

**Discos Specialized Standard Economy**



Ø ext. (mm)	Ø int. (mm)	K (mm)	T (mm)	Nº dentes	R	Tipo de dente	Redução	Código	EAN	P.V.P (€)
<b>N</b> 255	30	2,6	1,8	40	15°	ATB	-	D-74049	0088381587082	18,70
305	30	2,8	2	60	15°	ATB	-	D-72316	0088381569040	35,00
305	30	2,8	2	80	15°	ATB	-	D-72322	0088381569057	40,00
305	30	2,8	2	100	15°	ATB	-	D-72338	0088381569064	45,00



**Discos Specialized Serras de mesa - Madeira**



- Concebidos para serras de mesa Makita e outros fabricantes de serras.

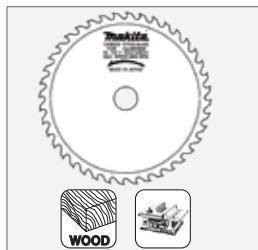
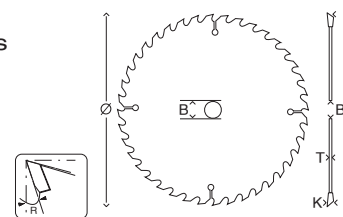

<b>Ø 260mm 2704 e MLT100</b>											
260	30	2,3	1,5	40	20°	TCG	-	B-05072	0088381200677	46,00	
<b>N</b> 260	30	2,6	1,8	40	15°	ATB	-	D-74077	0088381587112	19,30	
<b>Ø 315mm 2712</b>											
315	30	2,8	2,0	40	16°	Corte rápido	-	JM27170001	0088381531641	33,00	

**Discos Specialized Serras de mesa - Alumínio**



<b>Ø 260mm 2704 - MLT100</b>											
Ø ext. (mm)	Ø int. (mm)	K (mm)	T (mm)	Nº dentes	R	Tipo de dente	Redução	Código	EAN	P.V.P (€)	
260	30	2,8	2,2	80	0°	TCG	-	B-33386		76,00	
<b>Ø 300mm</b>											
300	30	2,8	2,2	80	0°	TCG	-	B-33392	0088381422277	82,00	

**Discos Specialized laminados**



- Excelente qualidade de corte em pisos laminados.
- Alta precisão de corte em molduras e rodapés.

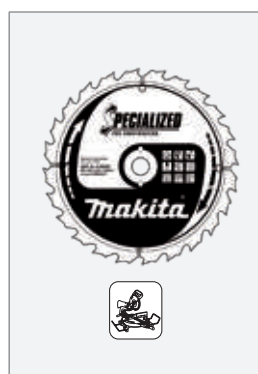
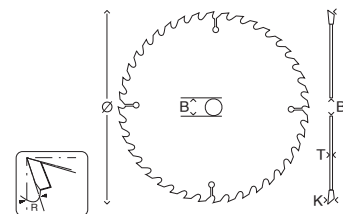

<b>Ø 216mm LS0815FL - LS002G</b>											
Ø ext. (mm)	Ø int. (mm)	K (mm)	T (mm)	Nº dentes	R	Tipo de dente	Redução	Código	EAN	P.V.P (€)	
216	30	2,5	1,8	72	5°	TCG	-	B-33853	0088381422703	110,00	
<b>Ø 260mm DLS111 - LF1000 - LH1040F - LS004G - LS1018L - LS1019L - LS1040F</b>											
260	30	2,5	1,8	84	5°	TCG	-	B-29496	0088381416641	102,00	
<b>Ø 305mm DLS211 - LH1201FL - LS003G - LS1219L</b>											
305	30	2,5	1,8	96	5°	TCG	-	B-33881	0088381422734	168,00	

**Disco PCD especial fibrocimento**



<b>Ø 165mm</b>											
Ø ext. (mm)	Ø int. (mm)	K (mm)	T (mm)	Nº dentes	R	Tipo de dente	Redução	Código	EAN	P.V.P (€)	
165	20	1,8	1,4	4	12°	PCD	-	D-72067	-	36,00	

**Discos Specialized Fresagem CA5000**

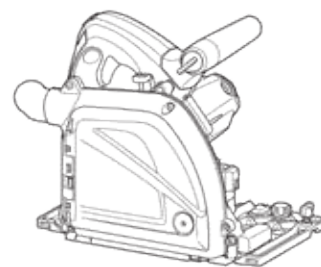

**Ø 118mm - CA5000**

Ø ext. (mm)	Ø int. (mm)	K (mm)	T (mm)	Nº dentes	R	Material	Redução	Código	EAN	P.V.P (€)
118	20	14	6	6	90°	Composito de aluminio	-	B-48832	0088381458733	178,00
118	20	18	6	6	135°	Composito de aluminio	-	B-48860	0088381458740	196,00

**Lâminas de corte DSC102 / SC103D**



Tipo	Código	EAN	P.V.P (€)
M6	199087-8	0088381524766	73,00
M8	199085-2	0088381524759	73,00
M10	199083-6	0088381524742	73,00

**Disco de corte CP100D**



Código	EAN	P.V.P (€)
198603-3	0088381487344	10,10

**Disco de corte DSC250**



**Ø 110mm - DSC250 - DSC251**

Ø ext. (mm)	Ø int. (mm)	K (mm)	T (mm)	Nº dentes	R	Tipo de dente	Redução	Código	EAN	P.V.P (€)
110	15	-	-	24	0°	SMTCG	-	E-11097	0088381581752	72,00



Makita

**Discos de serra para cortadoras de metal**

**Discos Specialized - Corte de metal**

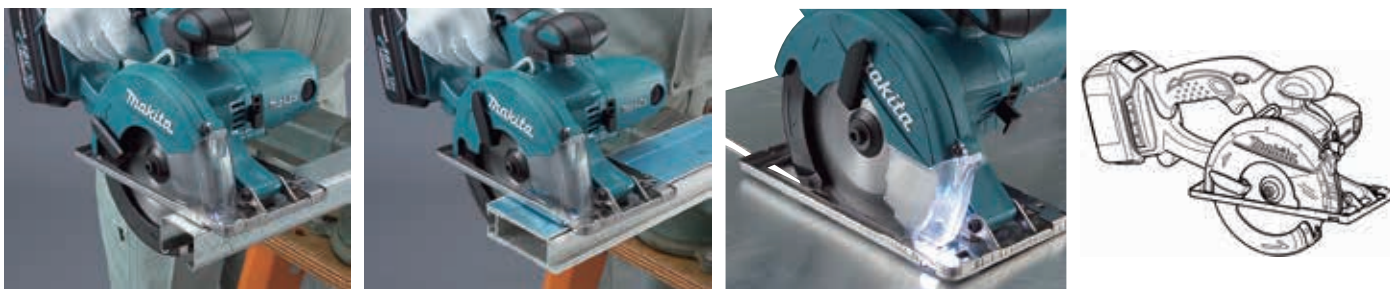

**Ø 136mm DCS550**

Ø ext. (mm)	Ø int. (mm)	K (mm)	T (mm)	Nº dentes	Tipo	Tipo de dente	Redução	Código	EAN	P.V.P (€)
136	20	1,5	1,2	30	-	SMTCG	Metal	B-33526	-	57,00
136	20	1,4	1,0	50	-	SMTCG	Chapa fina	B-07325	0088381312813	47,00
136	20	1,1	0,95	56	-	SMTCG	Inox	B-33744	-	73,00

**Ø 150mm DCS551 - DCS553**

150	20	1,5	1,2	32	-	SMTCG	Metal	B-47036	-	44,00
150	20	1,4	1,1	52	-	SMTCG	Chapa fina	B-47042	-	61,00
150	20	1,1	0,95	60	-	SMTCG	Inox	B-47058	-	66,00
150	20	1,6	1	52	-	SMTCG	Alumínio	B-47064	-	61,00

**Ø 185mm 4131**

Ø ext. (mm)	Ø int. (mm)	K (mm)	T (mm)	Nº dentes	Tipo	Tipo de dente	Redução	Código	EAN	P.V.P (€)
185	30	1,7	1,3	70	-	HM	Aço	B-33445	-	57,00
185	30	2	1,6	48	-	HM	Aço	B-33451	-	56,00
185	30	2	1,6	38	-	HM	Aço	B-33423	-	50,00
185	30	-	-	38	-	HM	Aço	E-14299	0088381593656	72,00
185	30	1,9	1,5	36	-	Cermet	Aço	B-33417	0088381422291	70,00



**Ø 305mm LC1230**









































305	25,4	2,1	1,7	60	-	HM	Aço	B-33439	-	123,00
305	25,4	2,3	2	78	-	HM	Aço macio	B-33467	-	149,00
305	25,4	1,95	1,95	76	-	HM	Inox	A-87579	0088381160445	254,00
305	25,4	2,4	1,5	100	Silencioso	HM	Inox	B-33750	-	303,00
<b>N</b> 305	25,4	2	1,75	63	-2°	Efficut	Aço	E-12055	-	303,00





**Discos de HM para LC1230**



















































	Ø (mm)	Nº de dentes	Código
	305	HM60	B-33439
		HM78	B-33467
		HM76	A-87579
		HM100	B-33750





Código	B-33439	B-33467	A-87579	B-33750
Ø (mm.)	305 x 25,4			
Nº dentes	HM60	HM78	HM76	HM100
Material	Aço	Aço macio fino	Inox	Inox
 3 mm.				
 4 - 6 mm.				
 7 mm. -				
 1,2 - 3 mm.				
 3 - 5 mm.				
 2 - 4 mm.				
 4 mm. -				
 Inox 1,2 - 3 mm.				



**Discos de HM para 4131**

	Ø (mm)	Nº de dentes	Código
	185	HM70	B-33445
		HM48	B-33451
		HM38	B-33423
		Cermet 36	B-33417

Código	B-09771	B-33451	B-33423	B-33417
Ø (mm.)	185x30x2	185x30x2	185x30x2	185x30x1,9
Nº dentes	HM70 (-10°)	HM48 (0°)	HM38 (0°)	*Cermet36 (0°)
Quadrado de ferro	50 x 50 x 4 mm.			
	50 x 50 x 4 mm.			
	50 x 50 x 6 mm.			
	50 x 100 x 3,2 mm.			
Aço em chapas	0,9 x 500 mm.			
	3,0 x 500 mm.			
Perfis em U	50 x 100 x 1,6 mm.			
	45 x 90 x 3,2 mm.			
Ângulo	50 x 50 x 4 mm.			
	50 x 50 x 6 mm.			
Tubos de aço temperado	Ø 25 x 1,2 mm.			
Tubos metálicos	Ø 60 x 4 mm.			
Haste	Ø 20 mm.			
Perfis de paredes divisorias secas	1 mm.			
	1 - 2 mm.			
Chapa ondulada (pégaso)	0,9 mm.			
	1 - 2 mm.			

-  Disco ideal.
-  Disco adequado.
-  Disco não recomendado.
-  Disco muito desaconselhado.

**Guias de carril e acessórios**



Peça para unir dois carris

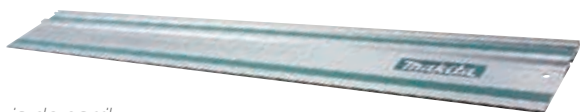

Guia de carril



Funda para carril guia

Descrição	Comp. (m)	Unds.	Código	EAN	P.V.P (€)
Peça para unir dois carris	-	1	198885-7	0088381497046	27,00
Guia de carril	1	1	199140-0	0088381528672	48,00
	1,4	1	194368-5	0088381313353	76,00
	1,9	1	194925-9	0088381354790	117,00
	3	1	194367-7	0088381335201	198,00
Capa para guia de carril	1	1	E-05670	0088381567183	49,00
	1,4	1	E-05664	0088381567176	57,00
	1,9	1	E-10920	0088381581523	89,00
	3	1	E-10936	0088381581530	110,00

**Suportes de guia de carril**

**A**



192505-5

**B**



192506-3 e 192507-1

**C**

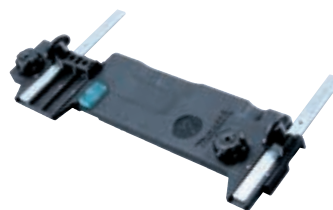

197252-3

**D**



199232-5



**Guia de ângulos**



Unds.	Código	EAN	P.V.P (€)
1	196664-7	0088381438414	42,00

Modelos	Imagem	Unds.	Código	EAN	P.V.P (€)
5603R 5705R	A	1	192505-5	0088381131919	31,00
5903R	B	1	192506-3	0088381132190	122,00
5103R	B	1	192507-1	0088381132206	91,00
HS6100 HS7100 HS7101 DHS710	C	1	197252-3	0088381453790	71,00
HS0600	C	1	198570-2	0088381495912	230,00
HS6601	C	1	197462-2	0088381523837	29,00
HS7601 HS7611	C	1	197005-0	0088381484602	70,00
DHS680	C	1	196953-0	0088381463751	56,00
DHS660	D	1	199232-5	0088381529334	56,00

**Peças sobressalentes para guias de carril**

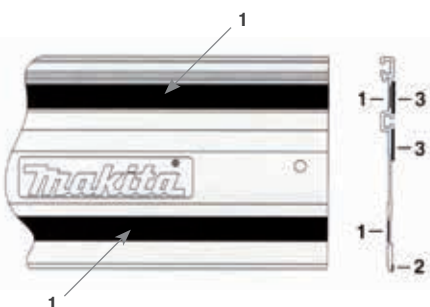

Descrição	Comprimento	Número	Unds.	Código	EAN	P.V.P (€)
Borracha deslizante	1,4	1	1	413101-9	3240890284549	4,40
	1,9		1	451330-6	-	6,60
	3,0		1	413102-7	3240890284488	16,50
Borracha anti-lascas	1,4	2	1	423359-2	3240890283870	6,00
	1,9		1	423386-9	-	8,80
	3,0		1	423360-7	3240890284136	11,80
Borracha antideslizante	1,4	3	1	423361-5	3240890282088	7,20
	1,9		1	423390-8	-	9,90
	3,0		1	423362-3	3240890281838	16,50

### Grampo para carril de guia



Modelos	Unds.	Código	EAN	P.V.P (€)
Guias de carril	2	194385-5	0088381314084	30,00

### Guia paralela



Modelos	Tipo	Unds.	Código	EAN	P.V.P (€)
HS301	1	1	195333-7	-	3,30
5604R 5704R HS6100 HS7100 HS7101 HS7601		1	164095-8	0088381101080	1,95
5017RKB 5603R 5703R 5705R		1	165108-8	0088381141376	6,90
5903R 5103R		1	165084-6	0088381152464	4,50
5143R		1	152498-8	0088381156295	50,00
DSP600 DSP601 SP6000	2	1	165447-6	0088381347587	17,00

### Placa-guia para CA5000

- Marca a linha de fresagem.



Modelos	Unds.	Código	EAN	P.V.P (€)
CA5000	1	143396-7	-	4,40

### Ganchos



Modelos	Unds.	Código	EAN	P.V.P (€)
DHS780	1	199386-8	0088381534963	16,70
DHS660	1	199231-7	0088381532839	9,50

### Mesa para serras de esquadria



194043-3



DEAWST05



DEAWST06  
DEAWST07

	Comprimento (mm)	Altura (mm)	Largura (mm)	Modelos	Unds.	Código	EAN	P.V.P (€)
	762	841	743	LS0714F LH1040F LS1019L LS1018L LS1040F LS1219L LH1201FL	1	198688-9	0088381488938	200,00
	2.700	500	800	Todos os modelos	1	DEAWST05	0088381424318	349,00
	2.550	750	850		1	DEBWST06	0088381567350	318,00
	3.830	860	750	Adequada para todos os modelos, exceto DLS600, LH1040/F e LH1201FL.	1	DEAWST07	0088381565301	435,00



**Mesas para serras de mesa**



194093-8

JM27000300

Modelos	Unds.	Código	EAN	P.V.P (€)
2704	1	194093-8	0088381205702	375,00
MLT100	1	JM27000300	0088381351003	320,00



**Extensão de suporte**



Modelos	Tipo	Unds.	Código	EAN	P.V.P (€)
LH1040 LS1040 LS0714F MLS100	Pé	1	122446-1	0088381156158	29,00
-	Barras	1	256812-1	0088381146517	26,00

**Batentes para cortes de molduras**



Modelos	Unds.	Código	EAN	P.V.P (€)
LS003G LS004G LS1019L LS1219L	2	192628-9	0088381141710	43,00
LS1016/L	2	192669-5	0088381146470	76,00

**Rolo auxiliar**



Comp. (mm)	Altura regulável (mm)	Unds.	Código	EAN	P.V.P (€)
250	47 - 140	1	A-47450	0088381289535	109,00

**Suportes laterais**

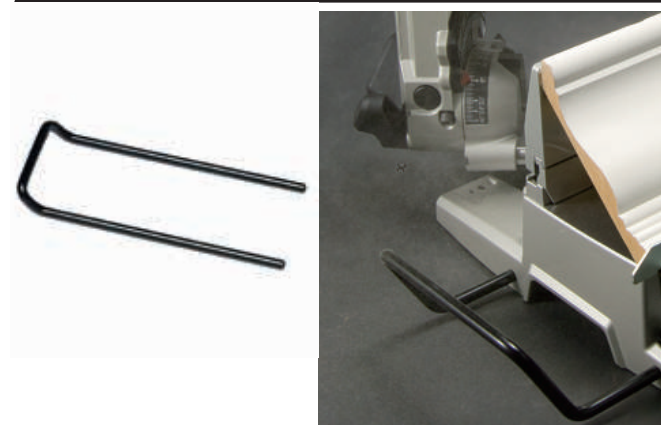

**Batente de apoio**



Modelos	Unds.	Código	EAN	P.V.P (€)
LS1013F/FLB LS1214F/L	1	194002-7	0088381193795	60,00

Modelos	Unds.	Código	EAN	P.V.P (€)
LS0810	1	164806-1	0088381162517	8,20
LS1013F/FLB LS1214F/L	1	322932-4	0088381141673	7,00
LH1040F LS1040F	1	123101-8	0088381538244	16,00
LS1440	2 + Batente ajustável	191239-7	0088381112093	30,00
MLS100	1	JM23000127	0088381347907	9,90
LS1016/L LS1216/FLB	2	195240-4	0088381366250	9,60
LH1200FL	1	JM23100500	0088381373623	11,40
LS1019L LS1219L	1	327095-1	0088381536189	5,90



### Grampos para serras de esquadria

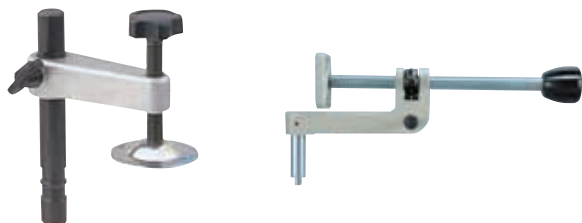

Vertical

Horizontal

Modelos	Tipo	Unds.	Código	EAN	P.V.P (€)
LS0714F BLS713RFE	Vertical	1	122571-8	0088381151863	23,00
LS0815		1	JM23510009	0088381447331	11,00
LS1013 LS1214		1	122538-6	0088381141697	20,00
LH1040F LS1040F		1	192625-5	0088381150729	20,00
LS1016/L LS1216/FL		1	122854-6	0088381356619	27,00
LF1000		1	122728-1	0088381288484	17,70
LS1018 LH1200FL		1	JM23100502	0088381373661	6,50
LS1019L LS1219L		1	126617-2	-	30,00
MLS100		1	JM23000131	0088381347938	8,20
LS0714F LS1040 LH1040		Horizontal	1	122567-9	0088381151573
LS1013 LS1214 LS1016/L LS1019L LS1219L	1		122470-4	0088381142625	91,00
LS1216/FLB LH1200FL LS1018L	1		122930-6	0088381366274	95,00

### Guias paralelas



Modelos	Unds.	Código	EAN	P.V.P (€)
2704	1	122739-6	0088381277020	124,00
LH1040F	1	122707-9	0088381195386	17,20
LF1000	1	122729-9	0088381288460	29,00
LH1201FL	1	JM23300008	3240890401823	56,00
2712	1	JM27110005	3240890419248	40,00

### Botão de segurança



Modelos	Unds.	Código	EAN	P.V.P (€)
Todos os modelos	1	417113-4	-	0,65

### Arnês para DLS600



Modelos	Unds.	Código	EAN	P.V.P (€)
DLS600	1	166058-0	0088381494953	11,60

### Guias de meia-esquadria



Modelos	Unds.	Código	EAN	P.V.P (€)
2704N	1	127069-0	-	49,00
LF1000	1	122730-4	0088381288477	16,50

### Extensões para 2704

Extensão traseira

Extensão esquerda



Descrição	Unds.	Código	EAN	P.V.P (€)
Extensão traseira	1	194087-3	0088381200301	44,00
Extensão esquerda	1	194086-5	0088381200295	36,00

### Batentes ajustáveis



Modelos	Unds.	Código	EAN	P.V.P (€)
LH1040 LS0714 LS1040	1	122472-0	0088381155892	5,50
MLS100	1	JM23000128	0088381347914	0,80



**Saco e caixa de pó**



122852-0



194175-6

**Anilha de redução**



Ø Interior (mm)	Ø Exterior (mm)	Unds.	Código	EAN	P.V.P (€)
15,88	25	1	257022-3	0088381189293	0,85
15,88	25,4	1	257060-5	0088381189309	1,40
15,88	30	1	257262-3	-	0,85

**Haste de impulso**



Unds.	Código	EAN	P.V.P (€)
1	416772-1	0088381149426	6,00

**Lâmpada**



Modelos	Unds.	Código	EAN	P.V.P (€)
LS0714F LS1013F LS1214F LS1040F	1	193730-1	0088381160353	4,10



Descrição	Modelo	Unds.	Código	EAN	P.V.P (€)
Saco	LS1018 LH1201FL	1	JM23100501	0088381373654	3,70
Saco	LS0810	1	122351-2	0088381115537	8,50
Saco	LS0815		JM23510010	0088381447348	7,20
Saco	LS1440	1	122330-0	0088381115544	16,00
Saco	LH1040 LS1214 LS1040 LS1016/L LS11019L LS1219L LS1216/FLB	1	122852-0	0088381356602	3,80
Saco	DLS600	1	122884-7	-	6,40
Caixa	Modelos FLB	1	194175-6	0088381349994	40,00



# Serras de sabre

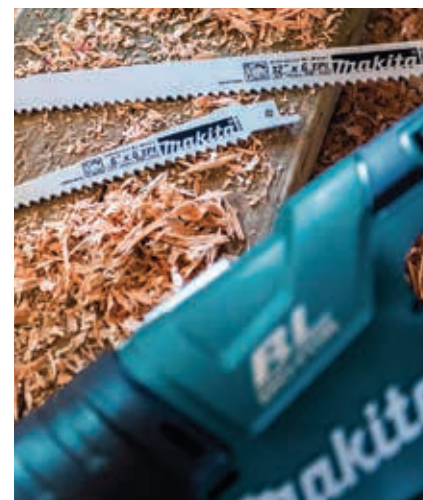

# Serras de sabre

**XGT** **40V** Li-ION **max**



## Mecanismo orbital

Maior velocidade de corte

Sistema de corte orbital

Para cortes em madeira e betão leve.

Sistema de corte reto

Para cortar tubos de ferro, alumínio, aço inoxidável ou plásticos diversos.

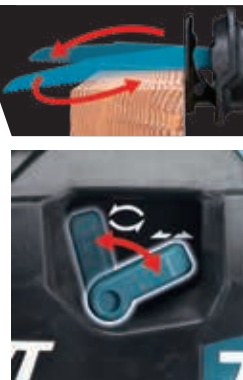

## Luz LED duplo

Com funções de luminescência e pré-luminescência



## Gancho

Marcador de velocidade variável

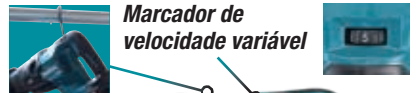

## Sistema anti-queda

Evita as quedas quando a posição da serra é ajustada. Além disso, facilita a substituição da lâmina sem ferramentas, acionando a alavanca e pressionando o botão.



Mecanismo de lubrificação do eixo redesenhado

Eixo

Contrapeso

**BL**  
**MOTOR**

Motor de alta potência sem escovas



**AVT**  
TECNOLOGIA ANTI-VIBRAÇÃO

Tecnologia anti-vibração. A vibração da ferramenta é reduzida ao mínimo graças a um mecanismo de contrapeso.



**Símbolos**



**Tipo de dentado**

**Tipo A**

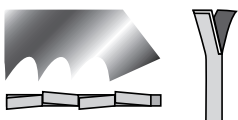

- Dentado: afiação alinhada, cortes rápidos em madeiras duras e macias, alumínio, plásticos e metais não ferrosos.

**Tipo B**

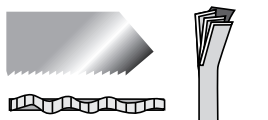

- Dentado: afiação ondulada, corte fino e limpo em madeira, aço macio, alumínio e metais não ferrosos.

**Tipo C**

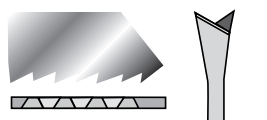

- Dentado: afiação trapezoidal, cortes finos e limpos em madeira e plásticos.

**Tipo C**

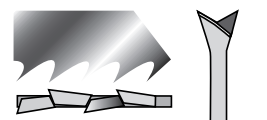

- Dentado: afiação alinhada trapezoidal, cortes grosseiros e rápidos em madeira.

**Serras de sabre**

**Metal**



Características	Tipo	Tipo de dentes	Dentes / polegada	Comp. (mm)	Largura (mm)	Unds.	Código	EAN	P.V.P. (€)
Para corte de aço, aço inoxidável e metais não ferrosos entre 3,5 mm e 5 mm. (A cor da lâmina pode variar - azul ou branca).	BiM	B	10 / 14	305	0,9	5	B-16857	0088381367554	22,00
				225			P-47008	0088381977432	21,00
				152			P-46997	0088381977425	16,10



Características	Tipo	Tipo de dentes	Dentes / polegada	Comp. (mm)	Largura (mm)	Unds.	Código	EAN	P.V.P. (€)
Para cortar metal de 4 mm a 12 mm. Corte rápido.	BiM	B	8 / 10	305	0,9	5	B-43212	0088381443081	26,00
				225			B-43181	0088381443050	22,00
				152			B-43147	0088381443012	18,50



Características	Tipo	Tipo de dentes	Dentes / polegada	Comp. (mm)	Largura (mm)	Unds.	Código	EAN	P.V.P. (€)
Dente em M para o corte rápido de aço, aço inoxidável e metais não ferrosos. Cortes em ambos os sentidos para aumentar a velocidade de corte.	BiM	M	M	260	0,9	5	P-45727	0088381976169	27,00
				200			P-45711	0088381976152	22,00
				150			P-45705	0088381976145	18,30



Características	Tipo	Tipo de dentes	Dentes / polegada	Comp. (mm)	Largura (mm)	Unds.	Código	EAN	P.V.P. (€)
Chapa grossa 4-12 mm, tubo <100 mm.	TC	-	8	152	1,25	1	B-55572	0088381483575	18,70
Chapa grossa 4-12 mm, tubo <175 mm.	TC	-	8	228	1,25	1	B-55588	0088381483582	22,00
Chapa grossa 4-12 mm, tubo <250 mm.	TC	-	8	305	1,25	1	B-55594	0088381483599	29,00

**Metal**



Características	Tipo	Tipo de dentes	Dentes / polegada	Comp. (mm)	Largura (mm)	Unds.	Código	EAN	P.V.P. (€)
Para cortar chapas com menos de 1,2 mm.	BiM	B	32	150	0,9	5	P-04955	0088381914109	16,60



Características	Tipo	Tipo de dentes	Dentes / polegada	Comp. (mm)	Largura (mm)	Unds.	Código	EAN	P.V.P. (€)
Para cortar chapas com mais de 1,2 mm. (A cor da lâmina pode variar - azul ou branca).	BiM	B	24	225	0,9	5	B-43169	0088381443036	18,70
				152			B-16835	0088381367530	12,70
				100			P-04896	0088381914048	14,90



Características	Tipo	Tipo de dentes	Dentes / polegada	Comp. (mm)	Largura (mm)	Unds.	Código	EAN	P.V.P. (€)
Para o corte de aço e aço inoxidável entre 1,5 mm e 2,5 mm. (A cor da lâmina pode variar - azul ou branca).	BiM	B	12	225	0,9	5	B-16776	0088381367479	17,70
				152			B-05169	0088381204224	13,80
				100			P-04874	0088381914024	14,90



Características	Tipo	Tipo de dentes	Dentes / polegada	Comp. (mm)	Largura (mm)	Unds.	Código	EAN	P.V.P. (€)
Para cortar metal de 3 mm a 8 mm.	BiM	B	14 / 18	305	1,1	5	B-43206	0088381443074	26,00
				225			B-43175	0088381443043	22,00
				152			B-43131	0088381443005	17,70



Características	Tipo	Tipo de dentes	Dentes / polegada	Comp. (mm)	Largura (mm)	Unds.	Código	EAN	P.V.P. (€)
Para corte de aço e aço inoxidável entre 1,5 mm e 2,5 mm.	BiM	B	18	225	0,9	5	B-16782	0088381367486	17,70
				152			B-16841	0088381367547	12,70



Características	Tipo	Tipo de dentes	Dentes / polegada	Comp. (mm)	Largura (mm)	Unds.	Código	EAN	P.V.P. (€)
Para cortar metal de 2 mm a 10 mm. Corte fino.	BiM	B	10 / 14	305	1,25	5	B-43228	0088381443098	26,00
				225			B-43197	0088381443067	22,00
				152			B-43153	0088381443029	17,70



**Madeira**



Características	Tipo	Tipo de dentes	Dentes / polegada	Comp. (mm)	Largura (mm)	Unds.	Código	EAN	P.V.P. (€)
Para todos os tipos de madeira com um acabamento fino.	HCS / CV	A	10	152	1,05	5	B-16807	0088381367509	9,60



Características	Tipo	Tipo de dentes	Dentes / polegada	Comp. (mm)	Largura (mm)	Unds.	Código	EAN	P.V.P. (€)
Lâmina grossa para cortes rápidos em madeira, plásticos e placas de gesso cartonado.	HCS / CV	A	6	305	1,25	5	B-16829	0088381367523	16,00



Características	Tipo	Tipo de dentes	Dentes / polegada	Comp. (mm)	Largura (mm)	Unds.	Código	EAN	P.V.P. (€)
Lâmina grossa para cortes rápidos em madeira, plásticos e placas de gesso cartonado.	HCS / CV	A	6	225	1,27	5	P-47092	0088381977524	14,90



Características	Tipo	Tipo de dentes	Dentes / polegada	Comp. (mm)	Largura (mm)	Unds.	Código	EAN	P.V.P. (€)
Lâmina grossa para cortes rápidos em madeira, plásticos e placas de gesso cartonado.	HCS / CV	C	6	150	1,27	5	P-47086	0088381977517	13,70



Características	Tipo	Tipo de dentes	Dentes / polegada	Comp. (mm)	Largura (mm)	Unds.	Código	EAN	P.V.P. (€)
Lâmina grossa para cortes rápidos em madeira, plásticos e placas de gesso cartonado.	BIM	A	6	150	1,27	5	P-05088	0088381914314	22,00



Características	Tipo	Tipo de dentes	Dentes / polegada	Comp. (mm)	Largura (mm)	Unds.	Código	EAN	P.V.P. (€)
Lâmina especial para madeira verde.	HCS/CV	C	5	305	1,5	5	B-16863	0088381367561	20,00



Características	Tipo	Tipo de dentes	Dentes / polegada	Comp. (mm)	Largura (mm)	Unds.	Código	EAN	P.V.P. (€)
Lâmina especial para madeira verde.	HCS/CV	C	4 - 5	240	1,27	5	P-47117	0088381977548	16,60



Características	Tipo	Tipo de dentes	Dentes / polegada	Comp. (mm)	Largura (mm)	Unds.	Código	EAN	P.V.P. (€)
Para cortes curvos em madeira e plástico.	HCS/CV	C	6	152	1,27	5	B-16798	0088381367493	9,60



**Madeira**



Características	Tipo	Tipo de dentes	Dentes / polegada	Comp. (mm)	Largura (mm)	Unds.	Código	EAN	P.V.P. (€)
Para cortes curvos e limpos em madeira, plástico e acrílico.	HCS / CV	D	6	150	1,8	5	P-47101	0088381977531	21,00



Características	Tipo	Tipo de dentes	Dentes / polegada	Comp. (mm)	Largura (mm)	Unds.	Código	EAN	P.V.P. (€)
Lâmina grossa para cortes rápidos em madeira, plásticos e placas de gesso cartonado.	HCS / CV	A	3	152	1,25	5	B-16813	0088381367516	9,60



Características	Tipo	Tipo de dentes	Dentes / polegada	Comp. (mm)	Largura (mm)	Unds.	Código	EAN	P.V.P. (€)
Dentado muito grosso para cortes rápidos e agressivos em madeiras húmidas.	HCS / CV	C	3	240	1,27	5	P-47123	0088381977555	17,80



Características	Tipo	Tipo de dentes	Dentes / polegada	Comp. (mm)	Largura (mm)	Unds.	Código	EAN	P.V.P. (€)
Dentado muito grosso para cortes rápidos e agressivos em madeiras húmidas.	HCS / CV	D	8,5	250	1,0	1	B-62016	0088381528719	16,50

**S-EXPRESS**



Características	Tipo	Tipo de dentes	Dentes / polegada	Comp. (mm)	Largura (mm)	Unds.	Código	EAN	P.V.P. (€)
Lâmina superexpresso com alto desempenho em serras sabre a bateria: Metal.	BiM	-	7 - 18	152	-	5	B-05038	0088381200592	17,70

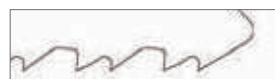

Características	Tipo	Tipo de dentes	Dentes / polegada	Comp. (mm)	Largura (mm)	Unds.	Código	EAN	P.V.P. (€)
Lâmina superexpresso com alto desempenho em serras sabre a bateria: Universal.	BiM	-	6 - 11	152	-	5	B-05044	0088381200608	15,40



Características	Tipo	Tipo de dentes	Dentes / polegada	Comp. (mm)	Largura (mm)	Unds.	Código	EAN	P.V.P. (€)
Lâmina superexpresso com alto desempenho em serras sabre a bateria: Madeira.	BiM	-	6 - 10	203	-	5	B-05153	0088381200943	16,00

**Madeira + Metal**



Características	Tipo	Tipo de dentes	Dentes / polegada	Comp. (mm)	Largura (mm)	Unds.	Código	EAN	P.V.P. (€)
Especial para Paletes	BiM	B	10	180	0,9	200	B-54265	0088381477307	412,00

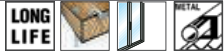

Características	Tipo	Tipo de dentes	Dentes / polegada	Comp. (mm)	Largura (mm)	Unds.	Código	EAN	P.V.P. (€)
Especialmente concebido para a reparação de paletes. Para cortar madeira com resíduos metálicos. Lâmina grossa.	BiM	A	8/10	150	1,27	5	P-47064	0088381977494	20,00



Características	Tipo	Tipo de dentes	Dentes / polegada	Comp. (mm)	Largura (mm)	Unds.	Código	EAN	P.V.P. (€)
Madeira com pregos, pvc, demolição.	BiM	-	5/8	305	1,6	5	B-43278	0088381443142	32,00
	BiM	-	5/8	225	1,6	5	B-43256	0088381443128	28,00
	BiM	-	5/8	152	1,6	5	B-43234	0088381443104	22,00



Características	Tipo	Tipo de dentes	Dentes / polegada	Comp. (mm)	Largura (mm)	Unds.	Código	EAN	P.V.P. (€)
Dente em M para o corte rápido de madeira e madeira com pregos. Cortes em ambos os sentidos para aumentar a velocidade de corte.	BiM	A	6	152	1,25	5	B-05175	0088381204231	16,00



Características	Tipo	Tipo de dentes	Dentes / polegada	Comp. (mm)	Largura (mm)	Unds.	Código	EAN	P.V.P. (€)
Dente em M para o corte rápido de madeira e madeira com pregos. Cortes em ambos os sentidos para aumentar a velocidade de corte.	BiM	M	-	200	0,9	5	P-45696	0088381976138	22,00
	BiM	M	-	150	0,9	5	P-45680	0088381976121	18,30



**Madeira + Metal**

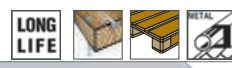

Características	Tipo	Tipo de dentes	Dentes / polegada	Comp. (mm)	Largura (mm)	Unds.	Código	EAN	P.V.P. (€)
Especialmente concebido para a reparação de paletes. Para cortar madeira com resíduos metálicos. Lâmina grossa.	BiM	A	10 / 14	225	1,27	5	P-47195	0088381977623	21,00
	BiM	A	10 / 14	150	1,27	5	P-47189	0088381977616	16,10

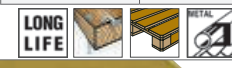

Características	Tipo	Tipo de dentes	Dentes / polegada	Comp. (mm)	Largura (mm)	Unds.	Código	EAN	P.V.P. (€)
Especialmente concebido para a reparação de paletes. Para cortar madeira com resíduos metálicos. Lâmina fina.	BiM	A	10 / 14	280	0,9	5	P-67767	0088381998291	26,00
	BiM	A	10 / 14	152	0,9	5	P-47014	0088381977449	15,40

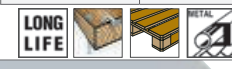

Características	Tipo	Tipo de dentes	Dentes / polegada	Comp. (mm)	Largura (mm)	Unds.	Código	EAN	P.V.P. (€)
Especial para paletes. Madeira com pregos, PVC e alumínio.	BiM	B	10 / 14	225	0,9	5	B-43262	0088381443135	18,70
	BiM	B	10 / 14	152	0,9	5	B-43240	0088381443111	13,80

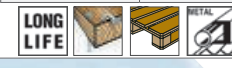

Características	Tipo	Tipo de dentes	Dentes / polegada	Comp. (mm)	Largura (mm)	Unds.	Código	EAN	P.V.P. (€)
Especialmente para paletes, madeira com pregos, alumínio.	BiM	B	10	225	0,9	5	B-31859	0088381420129	18,70
	BiM	B	10	152	0,9	5	B-31843	0088381420112	13,80



**ESPECIAIS**

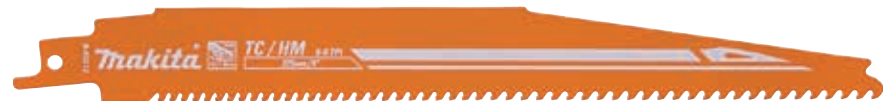

Características	Tipo	Tipo de dentes	Dentes / polegada	Comp. (mm)	Largura (mm)	Unds.	Código	EAN	P.V.P. (€)
Serra sabre de resgate 152 x 1,25 mm 6-8 TPI. Recomendada para situações de resgate.	TC / HM	-	6 - 8	152	1,25	25	B-67206	0088381540759	290,00
Serra sabre de resgate 225/1,25x6-8 TPI	TC / HM	-	6 - 8	225	1,25	25	B-67212	0088381540766	495,00

**ESPECIAIS**

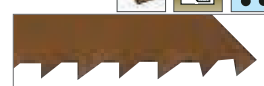

Características	Tipo	Tipo de dentes	Dentes / polegada	Comp. (mm)	Largura (mm)	Unds.	Código	EAN	P.V.P. (€)
Ideal para madeiras duras, betão esponjoso, eternit, plásticos reforçados com fibra de vidro e epóxi. Dentes de carboneto de tungsténio.	HM	A	3	400	1,3	1	P-05066	0088381914215	49,00
	HM	A	6	300	1,3	-	P-05050	0088381914208	55,00
				150			P-05044	0088381914192	26,00
				100			P-05038	0088381914185	22,00



Características	Tipo	Tipo de dentes	Dentes / polegada	Comp. (mm)	Largura (mm)	Unds.	Código	EAN	P.V.P. (€)
Especial para tijolos.	HM	-	2	400	-	1	B-10403	0088381342667	50,00
				265			B-10394	0088381342650	36,00

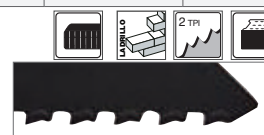

Características	Tipo	Tipo de dentes	Dentes / polegada	Comp. (mm)	Largura (mm)	Unds.	Código	EAN	P.V.P. (€)
Especial para tijolos ocus.	HM - TC	-	2	240	-	1	B-12809	0088381355544	28,00



Características	Tipo	Tipo de dentes	Dentes / polegada	Comp. (mm)	Largura (mm)	Unds.	Código	EAN	P.V.P. (€)
Para corte em cerâmica, ferro fundido, tijolo muito duro e plásticos reforçados com fibra de vidro e epóxi.	CV-HM	-	-	180	1,05	2	P-47173	0088381977609	17,20



Características	Tipo	Tipo de dentes	Dentes / polegada	Comp. (mm)	Largura (mm)	Unds.	Código	EAN	P.V.P. (€)
Especialmente para produtos congelados. Lâmina de aço inoxidável não pintada.	INOX	-	6	152	-	1	B-52043	0088381467544	24,00
		A		305			B-10609	0088381346641	10,20
		-		228			B-30564	0088381418607	24,00



Características	Tipo	Tipo de dentes	Dentes / polegada	Comp. (mm)	Largura (mm)	Unds.	Código	EAN	P.V.P. (€)
Especialmente concebido para o corte de aço inoxidável.	HN	-	18	152	-	2	B-07250	0088381310734	32,00



Características	Tipo	Tipo de dentes	Dentes / polegada	Comp. (mm)	Largura (mm)	Unds.	Código	EAN	P.V.P. (€)
Fibrocimento/Tijolo 10-250 mm Epóxi 6-150 mm	TC / HM	-	3	305	1,5	2	B-63585	0088381532846	43,00



Características	Tipo	Tipo de dentes	Dentes / polegada	Comp. (mm)	Largura (mm)	Unds.	Código	EAN	P.V.P. (€)
Fibrocimento/Tijolo 20-350 mm Epóxi 6-150 mm	TC / HM	-	2	400	1,5	2	B-63591	0088381532853	51,00



Para serra de sabre JR100D - DJR183



Características	Tipo	Tipo de dentes	Dentes / polegada	Comp. (mm)	Largura (mm)	Unds.	Código	EAN	P.V.P. (€)
Metal	BIM	-	24	100	0,7 - 3,0	5	B-20395	0088381375986	12,10



Características	Tipo	Tipo de dentes	Dentes / polegada	Comp. (mm)	Largura (mm)	Unds.	Código	EAN	P.V.P. (€)
Metal	BIM	-	18	100	1,5 - 4,0	5	B-20404	0088381375993	12,10



Características	Tipo	Tipo de dentes	Dentes / polegada	Comp. (mm)	Largura (mm)	Unds.	Código	EAN	P.V.P. (€)
Metal	BIM	-	14	100	3,0 - 8,0	5	B-20410	0088381376006	12,10



Características	Tipo	Tipo de dentes	Dentes por polegada	Comp. total (mm)	Largura (mm)	Unds.	Código	EAN	P.V.P. (€)
Madeira - metal	BIM	-	10	100	Metal 3,0 - 12 / Madeira 10 - 50	5	B-20426	0088381376013	12,10



Características	Tipo	Tipo de dentes	Dentes / polegada	Comp. (mm)	Largura (mm)	Unds.	Código	EAN	P.V.P. (€)
Madeira com pregos	BIM	-	6	100	10 - 50	5	B-20432	0088381376020	12,10



Características	Tipo	Tipo de dentes	Dentes / polegada	Comp. (mm)	Largura (mm)	Unds.	Código	EAN	P.V.P. (€)
Painéis de fibra	BIM	-	6	100	5,0 - 50	5	B-20448	0088381376037	12,10



Características	Tipo	Tipo de dentes	Dentes / polegada	Comp. (mm)	Largura (mm)	Unds.	Código	EAN	P.V.P. (€)
Madeira - metal	BIM	-	14 / 18	100	Metal 3,0 - 8,0 / Madeira 10 - 50	5	B-20454	0088381376044	12,10





Lâminas para 2107FK / 2107FXK (13 mm. x 0,5 mm. x 1.140 mm.)

Corte de METAL



Dentes por polegada	Capacidade máxima	Espessura (mm)	Material	Unds.	Código	EAN	P.V.P. (€)
14 HCS	+ de 5 mm	0,5 mm	Aço de carbono	3	792560-3	0088381117517	40,00
18 HCS	4 - 5 mm	0,5 mm		3	792559-8	0088381117524	40,00
24 HCS	- de 4 mm	0,5 mm		3	792558-0	0088381117531	40,00
14 HSS	+ de 5 mm	0,5 mm	Bi-Metal	1	194691-8	0088381350808	22,00
18 HSS	4 - 5 mm	0,5 mm		1	792556-4	0088381117555	25,00
24 HSS	- de 4 mm	0,5 mm		1	194692-6	0088381350815	22,00
10 HSS	+ de 5,5 mm	0,5 mm		1	B-30128	0088381417846	19,00

Corte de MADEIRA

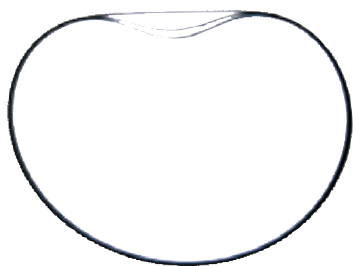

Madeira		Velocidade		Espessura (mm)	Material	Dentes por polegada	Unds.	Código	EAN	P.V.P. (€)
Com pregos	Sem pregos	Alta	Baixa							
1	1	1	-	0,5	Aço de carbono	6	3	792567-9	0088381117579	40,00

Serras de fita para LB1200F (2.240mm)

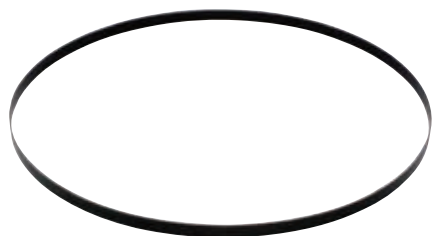

Aplicação	Material	Espessura (mm)	Dentes por polegada	Largura da lâmina (mm)	Unds.	Código	EAN	P.V.P. (€)
Madeira corte transversal	Aço de carbono	0,5	4	16	3	B-16667	0088381366731	60,00
Madeira corte universal		0,5	4	13	3	B-16673	0088381366748	50,00
Madeira corte curvo		0,5	6	6	3	B-16689	0088381366755	49,00
Metais não ferrosos		0,5	14	16	3	B-16695	0088381366762	66,00



**Serras de fita para DPB181 - DPB182 - DPB183 (835mm)**

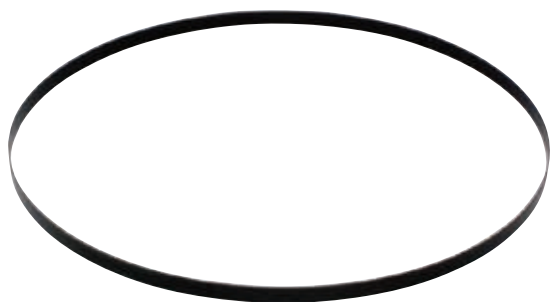

Aplicación	Material	Espessura	Dentes por polegada	Largura da lâmina (mm)	Unds.	Código	EAN	P.V.P. (€)
Plásticos, metais não ferrosos, ferro, aço inoxidável	Bi-Metal	0,5	14	13	5	B-40543	0088381438377	51,00
		0,5	18	13	5	B-40559	0088381438384	51,00
		0,5	24	13	5	B-40565	0088381438391	50,00

**Serras para DSD180 - SD100D**



Aplicação	Unds.	Código	EAN	P.V.P. (€)
Paredes divisórias secas*	2	B-49703	0088381460934	22,00
Madeira	2	B-49719	0088381460941	29,00

\*Perfeita para realizar recortes em paredes divisórias secas.



Makita



**Suporte de lixas LB1200F**

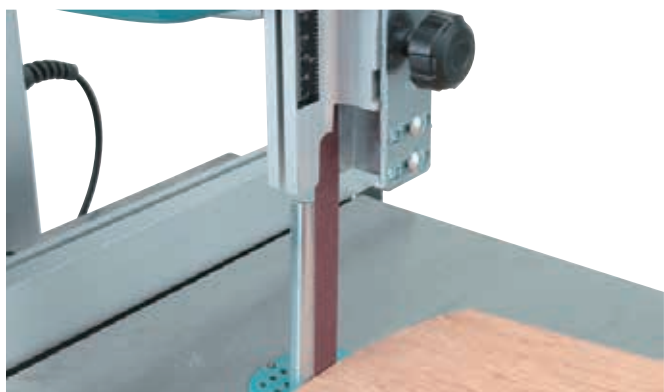

Unds.	Código	EAN	P.V.P. (€)
1	JM21000330	0088381374170	16,00

**Guia paralela para LB1200F**



Unds.	Código	EAN	P.V.P. (€)
1	JM21080230	3240890352613	21,00

**Guia angular**



Unds.	Código	EAN	P.V.P. (€)
1	JM21080260	3240890352620	11,60

**Extensão de mesa para LB1200F**



Unds.	Código	EAN	P.V.P. (€)
1	JM21000300	0088381374156	89,00

**Set para corte circular para LB1200F**

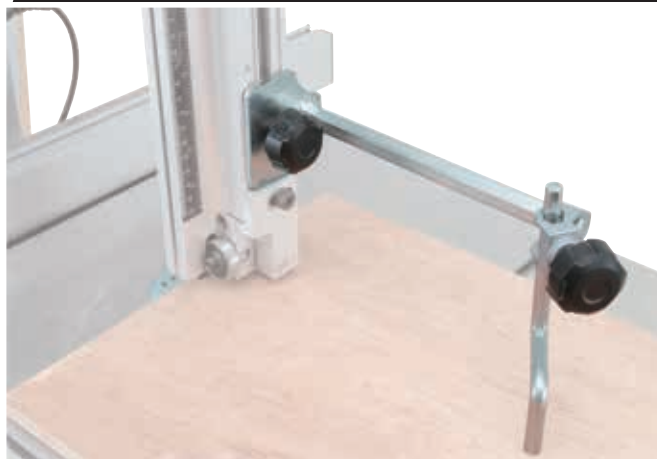

Unds.	Código	EAN	P.V.P. (€)
1	JM21000320	0088381374163	25,00

**Conexão de aspiração**



Unds.	Código	EAN	P.V.P. (€)
1	JM27000090	3240890357519	0,80



**Suporte e protetor para 2107FK**

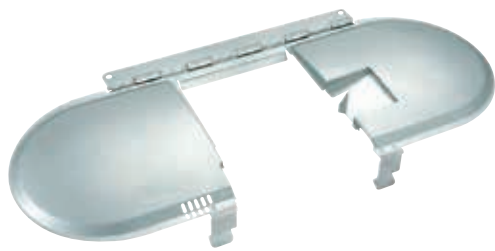

Protetor

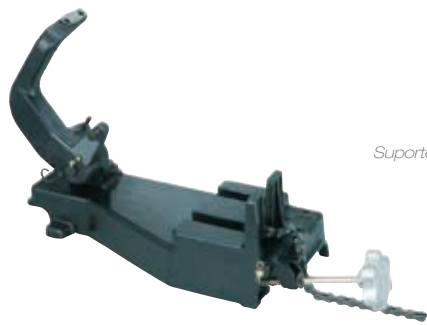

Suporte



Descrição	Unds.	Código	EAN	P.V.P. (€)
Protetor	1	196325-9	0088381431576	116,00
Suporte	1	194026-3	0088381194662	685,00



**Batente de profundidade**

**Pasta lubrificante**



Fixo

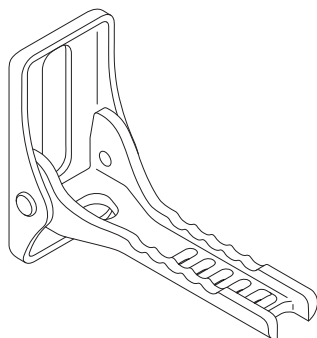

Móvel



Modelo	Tipo	Unds.	Código	EAN	P.V.P. (€)
JR3050T JR3060T	Fixo (equipamento básico)	1	165396-7	-	6,10
JR3070CT	Fixo (equipamento básico)	1	165406-0	-	5,40
JR3070CT	Móvel (opcional)	1	163453-5	-	7,60



Unds.	Código	EAN	P.V.P. (€)
1	191897-9	0088381117319	12,10



# Serras tico-tico



# Serras tico-tico 18V com motor BL sem escovas.



**DJV182 e DJV181**

**BL  
MOTOR**



**Velocidade variável.  
Coletor de pó com a  
possibilidade de ligação à  
nossa gama de aspiradores.**

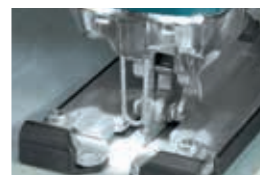







**Sistema pendular em 4 posições, para cortes rápidos.**













**LXT**  
Litho-Ion EXTREMA TECNOLOGIA  
LITHIUM-ION EXTREME TECHNOLOGY

**Símbolos e materiais**

**Materiais**

	Madeira		Corte imperfeito
	Madeira com pregos		Corte perfeito
	Aglomerado		Alumínio
	Parquet laminado		Aço inoxidável
	Plástico reforçado com fibra de vidro		Painel Sandwich
	PVC (plástico)		Vidro, cerâmica
	Metal		Borracha, couro, material isolante

**Tipo de lâmina**

		Qualidade do material da serra		Longa duração
				Lâmina extremamente afiada
	Corte reto		CORTE RÁPIDO	Corte rápido
	Corte curvo		DUO	Lâmina dupla
	Dentado com dentes inclinados		COMBO	Combinado



## Corte Super Express



Tipo	Descrição	Dentes por polegada	Comp. útil (mm)	Qualidade do material	Madeira	Plástico	Alumínio	Metal inox	Metal não ferroso	Metal	Tipo Classe B	Unds. embalagem	Código	EAN	P.V.P (€)
B-50	Com alto desempenho nas serras tico-tico a bateria: madeira e plástico.	8 - 11	73	HCS	5,5	5,5	-	-	-	-	T234X	5	B-06460	0088381276702	8,60



B-51	Com alto desempenho nas serras tico-tico a bateria: metal.	10 - 18	73	HHS	-	-	-	1,3	-	1,8	T123X	5	B-06476	0088381276719	8,60
------	--	---------	----	-----	---	---	---	-----	---	-----	-------	---	---------	---------------	------



B-52	Com alto desempenho nas serras tico-tico a bateria: universal	6 - 10	73	HHS	5,5	5,5	-	-	-	-	T345XF	5	B-06482	0088381276726	10,20
------	---	--------	----	-----	-----	-----	---	---	---	---	--------	---	---------	---------------	-------



-	Conjunto Super Express	-	77	HHS	-	-	-	-	-	-	-	3	B-06292	0088381249713	6,80
---	------------------------	---	----	-----	---	---	---	---	---	---	---	---	---------	---------------	------

## Corte básico - Madeira



Tipo	Descrição	Dentes por polegada	Comp. útil (mm)	Qualidade do material	Madeira	Plástico	Alumínio	Metal inox	Metal não ferroso	Metal	Tipo Classe B	Unds. embalagem	Código	EAN	P.V.P (€)
B13	Para cortes em madeira e plástico.	8	75	HCS	4-65	4-65	-	-	-	-	T111C	5	A-85656	0088381149563	4,50



B15	Para madeira prensada e painéis de fibra de até 3 mm, plásticos até 35 mm.	12	50	HCS	3-35	3-35	-	-	-	-	T119B	5	A-85678	0088381149655	4,20
-----	--	----	----	-----	------	------	---	---	---	---	-------	---	---------	---------------	------



B14	Para madeira prensada e painéis de fibra de até 8 mm, plásticos até 35 mm (corte rápido).	18	51	HCS	2-35	2-35	-	-	-	-	-	5	A-85662	0088381149648	4,20
-----	---	----	----	-----	------	------	---	---	---	---	---	---	---------	---------------	------







B18	Ideal para cortes curvos em madeira e plástico.	14	44	HCS	2-35	2-35	-	-	-	-	T119BO	5	A-85709	0088381149662	4,80
-----	---	----	----	-----	------	------	---	---	---	---	--------	---	---------	---------------	------







**Corte rápido - Madeira**



Tipo	Descrição	Dentes por polegada	Comp. útil (mm)	Qualidade do material	Madeira	Plástico	Alumínio	Metal inox	Metal não ferroso	Metal	Tipo Classe B	Unds. embalagem	Código	EAN	P.V.P (€)
B-16		6	75	HCS	5-65	5-65	-	-	-	-	T144D	5	A-85684	0088381149686	6,00
B16	Para corte rápido em madeira e plástico. Corte rápido e grosseiro.	6	75	HCS	5-65	5-65	-	-	-	-	T144D	5	A-85684	0088381149686	6,00
L02		6	100	HCS	5-90	5-90	-	-	-	-	-	5	A-86309	0088381150279	8,60
L02	Ideal para cortes rápidos em materiais grossos.	6	100	HCS	5-90	5-90	-	-	-	-	-	5	A-86309	0088381150279	8,60
L10		6	151	HCS	5-135	5-135	-	-	-	-	T344D	5	A-86315	0088381150286	11,80
L10	Para todos os tipos de corte em madeira. Corte rápido e grosseiro.	6	151	HCS	5-135	5-135	-	-	-	-	T344D	5	A-86315	0088381150286	11,80
B17		6	70	HCS	5-60	-	-	-	-	-	T244D	5	A-85690	0088381149693	6,20
B17	Ideal para cortes curvos em madeira e plástico (corte rápido).	6	70	HCS	5-60	-	-	-	-	-	T244D	5	A-85690	0088381149693	6,20
-		6	75	HCS/CV	8-65	-	-	-	-	-	-	5	P-31572	0088381959735	8,30
-	Corte curvo e rápido para todos os tipos de madeira.	6	75	HCS/CV	8-65	-	-	-	-	-	-	5	P-31572	0088381959735	8,30
-		6	75	BIM	8-65	-	-	-	-	-	T144DF	5	P-31588	0088381959742	10,90
-	Corte rápido em todos os tipos de madeira com uma vida útil prolongada.	6	75	BIM	8-65	-	-	-	-	-	T144DF	5	P-31588	0088381959742	10,90

**Corte madeiras laminadas**



Tipo	Descrição	Dentes por polegada	Comp. útil (mm)	Qualidade do material	Madeira	Plástico	Alumínio	Metal inox	Metal não ferroso	Metal	Tipo Classe B	Unds. embalagem	Código	EAN	P.V.P (€)
B19		12	63	HCS	3-50	3-50	-	-	-	-	T101BR	5	A-85715	0088381149709	5,90
B19	Para madeira laminada e folheado decorativo de acabamento. Dentes invertidos.	12	63	HCS	3-50	3-50	-	-	-	-	T101BR	5	A-85715	0088381149709	5,90
B28		16	63	HSS	2-50	2-50	-	-	-	-	T101BIF	5	A-80391	0088381136938	11,20
B28	Para madeira laminada e folheado decorativo de acabamento.	16	63	HSS	2-50	2-50	-	-	-	-	T101BIF	5	A-80391	0088381136938	11,20
B-53		15	82	-	-	-	-	-	-	-	T101BIF	5	B-10970	0088381351461	13,60
B-53	Para corte reto em laminados, pavimentos de madeira e madeiras decorativas. Sem lascas.	15	82	-	-	-	-	-	-	-	T101BIF	5	B-10970	0088381351461	13,60
B-54		15	82	-	-	-	-	-	-	-	T101AOF	5	B-10986	0088381351478	15,90
B-54	Para corte curvo em laminados, pavimentos de madeira e madeiras decorativas. Sem lascas.	15	82	-	-	-	-	-	-	-	T101AOF	5	B-10986	0088381351478	15,90
B16		12	60	BIM	5-20	-	-	-	-	-	T101AIF	5	P-31566	0088381959728	11,20
B16	Lâmina especial para cortes superficiais sem lascas, em soalhos laminados e parquet.	12	60	BIM	5-20	-	-	-	-	-	T101AIF	5	P-31566	0088381959728	11,20



**Corte limpo em madeira**

Tipo	Descrição	Dentes por polegada	Comp. útil (mm)	Qualidade do material	Madeira	Plástico	Alumínio	Metal inox	Metal não ferroso	Metal	Tipo Classe B	Unds. embalagem	Código	EAN	P.V.P (€)
N59	Corte rápido e limpo em todo o tipo de madeira e plástico.	8	75	HCS	4-65	4-65	-	-	-	-	T101B	5	A-86583	0088381150934	7,80
B10	Corte rápido e limpo em madeira e plástico, especialmente adequado para contraplacado.	9	75	HCS	3-65	3-65	-	-	-	-	-	5	A-85628	0088381149716	6,60
B11	Para uma rápida conclusão do trabalho. Corte limpo.	9	75	HCS	3-60	3-60	-	-	-	-	T101B	5	A-85634	0088381149549	7,00
B12	Para uma rápida conclusão do trabalho. Corte limpo.	6	75	HCS	5-65	5-65	-	-	-	-	T101D	5	A-85640	0088381149556	5,60
L01	Lâmina grossa e comprida para cortes limpos e retos.	6	100	HCS	5-90	5-90	-	-	-	-	T301CD	5	A-86290	0088381150262	12,40
B29	Ideal para o corte curvo em madeira e plástico. (acabamento).	16	42	HCS	2-35	2-35	-	-	-	-	T101AO	5	A-80400	0088381136945	10,60
BR13	Corte sem lascas em madeira, sem necessidade de lixamento. A lâmina corta para cima e para baixo para um bom acabamento superficial.	9	64	HCS	5-65	-	-	-	-	-	-	5	A-85793	0088381149679	4,80
-	Corte limpo em todos os tipos de madeira e plástico com uma vida útil prolongada.	10	75	BIM	5-65	5-65	-	-	-	-	T101BF	5	P-31594	00883811959759	11,40

**Corte - Madeiras duras**

Tipo	Descrição	Dentes por polegada	Comp. útil (mm)	Qualidade do material	Madeira	Plástico	Alumínio	Metal inox	Metal não ferroso	Metal	Tipo Classe B	Unds. embalagem	Código	EAN	P.V.P (€)
B25	Para madeira dura, para folheado.	9	75	HSS	3-60	3-60	3-6	-	-	3-6	T127D	5	A-85765	0088381149600	5,60
B26	Para cortes curvos em madeira dura, metal, metal não ferroso e plásticos duros.	9	70	HSS	3-60	3-60	3-10	-	3-10	3-10	T227D	5	A-85771	0088381149617	6,30



**Corte - Madeira com pregos**



Tipo	Descrição	Dentes por polegada	Comp. útil (mm)	Qualidade do material	Madeira	Plástico	Alumínio	Metal inox	Metal não ferroso	Metal	Tipo Classe B	Unds. embalagem	Código	EAN	P.V.P (€)
M-Force	Dente em M para o corte rápido de madeira, metais e madeira com pregos. Cortes em ambos os sentidos para aumentar a velocidade de corte.	5	130	BIM	105	-	-	-	-	-	-	2	P-45749	0088381976183	8,60



-	Ideal para madeira com pregos.	9-10	105	BIM	5-95	-	-	-	-	2,5-10	-	5	P-49638	0088381980081	12,60
---	--------------------------------	------	-----	-----	------	---	---	---	---	--------	---	---	---------	---------------	-------



-	Ideal para madeira com pregos.	9-10	75	BIM	5-65	-	-	-	-	2,5-10	T111HF	5	P-49622	0088381980074	11,20
---	--------------------------------	------	----	-----	------	---	---	---	---	--------	--------	---	---------	---------------	-------

**Corte básico - Metal**



Tipo	Descrição	Dentes por polegada	Comp. útil (mm)	Qualidade do material	Madeira	Plástico	Alumínio	Metal inox	Metal não ferroso	Metal	Tipo Classe B	Unds. embalagem	Código	EAN	P.V.P (€)
N51	Para chapas finas de aço e aço inoxidável.	24	75	HSS	-	1,5-6	1,5-6	1-3	-	1-3	-	5	A-86561	0088381150910	7,40



B22	Para aço médio, inoxidável e plásticos duros, especialmente adequado para chapas finas.	24	50	HSS	-	1-6	1-3	1-3	-	1-3	T118A	5	A-85737	0088381149570	5,60
-----	---	----	----	-----	---	-----	-----	-----	---	-----	-------	---	---------	---------------	------



B24	Para aço médio fino, inoxidável e chapas de aço muito finas.	32	50	HSS	-	1-3	1-2	0,5-2	-	0,5-2	T118G	5	A-85759	0088381149594	5,40
-----	--	----	----	-----	---	-----	-----	-------	---	-------	-------	---	---------	---------------	------

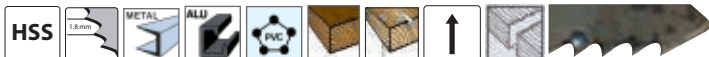

B23	Aço médio, chapa de média espessura, madeira, folheado de madeira decorativa e aço não ferroso.	14	50	HSS	3-35	3-35	2-6	-	2-6	2-6	T118B	5	A-85743	0088381149587	5,40
-----	---	----	----	-----	------	------	-----	---	-----	-----	-------	---	---------	---------------	------



B27	Para cortes curvos em aço médio e não ferroso.	24	50	HSS	-	1-6	1-3	1-3	1-3	1-3	T218A	5	A-85787	0088381149631	6,80
-----	--	----	----	-----	---	-----	-----	-----	-----	-----	-------	---	---------	---------------	------

**Corte - Metal**



Tipo	Descrição	Dentes por polegada	Comp. útil (mm)	Qualidade do material	Madeira	Plástico	Alumínio	Metal inox	Metal não ferroso	Metal	Tipo Classe B	Unds. embalagem	Código	EAN	P.V.P (€)
-	Para revestimento de 80 mm e materiais de sanduíche. (lâmina flexível)	25	105	BIM	-	-	-	-	-	1-3	T318AF	5	P-47204	0088381977630	10,60



-	Para tubos finos de materiais não ferrosos e revestimento.	13	105	BIM	-	-	-	-	2,5-6	2,5-6	T318BF	5	P-47210	0088381977647	10,00
---	--	----	-----	-----	---	---	---	---	-------	-------	--------	---	---------	---------------	-------



-	Lâmina flexível para chapa fina de aço médio e inoxidável com uma vida útil prolongada.	21	55	BIM	-	-	-	1,2-2	-	1,2-2	T118AF	5	P-47226	0088381977654	8,30
---	---	----	----	-----	---	---	---	-------	---	-------	--------	---	---------	---------------	------



**Corte - Especial Inox**



Tipo	Descrição	Dentes por polegada	Comp. útil (mm)	Qualidade do material	Madeira	Plástico	Alumínio	Metal inox	Metal não ferroso	Metal	Tipo Classe B	Unds. embalagem	Código	EAN	P.V.P (€)
-	Para aço médio e inoxidável.	24	50	CV-HM	-	-	1,5-3	1,5-3	-	1,5-3	T118A-HM	1	P-05929	0088381944441	14,30



-	Lâmina flexível para aços médio e inoxidável, metal não ferroso com uma vida útil prolongada.	14	55	BIM	-	-	2-3	2-3	-	2-3	T118BF	5	P-47232	0088381977661	8,30
---	---	----	----	-----	---	---	-----	-----	---	-----	--------	---	---------	---------------	------

**Corte - Especial plásticos**

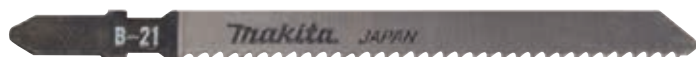

Tipo	Descrição	Dentes por polegada	Comp. útil (mm)	Qualidade do material	Madeira	Plástico	Alumínio	Metal inox	Metal não ferroso	Metal	Tipo Classe B	Unds. embalagem	Código	EAN	P.V.P (€)
B21	Para trabalhos de acabamento em plásticos e alumínio.	12	75	HSS	-	3-60	1-10	-	-	-	T101A	5	A-85721	0088381149624	9,00

**Corte - Especial materiais macios**



Tipo	Descrição	Dentes por polegada	Comp. útil (mm)	Qualidade do material	Madeira	Plástico	Alumínio	Metal inox	Metal não ferroso	Metal	Tipo Classe B	Unds. embalagem	Código	EAN	P.V.P (€)
-	Ideal para papel, cortiça, borracha e couro.	-	75	HCS	-	-	-	-	-	-	T113A	5	A-80416	0088381136952	17,70

**Corte - Especial cerâmica e fibra de vidro**



Tipo	Descrição	Dentes por polegada	Comp. útil (mm)	Qualidade do material	Madeira	Plástico	Alumínio	Metal inox	Metal não ferroso	Metal	Tipo Classe B	Unds. embalagem	Código	EAN	P.V.P (€)
-	Para cerâmica de 5 - 15 mm - corte grosseiro.	-	54	CV-HM	-	-	-	-	-	-	T130RI-FF	3	P-38788	0088381966696	15,50

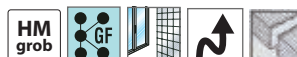

-	Para cerâmica de 5 - 20 mm - corte fino.	-	54	CV-HM	-	-	-	-	-	-	T150RI-FF	3	P-38794	0088381966702	15,50
---	--	---	----	-------	---	---	---	---	---	---	-----------	---	---------	---------------	-------



-	Para fibra de vidro e plásticos reforçados. Dentes de carboneto de tungstênio.	6	75	CV-HM	10-60	-	-	-	-	-	T141HM	3	B-06890	0088381289177	26,00
---	--	---	----	-------	-------	---	---	---	---	---	--------	---	---------	---------------	-------

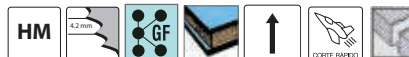

-	Para fibra de vidro e plásticos reforçados. Dentes de carboneto de tungstênio.	6	105	CV-HM	10-95	-	-	-	-	-	T341HM	3	B-06909	0088381289184	35,00
---	--	---	-----	-------	-------	---	---	---	---	---	--------	---	---------	---------------	-------

**Corte - Especial painel sandwich**



Tipo	Descrição	Dentes por polegada	Comp. útil (mm)	Qualidade do material	Madeira	Plástico	Alumínio	Metal inox	Metal não ferroso	Metal	Tipo Classe B	Unds. embalagem	Código	EAN	P.V.P (€)
-	Ideal para papel, cortiça, borracha e couro.	24	155	BIM	5-145	5-145	-	-	-	-	T718BF	5	P-49644	0088381980098	14,30

**Conjuntos de lâminas a granel**

**Para corte rápido e limpo em madeira e plásticos. Especial contraplacado**



Tipo	Descrição	Dentes por polegada	Comp. útil (mm)	Qualidade do material	Madeira	Plástico	Alumínio	Metal inox	Metal não ferroso	Metal	Tipo Classe B	Unds. embalagem	Código	EAN	P.V.P (€)
B10	Jogo de lâminas a granel	9	75	HCS	3-65	3-65	-	-	-	-	T301CD	100	B-07674	0088381335294	106,00

**Para uma rápida conclusão do trabalho. Corte limpo**



Tipo	Descrição	Dentes por polegada	Comp. útil (mm)	Qualidade do material	Madeira	Plástico	Alumínio	Metal inox	Metal não ferroso	Metal	Tipo Classe B	Unds. embalagem	Código	EAN	P.V.P (€)
B11	Jogo de lâminas a granel	9	75	HCS	3-60	3-60	-	-	-	-	T101B	100	B-07680	0088381335300	111,00

**Para corte rápido em madeira e plásticos. Corte rápido e grosseiro**



Tipo	Descrição	Dentes por polegada	Comp. útil (mm)	Qualidade do material	Madeira	Plástico	Alumínio	Metal inox	Metal não ferroso	Metal	Tipo Classe B	Unds. embalagem	Código	EAN	P.V.P (€)
B16	Jogo de lâminas a granel	6	75	HCS	5-65	5-65	-	-	-	-	T144D	100	B-07711	0088381335331	94,00

**Para aço médio, inoxidável e plásticos duros. Adequado para chapas finas**

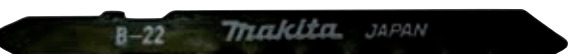

Tipo	Descrição	Dentes por polegada	Comp. útil (mm)	Qualidade do material	Madeira	Plástico	Alumínio	Metal inox	Metal não ferroso	Metal	Tipo Classe B	Unds. embalagem	Código	EAN	P.V.P (€)
B22	Jogo de lâminas a granel	24	50	HSS	-	1-6	1-3	1-3	-	1-3	T118A	100	B-07733	0088381335355	90,00

**Para cortes em madeira e plástico**



Tipo	Descrição	Dentes por polegada	Comp. útil (mm)	Qualidade do material	Madeira	Plástico	Alumínio	Metal inox	Metal não ferroso	Metal	Tipo Classe B	Unds. embalagem	Código	EAN	P.V.P (€)
B13	Jogo de lâminas a granel	8	80	HCS	4-65	4-65	-	-	-	-	T111C	100	B-07705	0088381335324	73,00



**Tipos de lâminas - Inserção Makita**

**Corte - Madeira**



Tipo	Descrição	Dentes por polegada	Comp. útil (mm)	Qualidade do material	Madeira	Plástico	Alumínio	Metal inox	Metal não ferroso	Metal	Tipo Classe B	Unds. embalagem	Código	EAN	P.V.P (€)
3	Para todos os tipos de madeira e plástico.	9	60	HCS	3-50	3-50	-	-	-	-	-	5	A-85868	88381149457	4,80

**Corte rápido - Madeira**



Tipo	Descrição	Dentes por polegada	Comp. útil (mm)	Qualidade do material	Madeira	Plástico	Alumínio	Metal inox	Metal não ferroso	Metal	Tipo Classe B	Unds. embalagem	Código	EAN	P.V.P (€)
8	Corte rápido de todos os tipos de madeira e plástico.	8	60	HCS	4-50	4-50	-	-	-	-	-	5	A-85911	88381149723	5,90

**Corte acabado - Madeira**



Tipo	Descrição	Dentes por polegada	Comp. útil (mm)	Qualidade do material	Madeira	Plástico	Alumínio	Metal inox	Metal não ferroso	Metal	Tipo Classe B	Unds. embalagem	Código	EAN	P.V.P (€)
9	Corte limpo e rápido em todos os tipos de madeira e plástico.	8	60	HCS	4-50	4-50	-	-	-	-	-	5	A-85927	0088381149730	7,50



Tipo	Descrição	Dentes por polegada	Comp. útil (mm)	Qualidade do material	Madeira	Plástico	Alumínio	Metal inox	Metal não ferroso	Metal	Tipo Classe B	Unds. embalagem	Código	EAN	P.V.P (€)
10	Corte limpo e rápido em todos os tipos de madeira e plástico. Especial para contraplacado.	9	60	HCS	4-50	4-50	-	-	-	-	-	5	A-85818	0088381149488	7,80

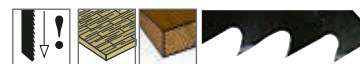

Tipo	Descrição	Dentes por polegada	Comp. útil (mm)	Qualidade do material	Madeira	Plástico	Alumínio	Metal inox	Metal não ferroso	Metal	Tipo Classe B	Unds. embalagem	Código	EAN	P.V.P (€)
BR3	Lâmina especial para cortes superficiais sem lascas.	9	60	HCS	4-50	-	-	-	-	-	-	5	A-85933	0088381149747	4,80

**Corte - Madeiras duras e contraplacados decorativos**



Tipo	Descrição	Dentes por polegada	Comp. útil (mm)	Qualidade do material	Madeira	Plástico	Alumínio	Metal inox	Metal não ferroso	Metal	Tipo Classe B	Unds. embalagem	Código	EAN	P.V.P (€)
2	Para chapas finas de aço e aço inoxidável.	14	60	HSS	3-50	3-50	2-6	-	2-6	-	-	5	A-85852	0088381149440	5,90



Tipo	Descrição	Dentes por polegada	Comp. útil (mm)	Qualidade do material	Madeira	Plástico	Alumínio	Metal inox	Metal não ferroso	Metal	Tipo Classe B	Unds. embalagem	Código	EAN	P.V.P (€)
4	Para madeira dura, metal não ferroso e plásticos duros.	9	60	HSS	3-50	3-50	3-6	-	3-6	-	-	5	A-85874	0088381149464	5,90

**Corte - Madeira**

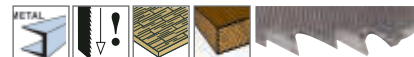

Tipo	Descrição	Dentes por polegada	Comp. útil (mm)	Qualidade do material	Madeira	Plástico	Alumínio	Metal inox	Metal não ferroso	Metal	Tipo Classe B	Unds. embalagem	Código	EAN	P.V.P (€)
41	Para cortar madeira e plástico sem lascas. Dentes invertidos.	12	60	HSS	3-50	3-50	-	-	-	-	-	5	A-85880	0088381149525	6,20



42	Lâmina especial sem inclinação para um bom acabamento em ambos os lados, laminados e painéis múltiplas.	16	60	HSS	2-50	-	-	-	-	-	-	5	A-85896	0088381149532	9,60
----	---	----	----	-----	------	---	---	---	---	---	---	---	---------	---------------	------



**Corte - Metal**



1	Para chapas finas de aço e aço inoxidável.	24	60	HSS	-	-	1-3	0,5-3	1-3	-	-	5	A-85802	0088381149433	5,90
---	--	----	----	-----	---	---	-----	-------	-----	---	---	---	---------	---------------	------



5	Para chapas finas de aço e aço inoxidável.	24	42	HSS	-	-	1-3	1-3	1-3	-	-	5	A-85905	0088381149471	6,50
---	--	----	----	-----	---	---	-----	-----	-----	---	---	---	---------	---------------	------



### Guias de carril e acessórios



Peça para unir dois carris

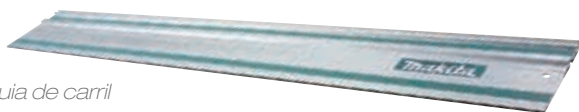

Guia de carril



Capa para guia de carril

Descrição	Comp. (m)	Unds.	Código	EAN	P.V.P (€)
Peça para unir dois carris	-	1	198885-7	0088381497046	27,00
Guia de carril	1	1	199140-0	0088381528672	48,00
	1,4	1	194368-5	0088381313353	76,00
	1,9	1	194925-9	0088381354790	117,00
	3	1	194367-7	0088381335201	198,00
Capa para guia de carril	1	1	E-05670	0088381567183	49,00
	1,4	1	E-05664	0088381567176	57,00
	1,9	1	E-10920	0088381581523	89,00
	3	1	E-10936	0088381581530	110,00

### Adaptador para guia de carril



Modelos	Unds.	Código	EAN	P.V.P (€)
4350T / CT / FCT 4351CT / FCT 4329 DJV180 / 181 / 182 JV0600	1	193517-1	0088381170659	32,00

### Chaves allen



Modelos	Unds.	Código	EAN	P.V.P (€)
4326 4327 4328 4329	1	783201-2	0088381101288	1,10
4350T/CT/FCT 4351T/CT/FCT DJV180 / 181 / 182	1	783202-0	0088381102667	1,10

### Grampo para guia de carril



Modelos	Unds.	Código	EAN	P.V.P (€)
Kit fixação da guia de carril	2	194385-5	0088381314084	30,00

### Guia lateral + circular (A + B)

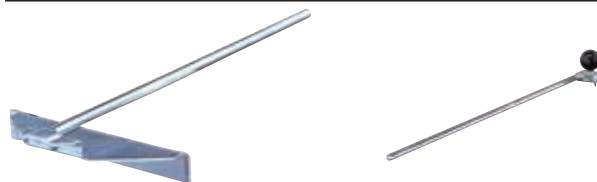

Tipo	Modelo	Unds.	Código	EAN	P.V.P (€)
A + B	DJV180 DJV181 DJV182	1	193516-3	0088381170666	10,20
A + B	4326 4327 4328 4329 JV0600 JV100D JV103	1	192732-4	0088381148054	8,80

### Acessórios

#### Placa anti-lascas



415524-7

#### Protetor de base



417852-6

#### Adaptador de aspiração



417853-4

#### Adaptador de aspiração



192349-3

Tipo	Modelo	Unds.	Código	EAN	P.V.P (€)
Placa anti-lascas	DJV182 4350T/CT/FCT 4351CT/FCT	1	415524-7	0088381131681	0,80
	4322 4323 4324	1	416477-3	0088381148207	0,55
	4329 4350T/CT/FCT 4351T/CT/FCT, DJV180 / 181 / 182 JV0600	1	417852-6	0088381177498	2,80
Adaptador de aspiração	4326 4327 4328 4329 JV0600	1	192349-3	0088381126229	8,20
	4350T/CT/FCT 4351CT/FCT DJV180	1	417853-4	0088381170833	1,10



# Fresagem



**Fresas - Índice**

**Fresas retas**



**Fresas molduradoras com rolamento 2 fios**



**Fresas para painéis com rolamentos**



**Fresas biseladoras com rolamento 2 fios**



**Fresas para ranhuras**



**Fresas molduradoras com rolamento 2 fios**



**Fresas biseladoras**

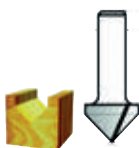

**Estojos de fresas**



**Fresas de cauda de andorinha**

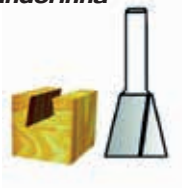

**Fresas para perfurar alumínio**

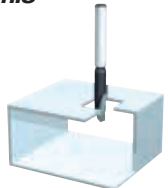

**Fresas redondeadoras**



**Fresas para gesso cartonado ou pladur**



**Fresas redondeadoras de cantos com rolamento**



**Fresas TCT**



**Fresas retas 1 fio**

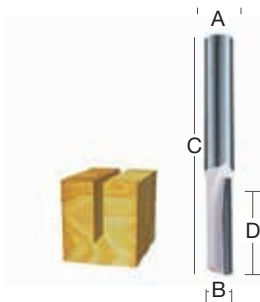

A (mm)	B (mm)	C (mm)	D (mm)	Unds.	Código	EAN	P.V.P (€)
8,0	6,0	50,8	19,0	1	D-67692	0088381549592	5,60
6,0	6,0	50,8	19,0	1	D-67701	0088381549608	5,60

**Fresas retas 2 fios**

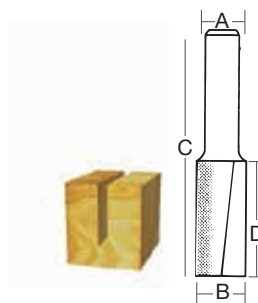

A (mm)	B (mm)	C (mm)	D (mm)	Unds.	Código	EAN	P.V.P (€)
6,0	6,0	48,0	16,0	1	D-67717	0088381549615	5,90
6,0	8,0	51,0	19,0	1	D-67739	0088381549639	6,70
6,0	8,0	57,1	25,4	1	D-67745	0088381549646	6,40
6,0	10,0	57,4	25,4	1	D-67751	0088381549653	6,70
6,0	12,0	64,0	32,0	1	D-67767	0088381549660	8,60
6,0	14,0	51,0	19,0	1	D-67773	0088381549677	7,80
6,0	20,0	50,8	19,0	1	D-67789	0088381549684	10,40
8,0	6,0	51,0	19,0	1	D-67804	0088381549707	6,20
8,0	8,0	51,0	19,0	1	D-67810	0088381549714	6,70
8,0	10,0	51,0	19,0	1	D-67826	0088381549721	7,00
8,0	12,0	51,0	19,0	1	D-67832	0088381549738	6,70
8,0	14,0	51,0	19,0	1	D-67848	0088381549745	8,00
8,0	16,0	50,8	19,0	1	D-67854	0088381549752	8,80
8,0	18,0	50,8	19,0	1	D-67860	0088381549769	10,20
8,0	20,0	50,8	19,0	1	D-67876	0088381549776	10,40
8,0	22,0	57,2	25,4	1	D-67882	0088381549783	11,50
8,0	24,0	57,2	25,4	1	D-67898	0088381549790	14,40
12,0	8,0	69,8	25,0	1	D-67907	0088381549806	7,50
12,0	10,0	69,8	25,4	1	D-67913	0088381549813	7,80
12,0	12,0	73,0	32,0	1	D-67929	0088381549820	8,80
12,0	14,0	73,0	32,0	1	D-67935	0088381549837	10,20
12,0	16,0	73,0	32,0	1	D-67941	0088381549844	11,00
12,0	19,0	73,0	32,0	1	D-67957	0088381549851	13,10
12,0	22,0	73,0	32,0	1	D-67963	0088381549868	14,40
12,0	25,0	73,0	32,0	1	D-67979	0088381549875	15,50



**Fresas para madeira HM/CT**

**Fresas para painéis com rolamento 2 fios**

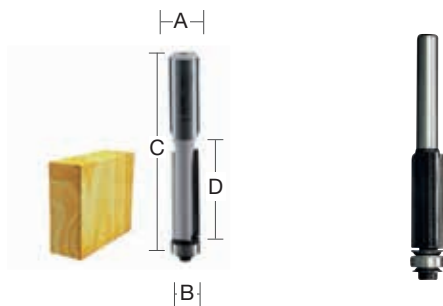

A (mm)	B (mm)	C (mm)	D (mm)	Unds.	Código	EAN	P.V.P (€)
6,0	9,5	66,9	26,0	1	D-67985	0088381549882	7,80
8,0	12,7	55,5	13,0	1	D-68024	0088381549929	8,00
8,0	12,7	68,5	26,0	1	D-68030	0088381549936	8,30

**Fresas para painéis com rolamento 3 fios**

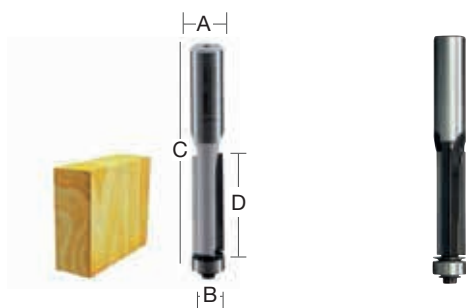

A (mm)	B (mm)	C (mm)	D (mm)	Unds.	Código	EAN	P.V.P (€)
8,0	12,7	68,5	26,0	1	D-68046	0088381549943	11,80
12,0	12,7	91,2	38,0	1	D-68052	0088381549950	14,20

**Fresas para ranhuras 2 fios**

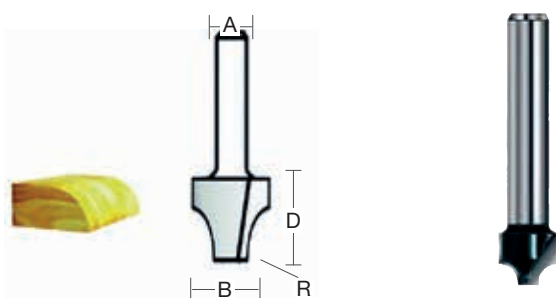

A (mm)	B (mm)	C (mm)	D (mm)	R (mm)	Unds.	Código	EAN	P.V.P (€)
6,0	6,4	44,5	12,7	3,2	1	D-68096	0088381549998	5,90

**Fresas biseladoras 2 fios 90°**

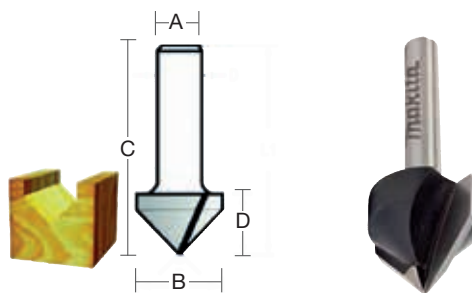

A (mm)	B (mm)	C (mm)	D (mm)	Unds.	Código	EAN	P.V.P (€)
6,0	19,0	47,7	16,0	1	D-68177	0088381550079	8,80
8,0	12,7	44,7	12,7	1	D-68183	0088381550086	7,00
8,0	15,9	44,0	12,7	1	D-68199	0088381550093	7,80
12,0	12,7	54,0	12,7	1	D-68208	0088381550109	7,20
12,0	15,9	50,8	12,7	1	D-68214	0088381550116	8,00
8,0	19,0	47,6	16,0	1	D-68220	0088381550123	8,80
12,0	19,0	57,1	16,0	1	D-68236	0088381550130	13,40
12,0	28,6	60,3	22,2	1	D-68242	0088381550147	18,70

**Fresas de cauda de andorinha 2 fios**

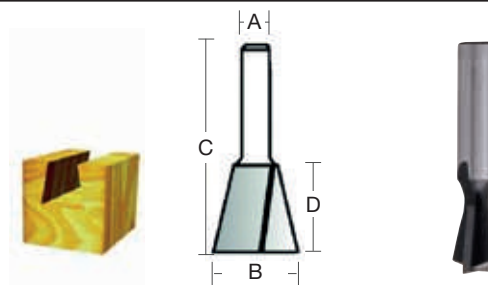

A (mm)	B (mm)	C (mm)	D (mm)	Ang.	Unds.	Código	EAN	P.V.P (€)
8,0	12,7	45,0	13,0	14°	1	D-68323	0088381550222	6,70
8,0	15,0	52,0	14,3	15°	1	D-68339	0088381550239	8,00
12,0	19,0	63,5	22,2	7°	1	D-68345	0088381550246	10,40
12,0	25,4	64,0	22,2	14°	1	D-68351	0088381550253	12,60

**Fresas redondeadoras de canto 2 fios**

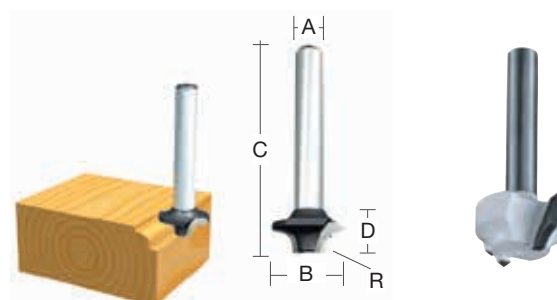

A (mm)	B (mm)	C (mm)	D (mm)	R (mm)	Unds.	Código	EAN	P.V.P (€)
6,0	19,0	42,5	9,5	3,2	1	D-68373	0088381550277	7,50
6,0	25,4	45,5	13,5	6,4	1	D-68389	0088381550284	11,20



**Fresas para madeira**

**Fresas redondeadoras de cantos com rolamento 2 fios**

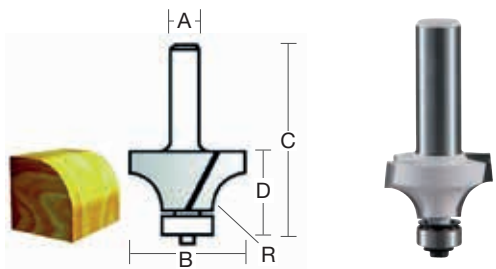

A (mm)	B (mm)	C (mm)	D (mm)	R (mm)	Unds.	Código	EAN	P.V.P (€)
6,0	19,0	53,4	9,5	3,2	1	D-68395	0088381550291	9,40
6,0	25,4	56,4	13,5	6,4	1	D-68410	0088381550314	13,10
6,0	31,8	59,7	16,7	9,5	1	D-68432	0088381550338	16,60
8,0	19,0	53,4	9,5	3,2	1	D-68454	0088381550352	9,40
8,0	25,4	56,4	13,5	6,4	1	D-68482	0088381550383	13,10
8,0	31,8	59,7	16,7	9,5	1	D-68507	0088381550406	16,60

**Fresas molduradoras com rolamento 2 fios**

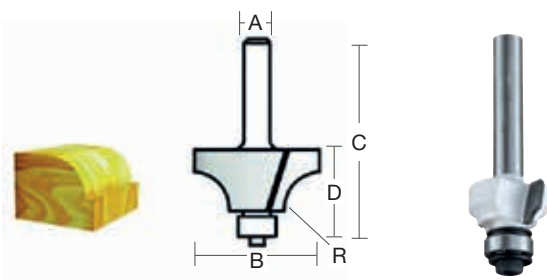

A (mm)	B (mm)	C (mm)	D (mm)	R (mm)	Unds.	Código	EAN	P.V.P (€)
6,0	20,3	50,5	10,0	4,0	1	D-68557	0088381550451	11,50
6,0	22,2	53,2	12,7	4,8	1	D-68563	0088381550468	11,80
6,0	28,6	55,5	14,5	7,9	1	D-68579	0088381550475	14,20
8,0	19,0	51,6	9,5	3,2	1	D-68591	0088381550499	9,40
8,0	31,8	57,9	17,0	9,5	1	D-68622	0088381550529	16,60

**Fresas molduradoras com rolamento 2 fios**

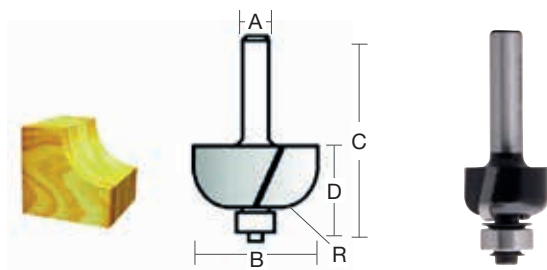

A (mm)	B (mm)	C (mm)	D (mm)	R (mm)	Unds.	Código	EAN	P.V.P (€)
8,0	22,2	55,6	12,7	4,8	1	D-68666	0088381550567	11,20

**Fresas biseladoras com rolamento 2 fios**

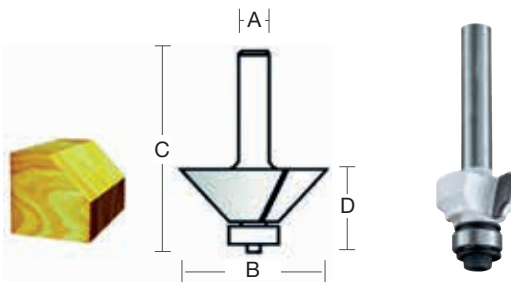

A (mm)	B (mm)	C (mm)	D (mm)	Ang.	Unds.	Código	EAN	P.V.P (€)
6,0	25,4	51,0	11,0	45°	1	D-68694	0088381550598	12,80
6,0	22,2	56,1	12,7	25°	1	D-68703	0088381550604	10,70
8,0	30,2	54,7	12,7	45°	1	D-68719	0088381550611	15,20
12,0	44,5	68,6	22,6	45°	1	D-68753	0088381550659	24,00

**Fresas molduradoras com rolamento 2 fios**

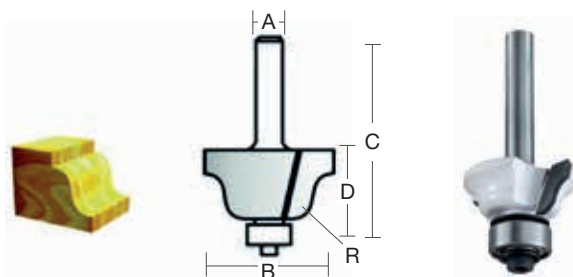

A (mm)	B (mm)	C (mm)	D (mm)	R (mm)	Unds.	Código	EAN	P.V.P (€)
6,0	28,6	55,3	13,0	4,0	1	D-68775	0088381550673	12,30
8,0	28,6	55,3	13,0	4,0	1	D-68781	0088381550680	13,10

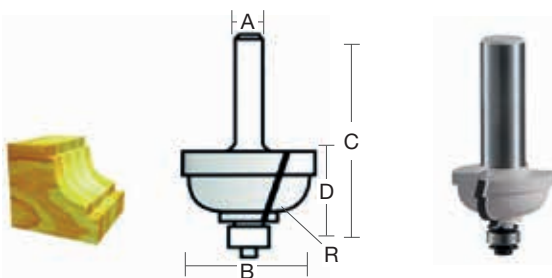

A (mm)	B (mm)	C (mm)	D (mm)	R (mm)	Unds.	Código	EAN	P.V.P (€)
6,0	25,4	53,7	12,7	4,8	1	D-68806	0088381550703	13,60

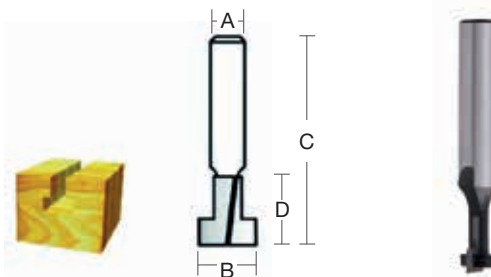

A (mm)	B (mm)	C (mm)	D (mm)	Unds.	Código	EAN	P.V.P (€)
8,0	9,5	48,0	10,5	1	D-68812	0088381550710	5,90



**Fresas para madeira**

**Conjunto de fresas**

- Conjuntos com diferentes tipos de fresas para várias aplicações.

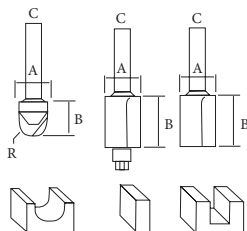

A (mm)	B (mm)	C (mm)	Tipo	Unds.	Código	EAN	P.V.P (€)
-	-	6	HM	3	D-30209	88381352772	23,00
-	-	6	HM				
-	-	6	HM				

**Jogo de fresas multiusos (22pcs)**



D	A (mm)	B (mm)	C (mm)	R (mm)	Fios	Unds.	Código	EAN	P.V.P (€)
51	20	19	8	-	2	22	D-74778	0088381590228	214,00
51	16	19	8	-	2				
51	12	19	8	-	2				
51	10	19	8	-	2				
51	8	19	8	-	2				
51	6	19	8	-	1				
51	4	13	8	-	1				
51	3	13	8	-	1				
51	17,3	8	8	2,3	2				
53,4	19	9,5	8	3,2	2				
56,5	25,4	13,5	8	6,35	2				
55	22,2	12,7	8	4,8	2				
54,5	30,2	12,7	8	-	2				
55,6	22,2	12,7	8	4,8	2				
41,5	12,7	10	8	6,35	2				
48	12,7	16	8	-	2				
44,7	12,7	12,7	8	-	2				
67	9,5	26	8	-	2				
68,5	12,7	26	8	-	2				
52	15	14,3	8	-	2				
54,6	31,8	12,2	8	-	2				
65	6,35	19	8	-	1				



**Jogo de fresas multiusos (22pcs)**



D	A (mm)	B (mm)	C (mm)	R (mm)	Fios	Unds.	Código	EAN	P.V.P (€)
51	12	19	8	-	2	22	D-74784	0088381590235	144,00
51	10	19	8	-	2				
51	8	19	8	-	2				
51	6	19	8	-	2				
48	6	16	8	-	2				
51	6	19	8	-	1				
48	5	13	8	-	1				
38,3	6,35	6,35	8	3,2	2				
40	7,9	8	8	4	2				
41,5	12,7	10	8	6,35	2				
41,3	9,5	9,5	8	4,8	2				
48	12,7	16	8	-	2				
44,7	12,7	12,7	8	-	2				
67	9,5	23	8	-	2				
45	12,7	13	8	-	2				
40	9,5	9,5	8	-	2				
63,5	6,35	8	8	-	2				
65	6,35	19	8	-	1				
44,5	6,35	12,7	8	3,2	2				
44,5	9,5	12,7	8	4,8	2				
48	9,5	10,5	8	-	2				
41,3	9,5	8,3	8	4,8	2				



Fresas para madeira

Caixas de fresas

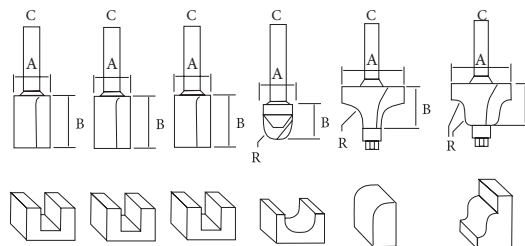

A (mm)	B (mm)	C (mm)	Unds.	Código	EAN	P.V.P (€)
6	16	8	12	D-53556	0088381449922	137,00
16	19	8				
12,7	13	8				
12,7	10	8				
12,7	16,7	8				
12,7	13,5	8				
12	19	8				
12,7	13	8				
12,7	12,7	8				
-	13,5	8				
-	14	8				
-	13	8				



A (mm)	B (mm)	C (mm)	R (mm)	Unds.	Código	EAN	P.V.P (€)
6	16	8	-	6	D-53540	0088381449915	70,00
10	19	8	-				
12	19	8	-				
12,7	10	8	6,35				
31,8	16,7	8	9,5				
28,6	13	8	4				

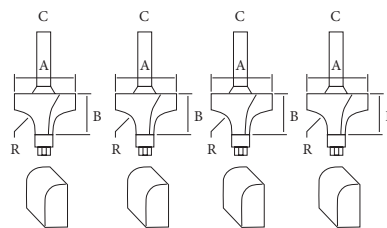

A (mm)	B (mm)	C (mm)	Unds.	Código	EAN	P.V.P (€)
6	19	6	12	D-57065	0088381459693	118,00
12	32	6				
12,7	13	6				
12,7	12,7	6				
12,7	13,5	6				
12,7	11	6				
6	16	6				
14	19	6				
6,35	12,7	6				
19	9,5	6				
-	14,5	6				
-	9,5	6				



A (mm)	B (mm)	C (mm)	R (mm)	Unds.	Código	EAN	P.V.P (€)
19	9,5	8	3,2	4	D-53534	88381449908	67,00
25,4	13,5	8	6,35				
31,8	16,7	8	9,5				
38,1	19	8	38,1				



**Fresas para perfurar alumínio**

- Ferramenta de corte HM.
- Para perfuração de alumínio.
- Também adequada para recortes em alumínio.

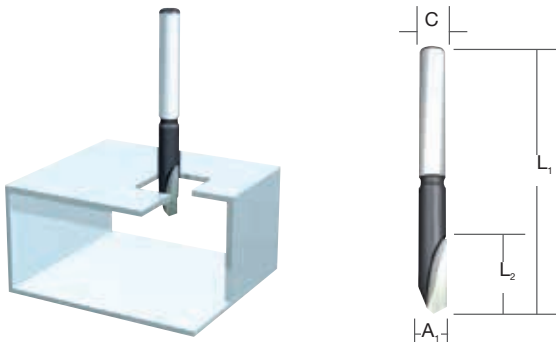

A1/ A2 (mm)	L1 (mm)	L2 (mm)	C (mm)	Tipo	Unds.	Código	EAN	P.V.P (€)
6	65	30	6	HM	1	D-16988	0088381194761	11,60



**Fresas para 3706, DCO180 e DCO181**

**Fresas para gesso cartonado ou pladur**



Inserção (mm)	Modelo	Unds.	Código	EAN	P.V.P (€)
3,18 (1/8")	3706 DCO180 DCO181	1	733240-2	-	3,90
6,35 (1/4")		1	733232-1	0088381160544	14,50
3,18 (1/8") (multiuso)		1	193483-2	0088381163927	5,50

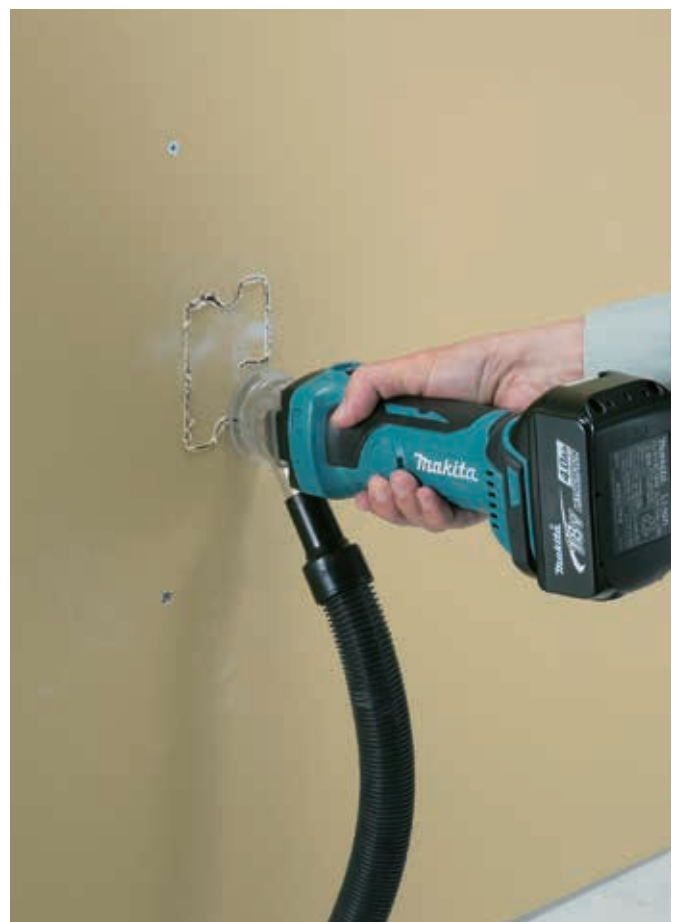

Acessórios para PJ7000 e 3901

Discos HM



Ø (mm)	Modelo	Unds.	Código	EAN	P.V.P (€)
100	PJ7000 3901	1	B-20644	0088381377133	26,00

Acessórios para 7104

Correntes



Barra-guia



Tipo	Medida (mm)	Modelo	Unds.	Código	EAN	P.V.P (€)
-	15	7104L	1	A-16564	0088381131612	392,00
-	16,5		1	A-16570	0088381131629	389,00
-	18,0		1	A-16586	0088381131636	411,00
-	21		1	A-16592	0088381131643	460,00
-	24,0		1	A-16601	0088381131650	528,00
Usar com o pinhão cod. 221502-5 e barra cod.122235-4.	30		1	A-16617	0088381131667	810,00

Corrente	Descrição Tipo/Utilização	Unds.	Código	EAN	P.V.P (€)
30mm	Usar ao montar a corrente de 30 mm.	1	122235-4	0088381122764	341,00

Pinhão



Corrente	Descrição Tipo/Utilização	Unds.	Código	EAN	P.V.P (€)
30 mm	Usar ao montar a corrente de 30 mm.	1	221502-5	-	18,90

Óleo de corrente



Unds.	Código	EAN	P.V.P (€)
1	181434-7	0088381194747	1,35





**Guia de ângulo**



Modelo	Unds.	Código	EAN	P.V.P (€)
PJ7000 DPJ180 BPJ180	1	123149-0	0088381443173	21,00

**Placa de ajuste**



Modelos	Unds.	Código	EAN	P.V.P (€)
3901 PJ7000 DPJ180	1	415579-2	0088381155038	8,00

**Chaves de pivôs 20**



Modelos	Unds.	Código	EAN	P.V.P (€)
3901 PJ7000 DPJ180 BPJ180	1	782401-1	0088381101240	0,95

**Saco coletor de pó**



Modelos	Unds.	Código	EAN	P.V.P (€)
3901	1	122474-6	0088381127547	7,60
PJ7000 DPJ180 BPJ180	1	123150-5	0088381403092	7,00

**Casquilhos cónicos**



Modelo	Ø (mm)	Descrição	Unds.	Código	EAN	P.V.P (€)
3707FC	6	-	1	763607-0	0088381114806	2,80
	6,35 20,00	-	1	763608-8	0088381102292	3,30
3709 3710 4403	6	-	1	763662-2	0088381431606	4,10
	6,35 (1/4")	-	1	763663-0	0088381207294	4,40
RP1800 RP2300FC	1/2"	-	1	763622-4	0088381102315	16,50
	12	-	1	763628-2	0088381114813	16,50
	13	-	1	763632-1	0088381118538	26,00
3601B	12	-	1	763601-2	0088381123945	41,00
DRT50 RP0900 RT0700C RT0702C	6	-	1	763636-3	0088381142830	11,60
	6,35 (1/4")	-	1	763637-1	0088381102353	9,60
	8	-	1	763618-5	0088381114820	2,80
RP0910 RP110C	6	Com porca	1	193180-0	0088381156714	26,00
	8	Com porca	1	193178-7	0088381156721	22,00

**Chaves**



Redução (mm)	Modelo	Unds.	Código	EAN	P.V.P (€)
8	RP0910 RP110C RP0900	1	781213-9	0088381102520	2,20
13	DRT50 RP0700C RT0702C RP0900	1	781006-4	0088381102407	1,95
17	3709 3710 3706 3707FC RP0910 RP110C 4403	1	781008-0	0088381102414	1,95
22	DRT50 RP0900 RT0700C RT0702C	1	781011-1	0088381102438	2,20
23	3601B	1	781012-9	0088381102445	2,30
24	RP1800 RP2300FC	1	781030-7	0088381151559	2,80



Casquilho redutor



Reducción (mm)	Modelo	Unds.	Código	EAN	P.V.P (€)
12 - 6 "	3601B RP1800 RP2300FC	1	763801-4	008838114646	3,30
12 - 8 "		1	763804-8	008838114653	3,30
12 - 10 "		1	763807-2	008838124003	3,90
12 - 1/4 "		1	763803-0	0088381102360	3,30

Porca



Modelos	Unds.	Código	EAN	P.V.P (€)
3707FC 3709 3710 4403	1	763606-2	0088381123952	4,10
RP0900 RT0700C RT0702C	1	763615-1	0088381123969	3,30
RP0910 RP110C	1	763652-5	0088381170352	4,40
3612 3612C	1	763629-0	0088381123983	6,60
RP1800 RP2300FC	1	763674-5	-	7,20

Acessórios para 3706, DCO180 e DCO181



Guia circular



Modelos	Unds.	Código	EAN	P.V.P (€)
3706 DCO180 DCO181	1	193448-4	0088381163958	26,00

Coletor de pó



Modelos	Unds.	Código	EAN	P.V.P (€)
3706 DCO180 DCO181	1	193449-2	0088381160490	7,20

Casquilhos cónicos



Medida (mm)	Modelo	Unds.	Código	EAN	P.V.P (€)
3,18	3706	1	324149-5	0088381161060	11,80
6,35 (1/4")		1	763608-8	0088381102292	3,30
3,18	DCO180 DCO181	1	763677-9	0088381468824	13,20
6,35 (1/4")		1	763676-1	0088381469012	16,00

Porca



Modelos	Unds.	Código	EAN	P.V.P (€)
3706	1	763606-2	0088381123952	4,10
DCO180 DCO181	1	763258-9	-	5,80



Guias de molde

1



1. Para modelos 3709, 3710, 3707FC, DRT50, RT0700C e RT0702C.

A (mm)	B (mm)	C (mm)	Modelos	Unds.	Código	EAN	P.V.P (€)
8,0	10,0	9,5	3709 3710 3707FC DRT50 RT0700C RT0702C	1	343577-5	0088381115681	0,80

2

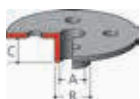

2. Para modelos DRT50, RP0900, RP1800X, RP2300FCX, RT0700\* e RT0702C.

A (mm)	B (mm)	C (mm)	Modelos	Unds.	Código	EAN	P.V.P (€)
7,7	9,5	11,5	DRT50 RP0900 RP1800X RP2300FCX RT0700* RT0702C*	1	164379-4	0088381111676	14,90
9,0	11,0	13,0		1	164775-6	0088381111720	13,80
10,0	12,0	9,0		1	164388-3	0088381156356	12,70
11,0	12,7	13,0		1	164776-4	008838112062	14,30
14,5	16,0	13,0		1	344364-5	0088381141222	2,80
18,0	20,0	13,0		1	164393-0	0088381111683	23,00
24,0	27,0	13,0		1	164470-8	0088381111690	18,00
25,0	29,0	150,0		1	163080-8	0088381111645	11,60
27,0	30,0	13,0		1	164471-6	0088381111706	11,80
37,0	40,0	11,5		1	165046-4	0088381161237	17,10

\* Com base de superfície

3



3. Para modelos RP0910 e RP1110C.

A (mm)	B (mm)	C (mm)	Modelos	Unds.	Código	EAN	P.V.P (€)
9,0	11,0	11,5	RP0910 RP1110C	1	193331-5	0088381159906	14,30
10,5	12,0	14,0		1	193332-3	0088381156615	10,20
14,5	16,0	11,5		1	193334-9	0088381159920	11,60
18,0	20,0	13,0		1	193335-7	0088381159937	17,30
22,0	14,0	13,0		1	193340-4	0088381159982	14,30
24,0	27,0	13,0		1	193336-5	0088381159944	13,20
27,0	30,0	13,0		1	193338-1	0088381159968	13,80
37,0	40,0	13,0		1	193339-9	0088381159975	15,40

Guia de molde completa

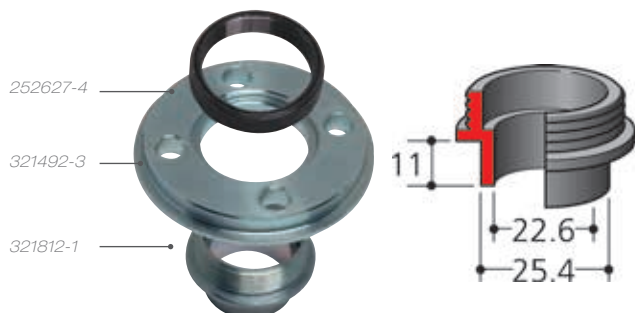

Modelo	Ø (mm)	Modelos	Unds.	Código	EAN	P.V.P (€)
Porca	M30	DRT50 RP0900 RP1800X RP2300FCX RT0700* RT0702C*	1	252627-4	0088381111782	11,00
Adaptador	-		1	321492-3	0088381111799	16,50
Casquilho	25,4mm		1	321812-1	0088381111805	10,80

\* Com base de superfície

**Guias de carril e acessórios**



Peça para unir dois carris

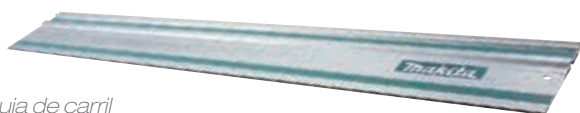

Guia de carril



Capa para guia de carril

Descrição	Comprimento (m)	Unds.	Código	EAN	P.V.P (€)
Peça para unir dois carris	-	1	198885-7	0088381497046	27,00
Guia de carril	1	1	199140-0	0088381528672	48,00
	1,4	1	194368-5	0088381313353	76,00
	1,9	1	194925-9	0088381354790	117,00
	3	1	194367-7	0088381335201	198,00
Capa para guia de carril	1	1	E-05670	0088381567183	49,00
	1,4	1	E-05664	0088381567176	57,00
	1,9	1	E-10920	0088381581523	89,00
	3	1	E-10936	0088381581530	110,00

**Grampos para guia de carril**



Descrição	Unds.	Código	EAN	P.V.P (€)
Jogo de fixação para guia de carril.	2	194385-5	0088381314084	30,00

**Adaptador para guia de carril**



Modelos	Unds.	Código	EAN	P.V.P (€)
RP0910 RP110C RP1800 RP2300FC RP0900 RT0700* RT0702C* RP2303FCXJ RP1802X	1	194579-2	0088381352611	39,00

\* Com base de superfície



Acessórios para fresadora multifunções RT0700C e DRT50

**Base reta**

**Placa para base**



\* Inclui placa base

Descrição	Modelo	Unds.	Código	EAN	P.V.P (€)
Base	DRT50 RT0700C RT0702C RT001G	1	196613-4	0088381446136	28,00
Placa para base		1	454842-8	-	2,65



**Base para superfície**

**Placa para base**



\* Inclui placa base

Descrição	Modelo	Unds.	Código	EAN	P.V.P (€)
Base	DRT50 RT0700C RT0702C	1	195563-0	0088381376099	75,00
Placa para base		1	450819-1	-	3,40
Base das duas mãos imersão	RT001G	1	199201-6	0088381528641	83,00
Base eixo deslocado		1	196093-4	0088381406482	89,00



**Base inclinável 30° a 45°**

**Placa para base**



\* Inclui placa base

Descrição	Modelo	Unds.	Código	EAN	P.V.P (€)
Base	DRT50 RT0700C RT0702C	1	198987-9	0088381525848	33,00
Placa para base		1	413150-6	-	2,85
Base inclinável	RT001G	1	199202-4	-	35,00



**Base eixo deslocado**

**Placa para base**



\* Inclui placa base

Descrição	Modelo	Unds.	Código	EAN	P.V.P (€)
Base	DRT50 RT0700C RT0702C	1	195562-2	0088381376082	88,00
Placa para base		1	413148-3	3240890370846	5,05
Base eixo deslocado	RT001G	1	196093-4	0088381406482	89,00



## Guias de corte

1



2



3



Tipo	Modelo	Unds.	Código	EAN	P.V.P (€)
1	3709 3710 DRT50 RT0700C RT0702C	1	122703-7	0088381207300	6,00
	RP1800X RP2300FCX				
3	RP0900 RT0700C** RT0702C** DRT50** RT001G**	1	STEX122385	0088381111164	39,00
	3601B				

\* Requer a utilização de batente ajustável

\*\* Com base de superfície

## Batente ajustável



122700-3

195564-8

Modelos	Unds.	Código	EAN	P.V.P (€)
RP1800 RP2300FC	1	122700-3	0088381347327	18,70
DRT50 RT0700C RT0702C	1	195564-8	0088381411530	6,50

Para instalação de um guia de corte.

## Adaptadores de aspiração



Modelos	Unds.	Código	EAN	P.V.P (€)
3612 3612C	1	415412-8	0088381155014	5,40
RP1800X RP2300FCX RP1802X RP2303FCX	1	194934-8	0088381356756	11,60
DRT50* RP0900 RT0700C* RT0702C*	1	194733-8	0088381358972	3,00
DRT50 RT0700C RT0702C RT001G	1	195559-1	0088381411295	3,60

\* Com base de superfície

## Bases



**Base reta**

**Base inclinada**

Tipo	Modelo	Unds.	Código	EAN	P.V.P (€)
Base reta	3707/F/FC	1	123544-4	-	35,00
Base inclinada		1	193904-4	0088381164726	49,00
Base reta com borracha	3709 3710	1	194268-9	0088381248846	14,00
Base reta		1	194267-1	0088381248839	16,60
Base inclinada		1	194270-2	0088381248860	44,00

## Guias paralelas



Guia paralela com ajuste milimétrico

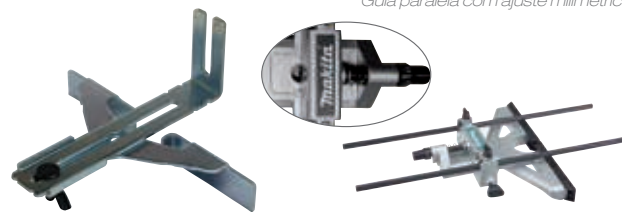

195136-9

Modelos	Unds.	Código	EAN	P.V.P (€)
3707FC 3709 3710 DRT50 RT0700C RT0702C	1	122391-0	0088381115674	6,70
RP0900 RP0910 RP1100C	1	164834-6	0088381111737	4,50
3612C 3612	1	342428-9	0088381115667	7,30
DRT50* RP0900 RT0700* RT0702C* RP1100C RP1800 RP2300FCX RP1802X RP2303FCX	1	195136-9	0088381360623	57,00

# *Decapar*



Acessórios para decapadores HG5030 - HG6031V - HG6531C - DHG180 - DHG181

Descrição		HG5030K	HG6031VK	HG6531VK	DHG180	DHG181	Unds.	Código	EAN	P.V.P (€)
		✓	✓	✓	✓	✓	1	PR00000029	0088381527934	8,20
		✓	✓	✓	✓	✓	1	PR00000028	0088381527927	8,20
		✓	✓	✓	✓	✓	1	PR00000030	0088381527941	10,50
		-	✓	✓	✓	✓	1	PR00000031	0088381527958	8,80
		-	-	✓	-	-	1	PR00000039	0088381528030	9,60
		-	-	✓	✓	✓	1	PR00000032	0088381527965	17,40
		-	-	✓	✓	✓	1	PR00000033	0088381527972	19,20
		-	-	✓	✓	✓	1	PR00000034	0088381527989	8,20
		✓	✓	✓	✓	✓	1	PR00000035	0088381527996	11,10
		✓	✓	✓	✓	✓	1	PR00000041	0088381528054	22,00



**HG5030**



**HG6031V**



**HG6531C**



**DHG180**



**DHG181**



# Parafusos e pregos



Aparafusadoras auto-alimentadas, pregadoras e agrafadoras Makita



**Pente de parafusos para auto-alimentadas**



**Parafuso para gesso cartonado sobre guia metálica**



Ø (mm)	Comp. (mm)	Tipo de rosca	Tratamento	BFR440	BFR550	6842	6844	uds.	Código	EAN	P.V.P. (€)
3,5	25	Fina	Fosfatado	✓	✓	X	X	1.000	F-31227	0088381291781	24,00
3,5	35			✓	✓	X	X		F-31230	0088381291712	28,00
3,9	25			✓	✓	✓	X		F-30913	0088381291477	25,00
3,9	41			✓	✓	✓	X		F-31166	0088381291729	22,00

**Parafuso para gesso cartonado sobre guia de madeira**



Ø (mm)	Comp. (mm)	Tipo de rosca	Tratamento	BFR440	BFR550	6842	6844	uds.	Código	EAN	P.V.P. (€)
3,9	55	Grossa	Fosfatado	X	X	✓	✓	1.000	F-31140	0088381291705	22,00

**Parafuso anticorrosão**



Ø (mm)	Comp. (mm)	Tipo de rosca	Tratamento	BFR440	BFR550	6842	6844	uds.	Código	EAN	P.V.P. (€)
3,9	32	D/G	Anti-corrosão	✓	✓	X	X	1.000	P-38283	0088381973991	31,00



**Parafusos para aparafusadora auto-alimentada - AR410HR**

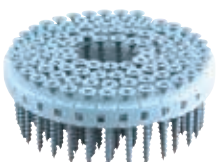

Ø cana (mm)	Ø cabeça (mm)	Comp. (mm)	Tipo	Rosca	Modelo	uds. / caixa	Código	EAN	P.V.P. (€)
3,5	8,2	41	PH2	Fina	AR410HR	2.000	F-32856	0088381293419	42,00
3,8		25		Grossa			F-32869	0088381293426	34,00



**Pregos 0,6mm (23Ga) Inox - DPT351 e DPT353**



Ø (mm)	Comp. (mm)	Tipo	Calibre	Material	Modelos	uds. / caixa	Código	EAN	P.V.P. (€)
0,6	18	Pin	23Ga	Inox	DPT351 DPT353	10.000	F-32142	0088381292702	27,00
	25						F-32155	0088381292719	31,00
	30						F-32168	0088381292726	35,00
	35						F-32171	0088381292733	40,00

**Pregos 0,6mm (23Ga) Aço - DPT351 e DPT353**



Ø (mm)	Comp. (mm)	Tipo	Calibre	Material	Modelos	uds. / caixa	Código	EAN	P.V.P. (€)
0,6	18	Pin	23Ga	Aço	DPT351 DPT353	10.000	F-31825	0088381292382	14,30
	25						F-31838	0088381292399	15,40
	30						F-31841	0088381292405	17,30
	35						F-31854	0088381292412	19,30

**Pregos 1,2mm (18Ga) - AF505N, DBN500 e DFN350**



Ø (mm)	Comp. (mm)	Tipo	Calibre	Modelos	uds. / caixa	Código	EAN	P.V.P. (€)
1,2	20	Brad	18Ga	AF505N DBN500 DFN350*	5.000	P-45923	0088381976367	12,40
	25					P-45939	0088381976374	14,10
	30					P-45945	0088381976381	16,50
	40					P-45951	0088381976398	17,70
	50					P-45967	0088381976404	21,00

\* Só até pregos de 30 mm

**Pregos multimaterial - AN250HC**

- O prego de betão tem uma guia (casquilho de plástico) que impede a inclinação do prego e permite um disparo reto, pregos de 19 a 25 mm e sem inclinação.
- Recomendações: Não pregar diretamente no betão, introduzir o prego a pelo menos 10 cm da extremidade do betão, introduzir os pregos a pelo menos 10 cm de distância. olocar los Pregos a 10 cm de distancia como mínimo.



Ø cana (mm)	Ø cabeça (mm)	Comp. (mm)	Tipo	Modelos	uds. / caixa	Código	EAN	P.V.P. (€)
2,5	6,3	22	Liso	AN250HC	1.000	F-33575	0088381294133	57,00
2,5		25				F-33588	0088381294140	59,00
3		19				F-33591	0088381294157	90,00

**Pregos multimaterial. Cada caixa contém uma lata de gás. - GN420C**



Ø (mm)	Comp. (mm)	Qualidade	Tipo	uds. GÁS	Modelos	uds. / caixa	Código	EAN	P.V.P. (€)
3,1	15	Premium	Para todos os tipos de material	1	GN420C	1.000	196285-5	0088381422932	88,00
	17						196286-3	0088381422949	88,00
	22						196287-1	0088381422956	88,00
	27						196288-9	0088381422963	88,00
	32						196289-7	0088381422970	110,00

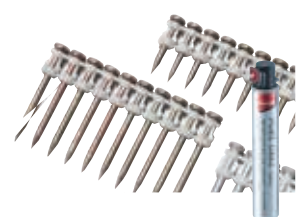

Ø (mm)	Comp. (mm)	Qualidade	Tipo	uds. GÁS	Modelos	uds. / caixa	Código	EAN	P.V.P. (€)
2,6	20	Padrão	Para todos os materiais, exceto betão	1	GN420C	1.000	196290-2	0088381422987	81,00
	25						196291-0	0088381422994	81,00
	30						196292-8	0088381423007	81,00
	35						196293-6	0088381423014	81,00
	40						196294-4	0088381423021	81,00

**Carregador de pregos - GN420C**



Modelos	uds. / caixa	uds. por carga	Código	EAN	P.V.P. (€)
GN420C	1	20	196246-5	0088381417891	215,00

**Agrafos**

**Agrafos de 90 - AT638**



Largura agrafos (mm)	Comp. (mm)	Tipo	Modelos	uds. / caixa	Código	EAN	P.V.P. (€)
1/4"	15	18Ga	AT638	5.000	P-45864	0088381976305	15,90
	18				P-45870	0088381976312	17,10
	25				P-45886	0088381976329	21,00
	30				P-45892	0088381976336	25,00
	35				P-45901	0088381976343	27,00
	38				P-45917	0088381976350	30,00

**Agrafos para máquinas a bateria**



Largura (mm)	Comp. (mm)	Modelos	uds. caixa	Código	EAN	P.V.P. (€)
--------------	------------	---------	------------	--------	-----	------------

**DST221**

10	10	DST221	5.000	F-32647	0088381293204	14,90
	13			F-32650	0088381293211	13,20
	16			F-32663	0088381293228	17,70
	19			F-32676	0088381293235	20,00
	22			F-32689	0088381293242	21,00

**ST113D e DST112**

10	7	ST113D DST112	25.000	F-81518	0088381342308	25,00
	10		15.000	F-81521	0088381342322	19,30

**Protetor de ponta DPT350**



Descrição	uds.	Código	EAN	P.V.P. (€)
Evita marcar a madeira durante a pregagem.	1	419525-7	0088381341097	1,55

**Recipiente de óleo**



Conteúdo	Modelos	uds.	Código	EAN	P.V.P. (€)
30 ml	Todos	1	181434-7	0088381194747	1,35



**Acessórios diversos**

**Botija de gás**



Modelos	uds.	Código	EAN	P.V.P. (€)
GN900 GN420C	1	242094-1	0088381415712	17,70

**Botija de gás**



Modelo	uds.	Código	EAN	P.V.P. (€)
GF600	1	242088-6	0088381401968	15,40

**Óculos de proteção**



Modelos	uds.	Código	EAN	P.V.P. (€)
Todos	1	195246-2	0088381365413	4,70

**Acessórios para alta pressão**

**Mangueiras - AC310H**



B-80014

Conteúdo	Modelo	uds.	Código	EAN	P.V.P. (€)
Mangueira 30m	AC310H	1	B-80020	0088381350761	316,00
Mangueira 15m		1	B-80014	0088381350754	215,00
Mangueira 7,5m		1	B-80036	0088381350778	175,00

**Óleo lubrificante**



Modelos	uds.	Código	EAN	P.V.P. (€)
GN900 GN420C	1	242077-1	0088381351973	11,60

**Produto de limpeza**



Modelos	uds.	Código	EAN	P.V.P. (€)
GN900 GN420C	1	242075-5	0088381351966	21,00

**Kit de limpeza**



Modelos	uds.	Código	EAN	P.V.P. (€)
GN900 GN420C GF600	1	194852-0	0088381351959	48,00

**Carro de transporte - AC310H**



Conteúdo	Modelo	uds.	Código	EAN	P.V.P. (€)
Carro de transporte	AC310H	1	HY00000212	0088381351188	207,00

# Aspiração



**HEPA**  
filtro



# Ampla gama de aspiradores a bateria Potentes - Leves - Versáteis



**LXT**  
LITIO-ION EXTREMA TECNOLOGIA

**XGT**

**CXT**



**18V**  
LITIO-ION

**BL**  
MOTOR

**CXT**

**HEPA**  
filtro

**18V X2**  
36V

**AWS**

Para mais informações, consulte o catálogo de ferramentas.





**Mecanismo de limpeza do saco do pó de papel para eficiência laboral (apenas DVC660/DVC665)**

Mesmo ao aspirar o pó de betão, ele tende a entupir os filtros. A ativação deste mecanismo permite recolher aproximadamente 4,0 L, 70 % da capacidade do saco do pó de papel. (aprox. 3,0 L [50 %] quando não ativado).



Este mecanismo pode ser acionado:

- Automaticamente pela vibração causada ao caminhar.
- Manualmente, acionando uma alavanca lateral.

**Comando controlador**



DVC660 / DVC661

DVC660 / DVC661

**Tecnologia de ligação sem fios**



A função de ativação sem fios automática permite um funcionamento limpo e prático. Ao ligar a ferramenta compatível com o aspirador, pode acionar o aspirador juntamente com o arranque da máquina.



O AWS está ligado à ferramenta elétrica através de Bluetooth.

A marca e os logótipos Bluetooth® são marcas comerciais registadas da propriedade da Bluetooth SIG, Inc. e qualquer uso de tais marcas pela Makita é realizado sob licença. Outras marcas e nomes comerciais são propriedade dos seus respetivos proprietários.

**O ar de saída é tão limpo como o do filtro do ar.**

O filtro HEPA é usado como filtro principal para capturar partículas muito finas de uma forma eficaz.



**O eficiente sistema de filtragem HEPA de três estágios captura 99,97 % das partículas com 3 micrones ou mais.**



DVC660 / DVC665



DVC261 / DVC265



## Acessórios para aspiradores

Bocal 28mm

Bocal 38mm

Bocal 32mm

### Para recolha do pó

\*Apenas para modelos DVC261, DVC265, DVC660, DVC665

<b>Modelo</b> VC006GM VC007GL	<b>Modelo</b> VC004GL DVC157L	<b>Modelo</b> DVC265 DVC665 DVC350	<b>Modelo</b> DVC750L	<b>Modelo</b> VC4210L/M VC3012L	<b>Modelo</b> VC2012L VC2512L VC3011L
<b>Tubo flexível 28mm</b> 1,0m *143787-2 sem adaptador 1,5m A-34235 com adaptador de 22, 38mm 2,5m 195437-5 com adaptador de 22, 24, 38mm 3,5m 195433-3 com adaptador de 22, 24, 38mm 5,0m 195436-7 com adaptador de 22, 24, 38mm		<b>Tubo flexível 38mm</b> Com adaptador de 38mm 1,5 M 198757-6 2,5 M 195434-1 5,0 M 195435-9		<b>Tubo flexível 32mm</b> 4m P-84084	<b>Tubo flexível 32mm</b> 3,5m P-81739
<b>Adaptadores</b> Adaptador 38mm 195545-2 Adaptador 22mm 195547-8		<b>Adaptador</b> Adaptador de mangueira 22-38mm 195548-6 <b>Adaptador</b> Adaptador 24mm 195546-0		<b>Adaptador</b> Adaptador de mangueira Kit 24mm P-70378 Kit 38mm W107418688	<b>Adaptador</b> 22mm W107418661 Adaptador 38mm W107418680

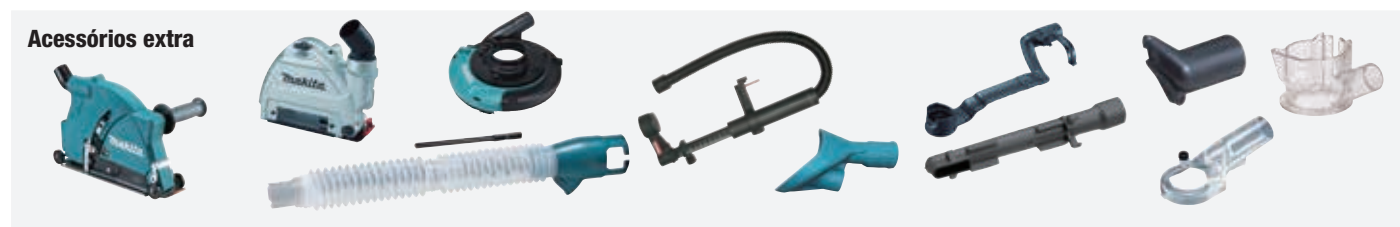

**AWS**  
Sistema de arranque sem fios

**Dispositivo AWS**

**WUT02**  
O adaptador converte os aspiradores activados por gatilho em aspiradores sem fio compatíveis com AWS.

199773-1

## Adaptadores e tubos flexíveis

<b>Tubo flexível 28mm</b> Fornecido com adaptadores para 22 e 38mm	<b>Bocal traseiro</b> Adaptador: 38mm Ø interior: 38mm Ø exterior: 44,2mm Adaptador: 22mm Ø interior: 22,4mm Ø exterior: 25mm	<b>Adaptadores 38, 22 e 24mm</b> Bocal de 28mm com adaptador de 22mm Bocal de 28mm com adaptador de 38mm Bocal de 38mm com adaptador de 38mm Bocal de 24mm
<b>Tubo flexível 38mm</b> Fornecido com adaptadores para 38mm	<b>Bocal traseiro</b> Adaptador: 38mm Ø interior: 38mm Ø exterior: 44,2mm	<b>Adaptador de mangueira 22-38</b> Bocal de 38mm Tamanho Ø interior: 22,4mm Ø exterior: 25mm Adaptador de mangueira 22-38
<b>Ligação entre tubos</b> Bocal de 28mm com adaptador de 38mm → Bocal de 28mm Bocal 38mm com adaptador de 38mm → Bocal de 38mm Bocais traseiros		

**Acessórios para aspiradores**

**A**



**Com bocal de 28mm**  
**Modelo** DVC157L  
 VC004GL DVC660 / DVC665  
 VC008G DVC261 / DVC265

**Com adaptador**  
 38mm 24mm 22mm



**B**



**Com bocal de 38mm**  
**Modelo**  
 VC003GL  
 VC005GL / DVC155L  
 DVC860L  
 DVC750L

**Com adaptador 22-38**



**C**



**Com bocal de 32mm**  
**Modelo**  
 VC2012L / VC2512L  
 VC3011L

**Com adaptador 24mm** **Adaptador 38mm (opcional)**



P-81745 P-70421

**D**



**Com bocal de 32mm**  
**Modelo**  
 VC3012L

**Com adaptador 24mm** **Com adaptador 38mm**



P-70378 W107418688



**A B**  
 Adaptadores de 24 ou 38mm

**C D**  
 Adaptador de 24mm



**A B**  
 Adaptador de 22mm

**C D**  
 Adaptador de 24mm

\*Base de apoio para a ventosa necessária.

	Modelo	Modo	Acs. de aspiração		Adaptador
			Tipo	Código	
Martelo demolidor	HM1501, HM1511, HM1512	---	Com bocal	191M20-4	Adaptadores de 24 ou 38mm
	HM1307C, HM1317C/CB, HM1812	---	Sem bocal	197168-2	Bocal de 28mm sem adaptador
	HM001G, HM002G, HM0830, HM0870C, HM0871C, HM1101C, HM1111C, HM1203C, HM1205C, HM1213C, HM1214C	---	Sem bocal	199143-4	Bocal de 28mm sem adaptador
Martelo combinado	HR5212C, HR5202C	Percussão / demolição	---	196858-4	Adaptadores de 22mm
	HR4002, HR4501C, HR4511C	Percussão / demolição	---	196074-8	Bocal de 28mm sem adaptador
	HR5212C, HR5202C, HR4002, HR4501C, HR4511C, HR4041C, HR4013C, HR4003C, DHR400, HR005G, HR006G	Demolição	---	199143-4	Bocal de 28mm sem adaptador

	Modelo	Modo	Acs. de aspiração		Adaptador
			Tipo	Código	
Martelo combinado	HR140D, HR166D, DHR165, DHR171, DHR182, DHR202, DHR263, DHR264, HR2230, HR2470, HR2470F, HR2470FT, HR2800, HR2810, HR2810T, HR2811FT	Percussão	Kit de recolha do pó	193472-7	Adaptador de 22mm
	*DHR165, *DHR171, *DHR182, *DHR202, DHR263, *HR1841F, *HR2230, HR2470, HR2470F, HR2800, HR2810	Todos	Coletor do pó	198362-9	Adaptador de 22mm
	DHR242, DHR280, DHR282, HR001G, HR003G, HR2300, HR2600, HR2630, HR2631F, HR2641, HR2651, HR2652, HR2653, HR3011F, HR007G	Todos	Coletor do pó	195173-3	Adaptador de 22mm
	DHR243, DHR281, DHR283, HR002G, HR2630T, HR2631FT, HR2653T, HR3012F	Todos	Coletor do pó	195179-1	Adaptador de 22mm



## Acessórios para aspiradores

### Serras circulares



\*Não necessita de outro adaptador



**A B**

Adaptadores de 22 ou 38mm



**C D**

Adaptador de 24mm



+ Ligação 25-50mm 192349-3



ou Adaptador de 24mm\*



Modelo	Conjunto de bocais e ligações		Adaptador
	Descrição	Código	
HS012G, DHS680	Conjunto de bocais	196961-1	Adaptador de 24mm
DHS710	Conjunto de bocais	196520-1	Adaptador de 24mm
DHS782, DHS783	Conjunto de bocais	196520-1	Adaptador de 24mm
HS009G, HS011G	---	---	Adaptador de 24mm
DHS900, DHS901, DSP600, DSP601	---	---	Adaptador de 24mm
RS001G	---	---	Adaptador de 24mm
RS002G	---	---	Adaptador de 38mm
5103R	Ligação e conjunto de ligações. Sem necessidade de parafuso	456914-5 / 192419-8	Adaptador de 38mm
5903R	Conjunto de ligações	192419-8	Adaptador de 38mm
HS004G	Conjunto de bocais	196520-1	Adaptador de 24mm
HS6601	Conjunto de bocais	196520-1	Adaptador de 24mm
HS7010	Conjunto de bocais	196520-1	Adaptador de 24mm
HS7601, HS7611	Conjunto de bocais	196520-1	Adaptador de 24mm
SP6000, SP001G	---	---	Adaptador de 24mm

### Colectores do pó para rebarbadoras



**A B**

Adaptadores de 22 ou 38mm



**C D**

Adaptador de 24mm



Modelo	Conjunto de colectores do pó		Adaptador
	Tipo de protecção	Código	
Modelos de entalhe triplo 125mm	C	196845-3	Adaptador de 38mm
Modelos de troca Sem fixação (alavanca)	C	191G06-2	Adaptador de 38mm
Modelos entalhe triplo Sem travão 230mm	D	198440-5	Adaptador de 38mm
Modelos de um e dois entalhes 230mm	B	198440-5	Adaptador de 38mm
Modelos de um entalhe 230mm	B	198440-5	Adaptador de 38mm



### Colectores do pó de discos de diamante



Modelo	Conjunto de colectores do pó para discos de diamante		Adaptador
	Tamanho	Código	
Modelos de entalhe triplo 180mm / 230mm	180mm	195385-8	Adaptador de 38mm
115-125mm	125mm	195239-9	Adaptador de 38mm
X-Lock 115-125mm	125mm	191F81-2	Adaptador de 38mm

**Acessórios para aspiradores**

**Modelo + Acessório** → **Aspirador + Acessório**

<b>Lixadora de fita</b> DBS180, 9032	<b>Bocal de aspiração</b> 122652-8	
<b>Lixadora de fita</b> 9031		
<b>Lixadora orbital</b> DB0380, DB0381, DB0382, DB0480, DB0481, DB0482, DB0484, 9046, B03711, B04900/V, B04901 B04556, B04565, B04566		
<b>Lixadora rotorbital</b> B05030, B05031, B05040, B05041, B06030, B06040, DB0180		
<b>Multifunções</b> DTM52 DTM51 TM3000C TM3010C	<b>Kit de aspiração</b> 191R02-6 199627-2 199618-3 199624-8	
<b>Lixadora de fita</b> 9404, 9903, 9910, 9911, 9920		
<b>Lixadora rotorbital</b> B06050J	<b>Adaptador 24mm</b> 195546-0	
<b>Lixadora de parede</b> DSL801	<b>Adaptador 24mm</b> 195546-0	

- A** Adaptador de 22mm
- B** Com adaptador 22-38mm  
195548-6
- C** Adaptador de 24mm  
+  
Ligação 25-50mm  
192349-3  
ou  
Adaptador de 24mm\*
- D** Adaptador de 38mm  
+  
Ligação 22+38mm  
195548-6  
ou  
Adaptador de 24mm\*

\*Não é necessário outro adaptador.



**Modelo + Acessório** → **Aspirador + Acessório**



























<b>Serra tico-tico</b> JV183D, 4326, 4327, 4328, 4329 JV0600		
<b>Serra tico-tico</b> DJV180, 4350T/CT/FCT, 4351CT	<b>Adaptador de aspiração</b> 417853-4	
<b>Serra tico-tico</b> DJV181, DJV182 JV102D, JV103D	<b>Kit de aspiração</b> 126331-0 457801-1	
	<b>Adaptador 24mm</b> 195546-0	

- A** Adaptador de 22mm
- B** Com adaptador 22-38mm  
195548-6
- C** Adaptador de 24mm  
+  
Ligação 25-50mm  
192349-3  
ou  
Adaptador de 24mm\*
- D** Adaptador de 38mm  
+  
Ligação 22+38mm  
195548-6  
ou  
Adaptador de 24mm\*

\*Não é necessário outro adaptador.



**Acessórios para aspiradores**

Modelo + Acessório	Aspirador + Acessório	Modelo + Acessório	Aspirador + Acessório
<b>Cortador de diamante</b> 4114S 	<b>Adaptador</b> 192613-2 	<b>Serra de esquadria</b> DLS714 	
<b>Cortador de diamante</b> 4100KB 		<b>Serra de esquadria</b> LS0714/F/FL, LS0815FL, LS1018/L 	
<b>Cortador de diamante</b> DCC500 		<b>Serra de esquadria</b> LS1030N, LS1440 	
<b>Roçadora</b> SG1251J 		<b>Serra de esquadria</b> LS1040/F 	<b>A</b> Adaptador de 38mm* 
<b>Desbastadora de diamante</b> PC5001C, PC5010C 		<b>Serra de esquadria</b> DLS600Z 	<b>B</b> 
<b>Lixadora de fita</b> 9924DB 	<b>Adaptador 32mm</b> 192518-6 	<b>Serra reversível</b> LF1000 	<b>C</b> Adaptador de 38mm 
<b>Lixadora de fita</b> 9403 	<b>Adaptador 24mm</b> 195546-0 	<b>Serra de esquadria com mesa</b> LH1040/F, LH1201FL 	<b>D</b> Adaptador de mangueira 38mm 
<b>Lixadora</b> N9741 	<b>Adaptador</b> 410899-9 	<b>Serra de esquadria</b> LS1019/L, LS1219/L 	
		<b>Adaptador 24mm</b> 195546-0 	
		<b>Serra de esquadria</b> LS002G, LS003G, LS004G, DLS111, DLS211 	

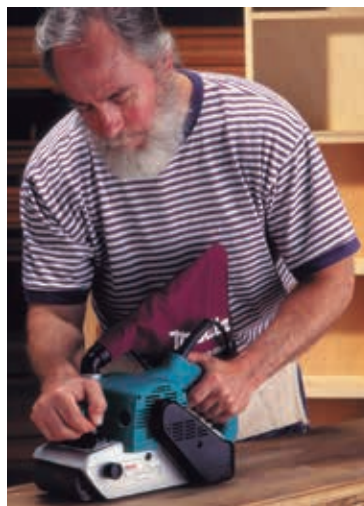

**Acessórios para aspiradores**

**Modelo + Acessório** → **Aspirador + Acessório**

**Serra de mesa**  
MLT100N

**Adaptador de aspiração**  
JM27000090



**Serra de mesa**  
2712



**Plaina desengrossadeira**  
2012NB

**Adaptador de aspiração**  
193036-7



**A** Adaptador de 38mm\*



\* Exceto modelos:  
VC008G / DVC660 /  
DVC665 / DVC261 /  
DVC265

**B**



**C** Adaptador de 38mm



**D** Adaptador de mangueira 38mm



Válido apenas para tomada industrial.  
Diâmetro exterior: 75 mm



**Modelo + Acessório** → **Aspirador + Acessório**

**Plaina**  
KP001G, DKP181,  
KP0810/C



**Plaina**  
DKP180, KP0800

**Bocal**  
451329-1



**Plaina**  
1100

**Saída de aparas**  
415452-6



**Plaina**  
KP0800, KP312/S



**A** Adaptador de 38mm\*



\* DV350: Não pode ser utilizado com plainas

**B**



**C** Adaptador de 38mm



**D** Adaptador de mangueira 38mm



**Adaptador de bocais**



**Ligação**  
\*Cotovelo



Modelo	Código
1923B	152464-5
KP0800, DKP180	451329-1
KP312/S	193733-5

Modelo	Código
DKP180, DKP181, KP0810/ C, KP0800	*191C20-4
1804N, 1805N, 1806B, KP312/S	181575-9



**Acessórios para aspiradores**

Modelo + Acessório

Aspirador + Acessório

Modelo + Acessório

Aspirador + Acessório

**Lameladora**  
PJ7000, DPJ180



**Fresadora de corte** 3706 **Coletor do pó** 193449-2



**Fresadora de corte**  
DC0181, DC0180



**Cortador de gesso cartonado**  
DSD180, SD100D



**Fresadora**  
RP1111C, RP1110C,  
RP0910



**A** Adaptador de 22mm



\*DVC350  
No puede usarse  
Com fresadoras

**B** Com adaptador 22-38mm



195548-6

**C** Adaptador de 24mm



+  
Ligação 25-50mm  
192349-3



**D** Adaptador de 38mm



+  
Ligação 22+38mm  
195548-6



**Fresadoras**  
RP1802/F, RP1801F,  
RP1800/F, RP2303FC,  
RP2300FC



3612BR

**Bocal de aspiração**  
194934-8



192035-6

**Fresadoras**  
RP0900, RT0700C,  
RT0702C



**Bocal de aspiração**  
194733-8



**Fresadoras**  
RT001G, DRT50

**Fresadora multifunções**  
RT0700C,  
RT001G,  
DRT50



**Adaptador de aspiração**  
195559-1



**A** Adaptador de 38mm



**B**



**C** Adaptador de 38mm



**D** Adaptador de mangueira 38mm





**Acessórios para aspiradores**

Com bocal

Acessórios de 28mm

**Para limpeza**

\*Apenas para modelos DVC261, DVC265, DVC660, DVC665

**Modelo**

VC006GM VC005GL  
VC007GL DVC155L  
VC003GL DVC860L



**Modelo**

DVC261  
DVC660



**Tubo flexível 38mm**

Com bocal 32A

1,5m 199388-4



**Tubo flexível 32mm**

Com bocal 32A

1,5m 199463-9  
1,7m 199493-7



**Tubo flexível 28mm**

1,0m \*143787-2  
1,5m 152992-0  
2,5m 195437-5  
3,5m 195433-3  
5,0m 195436-7



**Tubo curvo com fecho**

28mm Com bocal 32A

140G26-3



**Tubo curvo com fecho 28mm + jack**

127093-3



**Tubo curvo com fecho 28mm + jack**

458184-2



**Tubo curvo sem fecho 28mm + jack**

126756-8



**Adaptador de 22mm**

126756-8



**Acessório ciclónico com fecho**

191D71-3 ○



**Acessório ciclónico sem fecho**

199491-1



**Tubo telescópico com fecho 28mm alumínio**

590-942mm  
140G19-0



**Tubo telescópico com fecho 28mm plástico**

590-950mm  
127605-2



**Tubo reto com fecho 28mm plástico 479mm**

459353-8 ○  
459356-2 ●



**Tubo reto com fecho 28mm plástico 340mm**

191D76-3 ○



**Tubo telescópico sem fecho 28mm plástico 500-850mm**

198560-5



**Tubo reto sem fecho 28mm plástico 465mm**

451424-7 ●  
451241-5 ○  
451244-9 ●  
456587-4 ●

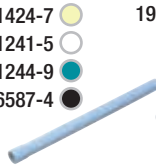

**Tubo reto sem fecho 28mm plástico 320mm**

191D79-7 ○



**Bocal extra largo**

192236-6\*



\* usar com J22 195547-8

**Acessórios de 28mm**

**Pé de aspiração**

Plano

199454-7 ●



**Pé de aspiração**

Universal

123488-8 ●  
123539-7 ●



**Pé de aspiração**

Alcatifa

198149-9 ●  
198527-3 ●  
198529-9 ●



**Pé de aspiração**

Alcatifa

122291-4 ●



**Escova larga**

Banco automóvel

199041-2 ●



**Escova**

Tapetes automóvel

459056-4 ●



**Escova curta**

Banco automóvel

140H95-0 ●



**Escova reta**

191M30-1 ●



**Ranhas curto**

416041-0 ●  
413859-0 ●  
456586-6 ●



**Ranhas largo**

198990-0 ●  
198992-6 ●



**Ranhas largo**

199439-3 ○



**Escova redonda**

198552-4 ●  
198553-2 ●  
198555-8 ●



**Escova reta**

198537-0 ●  
198538-8 ●  
198540-1 ●



**Boquilha rotativa**

140H94-2 ●



**Bocal de borracha para ranhas**

422437-5



**Bocal flexível**

197901-2



Estes bocais não podem ser ligados diretamente a tubos retos ou telescópicos.

**Acessórios para aspiradores**

Acessório 38mm

Conexion 32mm

Acessório 28mm

**Modelo**  
VC003GL  
VC005GL  
DVC155L  
DVC860L



**Modelo**  
VC008G  
DVC261  
DVC660  
DVC350



**Kit completo**

Tubo flexível 38mm x 2,5m  
Tubo reto e curvo  
Pé de aspiração  
Bocal de ranhuras  
195439-1



**Tubo flexível 38mm**

1,5 198757-6  
2,5 195434-1  
5,0 195435-9



**Tubo curvo**

192562-3



**Tubo reto**

192563-1



**Pé de aspiração**

Plano / Seco  
199454-7



**Pé de aspiração**

Universal  
195551-7



**Pé de aspiração**

Húmido  
A-47846



**Pé de aspiração**

Chão e alcatifa / Seco  
198533-8



**Pé de aspiração**

Compacto tipo A Seco  
122335-2



**Escova redonda**

191657-9



**Pé de aspiração**

Compacto tipo B húmido  
122335-0



**Bocal ranhuras**

410306-2



**Modelo**  
VC4210L  
VC4210M



**Modelo**  
VC2012L  
VC2512L  
VC3011L



**Modelo**  
DCL184, CL121D



**Tubo flexível**  
32mm  
4m P-84084



**Tubo flexível**  
32mm  
3,5m P-81739



**Tubo curvo inox.**  
P-70346



**Tubo curvo**  
P-72908



**Tubos retos**  
35 x 500mm  
(2 unds)  
P-70437



**Tubos retos**  
35 x 520mm  
(2 unds)  
P-72942



**Tubos retos**  
35 x 350mm  
(3 unds)  
W107418350



**Pé seco / húmido**  
36 x 300mm  
P-81789



**Pé seco / húmido**  
36 x 260mm  
W107402706



**Bocal para ranhuras**  
5 x 300mm  
W6084



28 mm



**Bocal flexível**  
197901-2



**Bocal de sopro para automóvel completo**  
140J64-3



**Filtro e saco do pó**



**Para poeiras (partículas)**

Filtro de partículas

Amortecimento

Pré-filtro

Saco de recolha do pó (plástico ou tecido)

**Para húmido e seco**

Filtro de tecido ou filtro para água

**Compatível com sacos de plástico e de tecido de uso comum, conseguindo:**

- Fácil extracção e esvaziamento do pó
- Custo reduzido e maior durabilidade em comparação com os sacos de papel



	VC006GM, VC007GL (húmido e seco)	VC003GL (húmido e seco)	VC004GL, VC005GL (seco)	DVC155L, DVC860L (húmido e seco)  DVC157L, DVC861L (seco)	
Utilizado como um kit	<b>Kit de filtro para partículas do pó</b> Apenas para seco.  *Filtro HEPA para uso em seco.	1911B6-0 *1911B7-8	*191V70-3	*191V70-3	*1917166-6
	<b>Kit de amortecimento</b>	1911B4-4	191V68-0	191V68-0	195552-5
	<b>Kit de pré-filtro</b>	1911B5-2	191V69-8	191V69-8	195553-3
<b>Filtro de tecido</b> Para húmido e seco.		144625-1	144625-1 191V71-1 *só para VC005G	140248-3	
<b>Filtro para água</b> Para húmido. Recomendado para recolher repetidamente grandes quantidades de água.	1910N0-0	191V67-2			
<b>Kit de Sacos de filtros de nylon</b> 10L/15L/25L/35L (5 und.) Para seco.	35L: 1910Y4-9	10L: 1912R3-4 VC005GL, DVC860 15L: 1912R3-4 VC003GL, VC004GL, DVC155L, DVC157L			
<b>Kit de Sacos de filtros de plástico</b> (10 unidades)	1910R3-2	195432-5	195432-5	195432-5	

Para utilizar um filtro do pó, retire o flutuador da caixa, removendo as patilhas laterais.

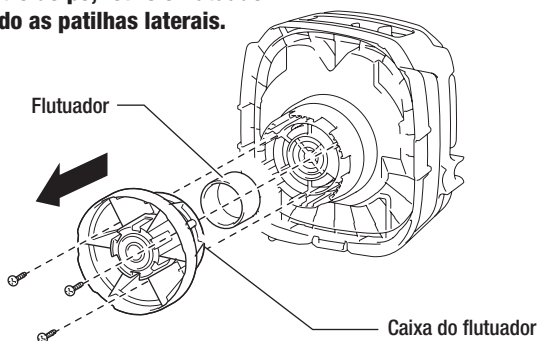

## Acessórios para aspiradores de mão

### Modelos com fecho:

- CL001G ● ● ○
- CL002G ● ● ○
- CL003G ● ● ○
- DCL281F ● ● ○
- CL117FD ● ○



### Modelos sem fecho:

- DCL180 ● ●
- CL106D ● ○
- CL108FD ● ○
- CL100D ● ○



### Acessório ciclónico com fecho

191D71-3 ○



### Acessório ciclónico com fecho

1910D5-0\* ●

\* Só para modelos CL001G, CL003G, DCL284F, DCL286F, DCL180



### Acessório ciclónico sem fecho

199491-1\*



\* Sensor incluído

### Mangueira flexível

191E30-3



### Tubo reto com fecho

#### Tubo reto 28L telescópico de plástico com fecho

479-719mm  
Compatível com: CL001G, CL002G, CL003G, DCL284F, DCL286F, DCL281F, 1910Y3-1 ○



#### Tubo reto 28L de plástico com fecho

479mm  
459353-8 ○  
459356-2 ●



#### Tubo reto 28L de plástico com fecho

340mm  
Para acessórios ciclónicos  
191D76-3 ○



### Tubo telescópico sem fecho

28mm plástico 500-850mm

198560-5



#### Tubo reto sem fecho 28mm plástico 465mm

451424-7 ●  
451241-5 ○  
451244-9 ●  
456587-4 ●

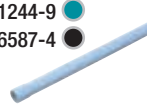

#### Tubo reto sem fecho 28mm plástico 320mm

191D79-7 ○



### Tubo flexível

198544-3 ○  
198545-1 ●  
198547-7 ●



### Acessórios de 28mm

#### Pé de aspiração

Plano  
199454-7 ●



#### Pé de aspiração

Universal  
123488-8 ●  
123539-7 ●



#### Pé de aspiração

Alcatifa  
198149-9 ●  
198527-3 ●  
198529-9 ●



#### Ranuras curto

416041-0 ●  
413859-0 ●  
456586-6 ●



#### Ranuras largo

198990-0 ●  
198992-6 ●



#### Ranuras extra-largo

199439-3 ○



#### Pé de aspiração

Alcatifa  
122291-4 ●



#### Escova larga

Banco automóvel  
199041-2 ●



#### Escova

Tapetes automóvel  
459056-4 ●



#### Escova curta

Banco automóvel  
140H95-0 ●



#### Escova reta

191M30-1 ●



### Bocal de borracha para ranhuras

422437-5



Este bocal não pode ser ligado directamente a tubos retos ou telescópicos.

### Escova redonda

198552-4 ●  
198553-2 ●  
198555-8 ●



### Escova reta

198537-0 ●  
198538-8 ●  
198540-1 ●



### Boquilha rotativa

140H94-2 ●



### Suporte de parede

Compatível com:  
CL001G, CL002G, DCL284F, DCL281F  
DCL180, DCL180F  
199971-7

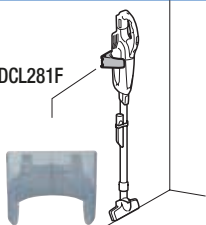

## Acessórios para aspiradores de mão

Aspirador tipo cápsula Modelos: CL001G, DCL284F, DCL281F, DCL180F, CL108FD, CL106FD, CL070D

**Filtro HEPA**  
199989-8  
**HEPA filter**  
Exceto modelo: CL183D

**Filtro HEPA + Pré-filtro**

**Filtro HEPA + Filtro do pó**

**Pré-filtro**  
198751-8

**Estrutura do filtro**  
458467-0

**Filtro (10 und)**  
198915-4

**Filtro do pó**

**Filtro do pó (de alta eficiência)**  
199966-0

**Válvula**  
424208-6

**Esponja 57**  
422268-2  
Exceto modelo: CL070D, CL183D



Aspirador de saco de papel Modelos: CL001G, DCL284F, DCL281F, DCL180F, CL108FD, CL106FD, CL070D

**Aspiradores de mão**

**Esponja 76-110**  
424804-0

**Estrutura**  
413J77-0  
Só para CL002G

**Saco de papel (10 und)**  
(de alta eficiência)  
198745-3

**Válvula anti-pó**  
143677-9  
Para DCL184, CL121D

**140K23-3**  
CL002G

**Saco para pó**  
198747-9

**DCL184, CL121D**

**Esponja 90**  
422440-6

**Saco para pó fácil de esvaziar**  
198749-5  
Só para CL002G

**Saco para pó alta eficiência**  
1910M4-5  
Só para CL002G

Novo acessório ciclônico Modelos: CL001G, CL003G, DCL284F, DCL286F, DCL180

**Acessório ciclônico com fecho**  
1910D5-0\*

**Esponja 62**  
(equipamento básico)  
422909-0

**Filtro HEPA** **HEPA filter**  
1910C9-5

**Filtro de alta eficiência**  
(equipamento básico)  
1910C7-9

**Esponja de filtro**  
(equipamento básico)  
422908-2



**Acessórios para aspirador vertical e portátil**

Cor

**Aspirador vertical Modelo: DVC560**

Acessórios de 28mm

**Escova larga**  
Banco automóvel  
199041-2 ●



**Ranhuras largo**  
198990-0 ●  
198992-6 ●



**Escova**  
Tapetes automóvel  
459056-4 ●



**Ranhuras extra-largo**  
199439-3 ○



**Escova curta**  
Banco automóvel  
140H95-0 ●



**Escova redonda**  
198552-4 ●  
198553-2 ●  
198555-8 ●



**Escova reta**  
191M30-1 ●



**Escova reta**  
198537-0 ●  
198538-8 ●  
198540-1 ●



**Boquilha rotativa**  
140H94-2 ●



**Kit de sacos (10 und)**  
191T96-3



**Filtro HEPA**  
191E39-5

**HEPA filter**



**Kit completo de escovas**



**Aspirador/Soprador portátil Modelo: DVC750**

**Tubo flexível para limpeza**  
28-2,0m com adaptador de 38mm  
140G04-3



**Para seco**

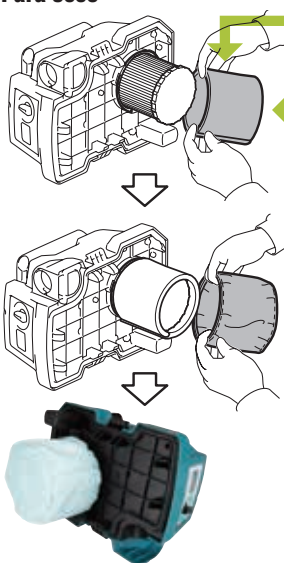

**Filtro HEPA**  
Para seco 162518-0



**Filtro de esponja**  
422449-8



**Pré-filtro**  
162635-6



Acessórios de 38mm

**Bocal largo**  
458891-7



**Escova redonda**  
191657-9



**Adaptador 38mm**  
418500-0



**Bocal curto**  
458919-1



**Bocal ranhuras**  
410306-2



**Adaptador 22-38mm**  
195548-6

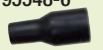

**Bocal extra-largo**  
192236-6\*



**Acessórios de 28mm**



**Suporte de ombro**  
199486-4



## Acessórios para aspiradores de mochila e robots aspiradores

Aspiradores de mochila Modelos: VC008G, DVC660, DVC665, DVC261, DVC265

DVC660, DVC665



**Saco reutilizável**  
191C30-1

**Kit de sacos de nylon com filtro (10 und)**  
191C26-2

**Filtro HEPA**  
191D12-9  
**HEPA filter**

VC008G, DVC261, DVC265



**Saco reutilizável**  
197899-3

**Kit de sacos de nylon com filtro (10 und)**  
197899-3

**Filtro HEPA**  
191Y27-2 (VC008G)  
127725-2 (DVC261, DVC265)  
**HEPA filter**

Robots aspiradores Modelos: DRC200 e DRC300

DRC200

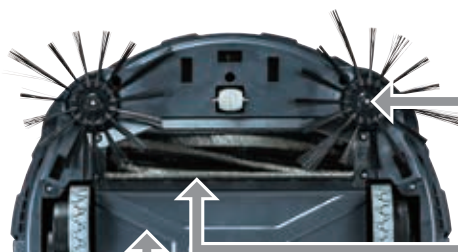

**Fita de marcação 15 m**  
SH00000231

**Filtro do pó**  
SH00000314

**Escovas laterais (2 und)**  
SH00000065

**Escova coletora**  
SH00000313

**Filtro do pó**  
SH00000213

DRC300



**Fita magnética de 5m**  
191P18-9  
Com fita adesiva de dupla face

**Filtro do pó**  
191P24-4

**Escovas laterais (2 und)**  
191P26-0 suave  
191P28-6 duro

**Escova coletora**  
191P20-2 suave  
191P22-8 duro

suave

duro

**Filtro HEPA**  
191P31-7  
**HEPA filter**

**Almofada de proteção**  
191X35-7  
Almofada a colocar à volta do aspirador para absorver os choques com objectos





Código	EAN	P.V.P (€)
A-34235	0088381163293	37,00
122291-4	0088381118668	16,00
122335-0	0088381126878	15,40
122335-2	-	*
122652-8	0088381164030	2,50
123488-8	0088381589765	11,00
123539-7	0088381592987	11,00
126331-0	0088381445740	3,50
126756-8	0088381548403	9,00
127093-3	0088381541619	11,60
127605-2	-	31,50
<b>R</b> 127725-2	0088381575621	10,00
140G04-3	-	8,25
140G19-0	0088381541626	22,00
140G26-3	0088381584180	9,80
140H94-2	0088381544917	4,00
140H95-0	0088381544887	5,50
140J64-3	0088381544924	8,10
<b>R</b> 140K23-3	-	2,00
<b>R</b> 143677-9	0088381526494	1,70
143787-2	0088381485838	32,00
152464-5	3240890072856	4,50
152992-0	0088381539135	32,50
<b>R</b> 162518-0	0088381547864	20,10
162635-6	-	10,50
181575-9	0088381123129	8,60
1910C7-9	-	16,00
1910C9-5	-	18,00
1910D5-0	-	*
<b>R</b> 1910M4-5	-	6,10
1910N0-0	-	22,25
1910R3-2	-	15,50
1910Y3-1	-	13,50
1910Y4-9	-	33,25

Código	EAN	P.V.P (€)
1911B5-2	-	13,50
1911B6-0	-	25,00
1911B7-8	-	28,00
1912R3-4	-	27,00
191657-9	0088381142892	15,40
191C20-4	0088381557443	6,00
191C26-2	0088381557702	23,00
191C30-1	0088381557696	20,00
<b>R</b> 191D12-9	0088381557719	12,30
191D71-3	0088381556637	42,00
191D76-3	0088381556668	6,40
191D79-7	0088381556699	4,70
191E30-3	-	*
191E39-5	0088381565431	11,70
191F81-2	0088381565479	52,00
191G06-2	0088381566001	87,00
191M20-4	0088381575713	67,00
191M30-1	0088381572002	11,60
191P18-9	-	40,00
<b>R</b> 191P20-2	-	47,25
<b>R</b> 191P22-8	-	43,05
<b>R</b> 191P24-4	-	31,50
<b>R</b> 191P26-0	-	18,70
<b>R</b> 191P28-6	-	16,80
<b>R</b> 191P31-7	-	12,00
191R02-6	0088381580564	12,00
191T96-3	-	21,00
191V67-2	0088381586023	24,00
191V68-0	0088381586030	9,90
191V69-8	0088381586047	43,00
191V70-3	0088381586054	30,00
191X35-7	0088381587846	14,40
<b>R</b> 191Y27-2	-	16,05
192035-6	0088381101561	20,00

Código	EAN	P.V.P (€)
192236-6	0088381117746	6,00
192349-3	0088381126229	8,20
192419-8	0088381158640	3,50
192518-6	0088381132237	14,50
192562-3	0088381141116	9,70
192563-1	0088381141123	9,30
192613-2	0088381140843	15,40
193036-7	0088381154390	29,00
193449-2	0088381160490	7,20
193472-7	0088381174022	49,00
193733-5	0088381182492	31,50
198440-5	0088381194648	146,00
198745-3	0088381351270	4,40
194733-8	0088381358972	3,00
194934-8	0088381356756	11,60
195173-3	0088381361125	7,50
195179-1	0088381361194	9,00
195239-9	0088381361804	52,00
195385-8	0088381369381	71,00
195432-5	0088381369473	7,50
195433-3	0088381370264	63,00
195434-1	0088381370271	63,00
195435-9	0088381370288	117,00
195436-7	0088381370295	77,00
195437-5	0088381370301	50,00
195439-1	0088381370493	107,00
195545-2	0088381370325	7,20
195546-0	0088381370332	4,50
195547-8	0088381370349	3,40
195548-6	0088381370356	8,80
195551-7	0088381370394	29,00
195552-5	-	*
195553-3	-	*
1912R3-4	0088381370479	27,00





Código	EAN	P.V.P (€)
195559-1	0088381411295	3,60
196074-8	0088381407632	112,00
196520-1	0088381538701	5,50
196845-3	0088381442527	81,00
196858-4	0088381441599	82,00
196961-1	0088381488891	2,00
<b>R</b> 197166-6	0088381449953	66,15
197168-2	0088381449984	57,00
197899-3	0088381468060	28,00
197901-2	0088381468084	7,00
198149-9	0088381475020	15,40
198362-9	0088381483636	11,80
198440-5	0088381487368	146,00
198527-3	0088381484299	15,40
198529-9	0088381484312	15,40
198533-8	0088381484336	26,00
198537-0	0088381484374	7,70
198538-8	0088381484381	5,80
198540-1	0088381484404	5,80
198544-3	0088381484442	8,80
198545-1	0088381484459	8,80
198547-7	0088381484473	8,80
198552-4	0088381484527	5,80
198553-2	0088381484534	5,80
198555-8	0088381484558	5,80
198560-5	0088381484589	25,00
198747-9	-	3,70
198749-5	-	7,50
198751-8	0088381490450	4,40
198757-6	0088381495899	61,00
198915-4	0088381497497	7,90
198990-0	0088381519335	2,35
198992-6	0088381519359	2,35
199041-2	0088381524995	7,70

Código	EAN	P.V.P (€)
199142-6	0088381524339	107,00
199143-4	0088381524346	20,00
199388-4	0088381533874	63,00
199439-3	0088381537162	4,10
199454-7	0088381539685	31,00
199486-4	-	*
199491-1	0088381536905	39,00
199493-7	0088381539142	20,00
199618-3	0088381545303	7,00
199624-8	0088381545297	8,80
199627-2	0088381545327	11,50
199773-1	0088381542807	248,00
<b>R</b> 199966-0	0088381546515	7,60
199971-7	0088381546171	5,60
199989-8	0088381546522	8,20
410306-2	0088381123709	3,60
410899-9	0088381155052	1,50
413J77-0	-	*
456914-5	0088381141352	5,50
415452-6	0088381142717	3,70
416041-0	0088381141284	1,50
417853-4	0088381170833	1,10
418500-0	0088381495509	3,05
<b>R</b> 422268-2	-	0,35
422437-5	0088381544900	8,50
<b>R</b> 422440-6	-	0,55
422449-8	-	2,95
422908-2	-	1,05
422909-0	-	0,30
<b>R</b> 424208-6	0088381588508	0,40
424804-0	-	*
451241-5	0088381362733	2,30
413859-0	0088381453769	1,50
451244-9	3240890273475	4,30

Código	EAN	P.V.P (€)
<b>R</b> 451329-1	0088381361422	1,60
451424-7	0088381366847	2,35
456586-6	-	1,00
456587-4	-	2,10
<b>R</b> 457801-1	-	4,75
458184-2	0088381536028	7,00
<b>R</b> 458467-0	-	0,60
458891-7	0088381559058	3,50
458919-1	8720023001014	1,75
459056-4	0088381544894	2,65
459353-8	-	2,45
459356-2	0088381556897	2,45
A-47846	0088381313360	34,00
JM27000090	3240890357519	0,80
P-70346	0088381700900	32,00
P-70378	0088381700931	25,00
P-70421	0088381700986	20,00
P-70437	0088381700993	45,00
P-72908	0088381703567	26,00
P-72942	0088381703604	30,00
P-81739	0088381457552	39,00
P-81745	0088381457569	22,00
P-81789	0088381457385	28,00
P-84084	0088381483896	70,00
<b>R</b> SH00000313	-	90,30
<b>R</b> SH00000314	-	44,10
<b>R</b> SH00000065	0088381479158	50,40
<b>R</b> SH00000213	0088381479189	89,25
<b>R</b> SH00000231	0088381475877	64,05
W107402706	-	15,40
W107418350	0088381490122	35,00
W107418688	0088381519946	30,00
W6084	0088381431095	5,50

**Acessórios de recolha de pó**

**Mangueira de 28mm**

Pág. 305 / 298



Comp. (m)	Tipo	Adaptador	Inclui	Unds.	Código	EAN	P.V.P. (€)
1	Mangueira antiestática	Sem adaptador	-	1	143787-2	0088381485838	32,00
1,5		Adaptador 38mm	-		152992-0	-	32,50
1,5		Adaptador 38mm	Adaptador 22mm		A-34235	0088381163293	37,00
2,5		Adaptador 22mm	Adaptador 38, 24mm		195437-5	0088381370301	50,00
3,5		Adaptador 38mm	Adaptador 22, 24mm		195433-3	0088381370264	63,00
5		Adaptador 38mm	Adaptador 22, 24mm		195436-7	0088381370295	77,00

**Mangueira de 38mm**

Pág. 305



Pág. 306 / 298



Comp. (m)	Tipo	Adaptador	Inclui	Unds.	Código	EAN	P.V.P. (€)
1,5	Mangueira antiestática	Adaptador 32A	Tubo curvo	1	199388-4	0088381533874	63,00
1,7	Mangueira antiestática	Adaptador 32A	Tubo curvo	1	199493-7	0088381539142	20,00

Comp. (m)	Tipo	Adaptador	Unds.	Código	EAN	P.V.P. (€)
1,0	Mangueira antiestática	Adaptador 32mm	1	199453-9	0088381539043	17,60
1,5	Mangueira antiestática	Adaptador 38mm	1	198757-6	0088381495899	61,00
2,5				195434-1	0088381370271	63,00
5				195435-9	0088381370288	117,00

**Mangueira tipo B de 32mm**



Pág. 298

Comp. (m)	Tamanho	Modelo	Unds.	Código	EAN	P.V.P. (€)
4	32B	VC3012L/M, VC4210L/M	1	P-84084	0088381483896	70,00
3,5		VC2012L, VC2512L, VC3011L		P-81739	0088381457552	39,00

**Adaptadores**



Tipo	Mangueira	Adaptador	Unds.	Código	EAN	P.V.P. (€)
Adaptador de 22mm	Mangueira de 28mm sem adaptador	22mm	1	195547-8	0088381370349	3,40
Adaptador de 38mm	Mangueira de 28mm sem adaptador	38mm		195545-2	0088381370325	7,20
Adaptador de 24mm	Mangueira com adaptador de 22 ou 38mm	24mm		195546-0	0088381370332	4,50
Adaptador de 25mm	Mangueira com adaptador de 24mm	25mm		192349-3	0088381126229	8,20
Adaptador de 18-21mm	Mangueira com adaptador de 22mm	Para tubos de 18-21mm		192202-3	-	-

**Acessórios de recolha de pó**

**Conexões**



Tipo	Adaptador	Unds.	Código	EAN	P.V.P (€)
C38	32x38mm	1	191M79-1	0088381575799	10,00
B35	32x35mm		191M78-3	0088381575782	10,00
A32	32x32mm		191M77-5	-	*

**Tubos curvos 28mm**



Mangueira e adaptadores Compatíveis	Tubo compatível	Unds.	Código	EAN	P.V.P (€)
Mangueira de 28mm sem adaptador	28L	1	127093-3	0088381541619	11,60
Adaptador 32A			140G26-3	0088381584180	9,80
Mangueira de 28mm sem adaptador	28		126756-8	0088381548403	9,00
Adaptador 32A			458184-2	0088381536028	-

**Tubo curvo inox. 32mm**



Modelo	Unds.	Código	EAN	P.V.P (€)
VC4210L/M	1	P-70346	0088381700900	32,00

**Kit completo**

Tubo flexível 38mm x 2,5m  
Tubo reto e curvo  
Pé de aspiração  
Bocal de ranhuras



Código	EAN	P.V.P (€)
195439-1	0088381370493	107,00

**Tubo de alumínio**

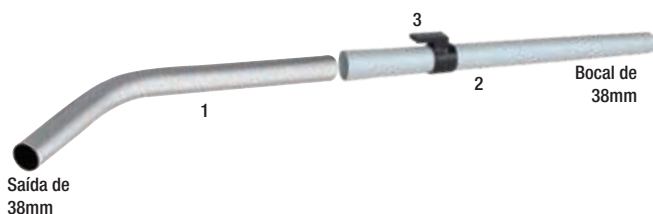

Saída de 38mm

Comp. (m)	Tipo	Material	Unds.	Código	EAN	P.V.P (€)
1	Tubo curvo	Alumínio	1	192562-3	0088381141116	9,70
2	Tubo reto	Alumínio		192563-1	0088381141123	9,30
3	Parafuso M4x20 + porca	-		911138-5	-	0,35

**Tubo de extensão inox. 32mm**



Modelo	Descrição	Unds.	Código	EAN	P.V.P (€)
VC4210L/M	ø35x350mm 3pcs	1	W107418350	0088381490122	35,00
VC2012L, VC2512L, VC3011L	ø35x350mm 2pcs negro		P-72942	0088381703604	30,00

**Acessórios para DCL501**



Modelo	Descrição	Unds.	Código	EAN	P.V.P (€)
Mangueira	-	1	SH00000034	-	84,00
Tubo reto	Comprimento ajustável		SH00000060	-	79,80
Escova para chão	Alcatifa e chão		SH00000058	-	26,00
Bocal para ranhuras	-		SH00000042	0088381467056	12,70

**Pés de aspiração 32**



Modelo	Tipo	Húmido/seco	Unds.	Código	EAN	P.V.P (€)
VC4210L/M	D36 x 300	Húmido/seco	1	P-81789	0088381457385	28,00
VC2012L, VC2512L, VC3011L	D36 x 260	Húmido/seco		W107402706	-	15,40
VC2012L, VC2512L, VC3011L	Tipo universal	Húmido/seco		W14295	4005337142955	4,40



**Acessórios de recolha de pó**

**Ligação com adaptador**

Tipo	Adaptador	Saída	Unds.	Código	EAN	P.V.P. (€)
 Adaptador de 24mm	Adaptador 22 e 38mm	Adaptador 24mm	1	195546-0	0088381370332	4,50
 Ligação de 22-38mm	Adaptador 38mm	Adaptador 22mm		195548-6	0088381370356	8,80
 Ligação de 38mm	Adaptador 38mm	Adaptador 28mm		418500-0	0088381495509	3,05
 Ligação estreita 38mm	Adaptador 38mm	Adaptador 38mm		415021-3	-	*
 Ligação de 70	Adaptador 38mm	Tubo 70mm		181575-9	0088381123129	8,60

**Escova para pára-brisas**



Modelo	Unds.	Código	EAN	P.V.P. (€)
DUB185, DUB186, UB100D, UB101D, UB1103	1	191M32-7	0088381572019	12,00

**Bocais de ranhuras 30**



Modelo	Descrição	Unds.	Código	EAN	P.V.P. (€)
VC4210L/M	ø35x300 mm	1	W6084	0088381431095	5,50
VC2012L, VC2512L, VC3011L	ø35x200 mm		W29541	3240890360908	4,70

**Bocal de aspiração e sopro**



Modelo	Tamanho (mm)	Unds.	Código	EAN	P.V.P. (€)
DUB182, DVC350	220	1	132025-7	0088381122856	4,10
	430		134182-7	0088381156998	11,10
UB100D, UB101D, DUB185, DUB186, UB1103	220		123245-4	0088381451215	5,80
	430		123246-2	0088381437332	13,50

**Adaptador de ferramentas**

Modelo	Descrição	Unds.	Código	EAN	P.V.P. (€)
VC2012L, VC2512L, VC3011L	Adaptador de 22mm de mudança rápida	1	W107418661	-	20,00
VC4210L/M	Adaptador para mangueira 24mm		P-70378	0088381700931	25,00
	Adaptador para mangueira 38mm		W107418688	0088381519946	30,00
VC2012L, VC2512L, VC3011	Adaptador para tubo com regulador de ar		P-81745	0088381457569	22,00
VC4210L/M, VC2012L, VC2512L, VC3011L	Ligação 25-50mm		192349-3	0088381126229	8,20
	Adaptador 35-38mm	P-70421	0088381700986	20,00	
VC4210L/M	Adaptador para tubo 24mm	P-70415	0088381700979	10,50	
	Adaptador para tubo 38mm	P-70421	0088381700986	20,00	

**Escova com pega**



Modelo	Unds.	Código	EAN	P.V.P. (€)
DUB185, DUB186, UB100D, UB101D, UB1103	1	191M30-1	0088381572002	11,60

**Bocal longo e curvo**



Modelo	Unds.	Código	EAN	P.V.P. (€)
UB100D, UB101D, DUB185, DUB186, UB1103		191G09-6	0088381561846	7,00

**Filtros e Sacos**

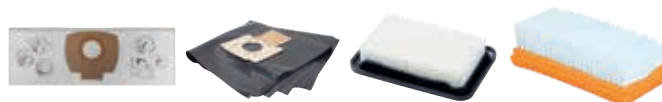

Modelo	Descrição	Unds.	Código	EAN	P.V.P. (€)
VC2012L, VC2512L, VC3011L	Saco de feltro	5	P-72899	0088381703550	28,00
	Saco de plástico		P-70297	0088381700856	38,00
VC4210L/M	Cartucho filtro nylon	1	W107418351	0088381490139	66,00
	Cartucho filtro lateral		W107418352	0088381490146	39,00
	Saco de papel	5	W107418353	0088381490153	39,00
	Saco de plástico		W107418355	0088381490177	35,00

**Acessórios para aspiradores**

**Bocal extra-longo**



\* usar com J22 195547-8

Modelo	Cor	Unds.	Código	EAN	P.V.P. (€)
DVC350, UB100D, UB101D, DUB185, DUB186	Cinzentos	1	192236-6	008838117746	6,00

**Depósito do pó**



Modelo	Unds.	Código	EAN	P.V.P. (€)
DUB185, DUB186, UB100D, UB101D, UB1103	1	123241-2	0088381437103	8,70
UB1100, UB1101		122321-1	-	3,50

**Tubo flexível**



Modelo	Unds.	Código	EAN	P.V.P. (€)
DUB185, DUB186, UB100D, UB101D, UB1103	1	191M34-3	0088381572026	14,90

**Depósito coletor de pó**



Modelo	Unds.	Código	EAN	P.V.P. (€)
LS0714, LS0714F, LS0714FL, LS1216, LS1216FL, LS1216L	1	194175-6	0088381349994	40,00



**Kit de aspiração para 4014N**



Bocal, tubo de aspiração reto, tubo de aspiração flexível e conetor.

Modelo	Unds.	Código	EAN	P.V.P. (€)
DUB185, DUB186, UB100D, UB101D, UB1103	1	196643-5	0088381437325	14,70
UB1100, UB1101		191750-9	0088381125130	14,30

**Depósito do pó**



Modelo	Unds.	Código	EAN	P.V.P. (€)
Sopradores	DUB185, DUB186, UB100D, UB101D, UB1103	122321-1	-	3,50
Cortadores de diamante	4100K, DCC500, DCC501	126738-0	0088381589802	6,40
Lixadoras de fita	9924DB	122296-4	0088381116282	14,10
	9404, 9903	122591-2	0088381154239	12,70
	9403	122562-9	0088381148184	14,10
	9910, 9911	122548-3	0088381146784	5,80
Serra de incisão	SP6000	122562-9	0088381148184	14,10
Serras de esquadria, Serras de esquadria telescópicas e Serras de mesa	DLS111, DLS211, DLS714, LS003G, LS004G, LS0714/F/FL/L, LS1019, LS1019L, LS1030N, LS1040/F, LS1216/F/FL/L, LS1219/L, LF1000, LHF1040F	122852-0	0088381356602	3,80
	LH1201FL	JM23100501	0088381373654	3,70
	LS0815F/FL, LH1201FL	JM23510010	0088381447348	7,20
	DLS600	122884-7	-	6,40
Plainas	1100/N	STEX122312	0088381114974	68,00
	1911B	122402-1	-	-
	DKP180, DKP181, KP0810/C, KP001G, KP0800	191C21-2	0088381557450	31,00
Desbastadora de diamante	PC5001C	122853-8	0088381358637	5,20
Lameladora	DPJ180, PJ7000	123150-5	0088381403092	7,00
Lixadora orbital	BO4900, BO4900V, BO6030	151517-7	0088381150859	8,80
Lixadora rotorbital	DBO180, DBO480, DBO481, DBO482, BO4556, BO4557, BO4565, BO4566, BO5030, BO5040, BO50412	135222-4	0088381435918	4,90



# ROBOT ASPIRADOR

**DRC300**

**Mapeamento com sensor LIDAR (2D)  
e sensor da câmara**



**18V**  
LITHIUM-ION

**LXT**  
Lithium-ION EXTREMA TECNOLOGIA

**BL**  
MOTOR

**HEPA**  
filter

## Controlo remoto + Modo de limpeza livre



No modo de limpeza livre,  
pode ser iniciada imediatamente  
sem necessidade de mapear a área.



## Fácil manutenção e limpeza



Ni-Cd  
Ni-Mh

**MAK  
PAC**

**SAT**

# *Níveis laser*



Tripés



Tipo	Descrição	Rosca	Unds.	Código	EAN	P.V.P. (€)
1	Tripé de alumínio 1,65M máx.	5/8"	1	P-81088	88381449564	140,00
2	Tripé de alumínio 2,70M máx.	5/8"	1	P-81315	88381451291	269,00
3	Tripé 1800 para SK209	1/4"	1	TKOLM4001F	88381442374	151,00
4	Tripé 2900 para SK209	1/4"	1	TKOLM5030F	88381442381	218,00
5	Tripé de alumínio 1,15m máx SK700D	1/4"	1	LE00874658	088381539876	110,00



Recetores



Descrição	Unds.	Modelo	Código	EAN	P.V.P. (€)
Recetor (inclui suporte)	1	SK209	TKOLDG301G	0088381488853	343,00
Recetor (inclui suporte) LR150	1	SKR200	LE00796587	3240890394156	353,00
Suporte recetor	1	SKR200	LE00784968	3240890394200	71,00
Comando à distância SKR200	1	SKR200	LE00796588	3240890394163	65,00
Recetor Funciona como comando	1	SK104Z SK103PZ	LE00837085	0088381488877	179,00
Recetor Inclui suporte	1	SK700D SK700GD	LE00855702	0088381535366	236,00
Suporte recetor	1	SK700D	LE00837096	-	54,00
Recetor LDG	1	SK10G	TKOLDG501G	-	243,00







Suportes



	Descrição	Modelo	Unds.	Código	EAN	P.V.P. (€)
1	Suporte parede	SK105D SK105DG SK106D SK106DG SK700D SK700GD	1	LE00785637	3240890328847	131,00
2	Suporte parede	SK105D SK105DG SK106D SK106DG SK700D SK700GD	1	LE00929104	0088381589536	83,00
3	Suporte simples parede	SK105D SK105DG SK106D SK106DG, SK102 SK103P SK104	1	LE00870131	0088381528726	33,00
4	Suporte parede magnético	SK105D SK105DG SK106D SK106DG SK102 SK103P SK104	1	LE00870134	0088381528733	46,00
5	Suporte parede	SK105D SK105DG SK106D SK106DG SK102 SK103P SK104	1	LE00870137	0088381528757	77,00
6	Suporte magnético	SK104Z SK103PZ	1	LE00785633	3240890347763	15,40
7	Suporte parede	SKR200Z	1	LE00791661	3240890394170	104,00



**Escala de alumínio**



Comprimento	Unds.	Código	EAN	P.V.P. (€)
1,2 - 4,0 m	1	P-81309	0088381451178	99,00

**Cartões magnéticos**

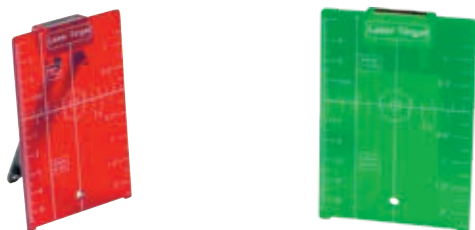

Descrição	Unds.	Código	EAN	P.V.P. (€)
Cartão magnético vermelho	1	LE00785638	3240890328830	17,90
Cartão magnético verde	1	LE00823195	0088381851923	25,00

**Bolsas de transporte**



LE00864505

Descrição	Modelo	Unds.	Código	EAN	P.V.P. (€)
Bolsa	SK104Z SK103PZ	1	LE00822220	-	31,00
Bolsa	SK105D SK105GD SK106D SK106GD	1	LE00864505	0088381549547	39,00
Bolsa	SK700D SK700GD	1	LE00929103	-	46,00

**Óculos de melhoria da visão a laser**



Descrição	Unds.	Código	EAN	P.V.P. (€)
Óculos para laser vermelho (1)	1	LE00834534	-	20,00
Óculos para laser verde (2)	1	LE00772796	-	26,00
Óculos para laser verde (1)	1	TK02100200	-	20,00

**Cabos USB**



Permite usar uma bateria LXT de 18 V quando usado com o adaptador para USB ADP05 (vendido em separado).

Descrição	Modelo	Unds.	Código	EAN	P.V.P. (€)
Cabo USB	SK209	1	199010-3	0088381519663	13,80
Cabo USB	SK105 SK106	1	199178-5	0088381528238	11,00



**Adaptador tipo bateria para SK700**



Descrição	Unds.	Código	EAN	P.V.P. (€)
Adaptador ADP09 para SK700	1	CP00000001	0088381548571	33,00



# *Roedoras, tesouras e punçionadora*



**Capacidade em corte circular JN1601 e JN3201**

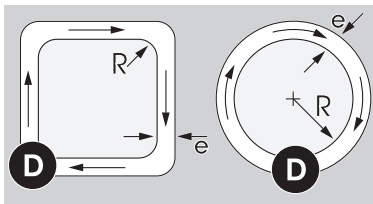

D	21 mm.	JN1601
e	5 mm.	
R	50 mm.	
D	42 mm.	JN3201
e	8 mm.	
R	128 mm.	

**JS8000**



Descrição	Unds.	Código	EAN	P.V.P (€)
Cabeça completa	1	125354-5	3240890285218	139,85
Lâmina central	1	725129-8	88381341455	73,00
Lâmina lateral	1	725130-3	88381341448	62,00

**Punções**

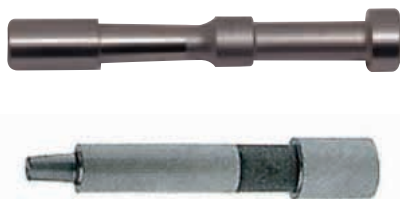

Modelo	Unds.	Código	EAN	P.V.P (€)
JN1601 DJN161	1	A-83951	0088381146630	28,00
JN3200 JN3201	1	792728-1	0088381103602	29,00

**Lâmina central**



Modelo	Unds.	Código	EAN	P.V.P (€)
JS1601	1	792534-4	0088381105477	63,00
JS1000	1	792537-8	0088381105484	81,00

**Jogo de lâminas**

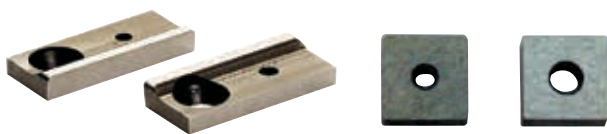

Modelo	Unds.	Código	EAN	P.V.P (€)
JS1602	1	191383-0	008838111874	31,00
JS1601	1	792533-6	0088381105453	48,00
JS1000	1	792536-0	0088381105460	48,00
JS3200 JS3201	1	792287-5	0088381103589	34,00

**Matrizes**



Modelo	Unds.	Código	EAN	P.V.P (€)
JN1601 DJN161	1	A-15051	0088381130219	24,00
JN3200 JN3201	1	792292-2	0088381103619	28,00

**Jogo calibrador de folgas**



Modelo	Unds.	Código	EAN	P.V.P (€)
JS1601	1	762013-6	0088381102162	4,10
JS3200 JS3201	1	762007-1	0088381102155	4,70

**Chaves allen**

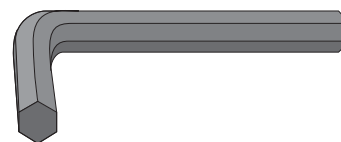

Modelo	Unds.	Código	EAN	P.V.P (€)
JS1601 JS1602 JS1000 JN3201	1	783201-2	0088381101288	1,10
JN1601	1	783208-8	0088381152624	1,10
JS3200 JS3201	1	783202-0	0088381102667	1,10

**Chaves para roedoras**



Modelo	Unds.	Código	EAN	P.V.P (€)
JN1601	1	781028-4	0088381152600	3,20
JN3200 JN3201	1	781019-5	0088381102452	3,30

**Anilha complementar**

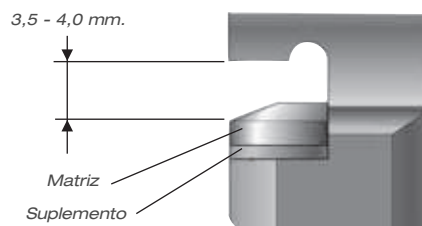

Modelo	Unds.	Código	EAN	P.V.P (€)
JN3200 JN3201	1	341796-7	0088381155298	1,10

Acessórios para DJS200

Lâminas para DJS200



725092-5



725255-3



725093-3

Descrição	Unds.	Código	EAN	P.V.P (€)
Lâmina superior	1	725092-5	-	43,00
Lâmina central	1	725255-3	-	69,50
Lâmina inferior	1	725093-3	-	46,00



Acessórios para DPP200

Base



Descrição	Unds.	Código	EAN	P.V.P (€)
Base	1	SC03801080	0088381492201	94,00

Batente deslizante



Descrição (mm)	Unds.	Código	EAN	P.V.P (€)
Batente deslizante	1	SC03300790	0088381492195	86,00



Acessórios para DPP200

Punções

Redondo



Descrição (mm)	Unds.	Código	EAN	P.V.P (€)
Punção 6	1	SC05340040	0088381493161	116,00
Punção 6,5	1	SC05340050	0088381493178	116,00
Punção 8	1	SC05340060	0088381493185	116,00
Punção 8,5	1	SC05340070	0088381493192	116,00
Punção 10	1	SC05340080	0088381493208	116,00
Punção 11	1	SC05340090	0088381493215	116,00
Punção 12	1	SC05340100	0088381493222	116,00
Punção 13	1	SC05340110	0088381493239	116,00
Punção 14	1	SC05340120	0088381493246	116,00
Punção 15	1	SC05340130	0088381493253	116,00
Punção 16	1	SC05340140	0088381493260	116,00
Punção 18	1	SC05340150	0088381493277	116,00
Punção 20	1	SC05340160	0088381493284	116,00

Batentes

Redondo



Descrição (mm)	Unds.	Código	EAN	P.V.P (€)
Batente redondo SB-6	1	SC00000203	0088381191159	116,00
Batente redondo SB-6,5	1	SC00000205	0088381191173	116,00
Batente redondo SB-8,5	1	SC00000207	0088381191197	116,00
Batente redondo SB-8,5	1	SC00000209	0088381191210	116,00
Batente redondo SB-10	1	SC00000211	0088381191234	116,00
Batente redondo SB-11	1	SC00000213	0088381491969	116,00
Batente redondo SB-12	1	SC00000215	0088381491983	116,00
Batente redondo SB-13	1	SC00000217	0088381492003	116,00
Batente redondo SB-14	1	SC00000219	0088381492027	116,00
Batente redondo SB-15	1	SC00000221	0088381492041	116,00
Batente redondo SB-16	1	SC05332710	0088381493093	116,00
Batente redondo SB-18	1	SC00000223	0088381190282	116,00
Batente redondo SB-20	1	SC05352510	0088381190770	116,00

Punções

Oval



Descrição (mm)	Unds.	Código	EAN	P.V.P (€)
Punção 6,5x10	1	SC05340200	0088381493291	159,00
Punção 6,5x13	1	SC05340210	0088381493307	159,00
Punção 8,5x13	1	SC05340220	0088381493314	159,00
Punção 8,5x17	1	SC05340230	0088381493321	159,00
Punção 9x13,5	1	SC05340240	0088381493338	159,00
Punção 9x18	1	SC05340250	0088381493345	159,00
Punção 10x15	1	SC05340260	0088381493352	159,00
Punção 10x20	1	SC05340270	0088381493369	159,00
Punção 11x16,5	1	SC05340280	0088381493376	159,00
Punção 12x18	1	SC05340290	0088381493383	159,00
Punção 13x19,5	1	SC05340300	0088381493390	159,00
Punção 14x21	1	SC05340310	0088381493406	159,00

Batentes

Oval



Descrição (mm)	Unds.	Código	EAN	P.V.P (€)
Batente oval 6,5x10	1	SC00000244	0088381190497	116,00
Batente oval 6,5x13	1	SC00000246	0088381190510	116,00
Batente oval 8,5x13	1	SC00000248	0088381190534	116,00
Batente oval 8,5x17	1	SC00000250	0088381190558	116,00
Batente oval 9x13,5	1	SC00000252	0088381190572	116,00
Batente oval 9x18	1	SC00000254	0088381190596	116,00
Batente oval 10x15	1	SC00000256	0088381190619	116,00
Batente oval 10x20	1	SC00000258	0088381190633	116,00
Batente oval 11x16,5	1	SC00000260	0088381190657	116,00
Batente oval 12x18	1	SC00000262	0088381190671	116,00
Batente oval 13x19,5	1	SC00000264	0088381190688	116,00
Batente oval 14x21	1	SC00000266	0088381190701	116,00

# Jardim



# MOTOSERRAS

## Motoserras para abate

**XGT**



**UC011**  
- 350 mm  
- 0 - 25,5 m/s  
- 52 elos



**UC012**  
- 400 mm  
- 0 - 25,5 m/s  
- 56 elos



18v + 18v → **36v**



**DUC355**  
- 350 mm  
- 0 - 20 m/s  
- 52 elos

**18v LITHION**

**NOVIDADES**



**DUC407**  
- 400 mm  
- 0 - 7,7 m/s  
- 56 elos



**DUC357**  
- 350 mm  
- 0 - 7,7 m/s  
- 52 elos

## Motoserras de altura

**XGT**

**NOVIDADES**

**UA004G**

- 300 mm  
- 0 - 20 m/s  
- 46 elos



**UA003G**

- 300 mm  
- 0 - 20 m/s  
- 46 elos

18v + 18v → **36v**

**DUC355**

- 350 mm  
- 0 - 20 m/s  
- 52 elos



**DUC355**

- 350 mm  
- 0 - 20 m/s  
- 52 elos







**XGT**  
**40V** Li-ion max



**18V + 18V** → **36V**



**18V** LITHI-ION

**Motosserras para poda**

**XGT**



**UC002**  
- 250 mm  
- 0 - 24,8 m/s  
- 46 elos



**UC003**  
- 300 mm  
- 0 - 24,8 m/s  
- 46 elos



**UC004**  
- 350 mm  
- 0 - 24,8 m/s  
- 52 elos



**UC006**  
- 350 mm  
- 0 - 25,5 m/s  
- 52 elos

**18V + 18V** → **36V**



**DUC406**  
- 400 mm  
- 0 - 20 m/s  
- 56 elos



**DUC306**  
- 300 mm  
- 0 - 20 m/s  
- 46 elos



**DUC254**  
- 250 mm  
- 0 - 24 m/s  
- 40 elos



**DUC254C**  
- 250 mm  
- 0 - 22,5 m/s  
- 60 elos



**DUC256**  
- 250 mm  
- 0 - 20 m/s  
- 40 elos



**DUC256C**  
- 250 mm  
- 0 - 20 m/s  
- 60 elos



**DUC306**  
- 115 mm  
- 5 m/s  
- 42 elos



**DUC101**  
- 100 mm  
- 8 m/s  
- 26 elos

**NOVIDADE**



**DUC252**  
- 250 mm  
- 8,3 m/s  
- 40 elos



**UC100D**  
- 100 mm  
- 8 m/s  
- 26 elos

**NOVIDADE**



**Correntes, barras e proteções para Motosserras**

Modelo	Comp.	Passo da corrente	Calibre	Corrente			Tipo	Corte	Elos	
				Código	EAN	P.V.P. (€)				
	<b>UC002G</b>	25	3/8"b.p	1,1mm/0,043	191H00-0	0088381562867	12,00	90PX	CC	40
	<b>UC003G</b>	30	3/8"b.p	1,1mm/0,043	191H01-8	0088381562874	20,00	90PX	CC	46
	<b>UC004G</b>	35	3/8"b.p	1,1mm/0,043	191H02-6	0088381562881	20,00	90PX	CC	52
	<b>UC006G</b>	25	1/4"	1,3mm/0,050	191G96-5	0088381562829	29,50	25AP	MC	60
	<b>UC011G</b>	35	0,325	1,1mm/0,043	191T91-3	0088381585095	30,00	80TXL	MC	59
	<b>UC012G</b>	40	0,325	1,1mm/0,043	191T92-1	0088381590754	32,50	80TXL	MC	64
	<b>DUC122</b>	11,5	1/4"	1,3mm/0,050	191G95-7	0088381562812	21,00	25AP	MC	42
	<b>DUC252</b>	25	3/8"b.p	1,3mm/0,050	191H08-4	0088381562942	18,00	91PX	CC	40
	<b>DUC101</b>	10	0,325	1,1mm/0,043	1910V6-4	0088381597579	14,00	80TXL	MC	26
	<b>UC100D</b>	10	0,325	1,1mm/0,043	1910V6-4	0088381597579	14,00	80TXL	MC	26
	<b>DUC254</b>	25	3/8"b.p	1,1mm/0,043	191H00-0	0088381562867	12,00	90PX	CC	40
	<b>DUC254C (carving)</b>	25	1/4"	1,3mm/0,050	191G96-5	0088381562829	29,50	25AP	MC	60
	<b>DUC256</b>	25	3/8"b.p	1,1mm/0,043	191H00-0	0088381562867	12,00	90PX	CC	40
	<b>DUC306</b>	30	3/8"b.p	1,1mm/0,043	191H01-8	0088381562874	20,00	90PX	CC	46
	<b>DUC406</b>	40	3/8"b.p	1,1mm/0,043	191H03-4	0088381562898	22,00	90PX	CC	56
	<b>DUC256C (carving)</b>	25	1/4"	1,3mm/0,050	191G96-5	0088381562829	29,50	25AP	MC	60
	<b>DUC355</b>	35	3/8"b.p	1,1mm/0,043	191H02-6	0088381562881	20,00	90PX	CC	52
	<b>DUC357</b>	35	3/8"b.p	1,1mm/0,043	191H02-6	0088381562881	20,00	90PX	CC	52
	<b>DUC407</b>	40	3/8"b.p	1,1mm/0,043	191H03-4	0088381563888	22,00	90PX	CC	52
	<b>UA003G</b>	30	3/8"b.p	1,1mm/0,043	191H01-8	0088381562874	20,00	90PX	CC	46
	<b>UA004G</b>									
	<b>DUA300</b>									
	<b>DUA301</b>									
	<b>UC3550A</b>	35	3/8"b.p	1,3mm/0,050	191H11-5	0088381562973	15,00	91PX	CC	52
	<b>UC4050A</b>	40	3/8"b.p	1,3mm/0,050	191H12-3	0088381562980	20,00	91PX	CC	52

**Correntes, barras e proteções para Motosserras**



Diâmetro lima	Lima	Barra			Tipo	Protetor			Dentes	Pinhão motor	
		Código	EAN	P.V.P. (€)		Código	EAN	P.V.P. (€)			
4,5mm	953003100	191G14-3	0088381563857	15,50	Pinhão	452093-7 <b>R</b>	0088381423649	2,10	7	3/8"	191V90-7
4,5mm	953003100	191G15-1	0088381563864	17,00	Pinhão	419288-5	0088381538466	3,50	7	3/8"	191V90-7
4,5mm	953003100	191G16-9	0088381563871	18,00	Pinhão	419288-5	0088381538466	3,50	7	3/8"	191V90-7
4,0mm	953003090	1911A1-3	-	55,00	Sólida	452093-7 <b>R</b>	0088381423649	2,10	7	1/4"	191V92-3
4,0mm	953003090	191T87-4	0088381585064	19,00	Pinhão	419288-5	0088381538466	3,50	8	0,325"	191V91-5
4,0mm	953003090	191T88-2	0088381590778	21,50	Pinhão	419242-9	0088381585835	2,80	8	0,325"	191V91-5
4,0mm	953003090	158476-6	0088381354660	21,00	Sin Pinhão	-	-	-	7	1/4"	221527-9
4,0mm	953003090	191G22-4	0088381563932	15,00	Pinhão	452093-7 <b>R</b>	0088381423649	2,10	7	3/8"	221526-1
-	198457-8	1910W0-3	0088381789561	20,00	Pinhão	-	-	-	7	0,325"	227947-5
-	198457-8	1910W0-3	0088381789561	20,00	Pinhão	-	-	-	7	0,325"	227947-5
4,5mm	953003100	191G14-3	0088381563857	15,50	Pinhão	452093-7 <b>R</b>	0088381423649	2,10	7	3/8"	199063-2
4,0mm	953003090	1911A1-3	-	55,00	Sólida	452093-7 <b>R</b>	0088381423649	2,10	7	1/4"	198259-2
4,5mm	953003100	191G14-3	0088381563857	15,50	Pinhão	452093-7 <b>R</b>	0088381423649	2,10	7	3/8"	199063-2
4,5mm	953003100	191G15-1	0088381563864	17,00	Pinhão	419288-5	0088381538466	3,50	7	3/8"	199063-2
4,5mm	953003100	191G17-7	0088381563888	19,00	Pinhão	419242-9	0088381585835	2,80	7	3/8"	199063-2
4,0mm	953003090	1911A1-3	-	55,00	Sólida	452093-7 <b>R</b>	0088381423649	2,10	7	1/4"	198259-2
4,5mm	953003100	191G16-9	0088381563871	18,00	Pinhão	419288-5	0088381538466	3,50	7	3/8"	199063-2
4,5mm	953003100	191G16-9	0088381563871	18,00	Pinhão	419288-5	0088381538466	3,50	7	3/8"	199063-2
4,5mm	953003100	191G17-7	0088381562898	19,00	Pinhão	419242-9	0088381585835	2,80	7	3/8"	199063-2
4,5mm	953003100	191G15-1	0088381563864	17,00	Pinhão	419288-5	0088381538466	3,50	7	3/8"	226992-7
4,0mm	953003090	191G24-0	0088381563956	18,00	Pinhão	419288-5	0088381538466	3,50	7	3/8"	221521-1
4,0mm	953003090	191G25-8	0088381563956	19,00	Pinhão	419242-9	0088381585835	2,80	7	3/8"	221521-1





**Calibrador de corrente**



Descrição	Unds.	Código	EAN	P.V.P. (€)
Calibrador	1	953100090	4002829111956	6,60

**Lima plana**



Descrição	Unds.	Código	EAN	P.V.P. (€)
Lima plana	1	953003060	4002829111659	6,90

**Conjunto de calibragem / afiação**



Inclui	Unds.	Código	EAN	P.V.P. (€)
Lima redonda 4mm (x2), suporte, pega (x2) e calibrador de profundidade.	1	D-72154	0088381568340	25,00
Lima redonda 4,5mm (x2), suporte, pega (x2) e calibrador de profundidade.	1	D-72160	0088381568357	25,00

**Lima redonda**



Ø de lima	Tipo de corrente	Unds.	Código	EAN	P.V.P. (€)
Cabo para lima		1	273646-7	-	2,45
4,0 mm - 5/32"	91VG, 90SG, 80TXL, 25AP	1	953003090	4002829111703	2,30
4,5 mm	90PX	1	953003100	-	2,30
4,8 mm - 3/16"	95VP, 21BP	1	953003070	4002829111666	2,30
5,2 mm - 3/64"	73LP, 73DP0	1	953003110	4002829477212	2,30
5,5 mm - 7/32"	73LP, 73DP	1	953003040	4002829111628	2,30

**Conjunto porta-lima**



Ø de lima	Tipo de corrente	Unds.	Código	EAN	P.V.P. (€)
4,0 mm - 5/32"	91VG, 90SG	1	953030010	4002829111871	16,00
4,8 mm - 3/16"	95VP, 21BP	1	197712-5	-	8,00
5,5 mm - 7/32"	73LP, 73DP	1	953009000	4002829111857	14,90

**Acessórios para pistolas de ar AS001G**



Descrição	Unds.	Código	EAN	P.V.P. (€)
Bocal para locais estreitos	1	191X11-1	0088381589642	2,20



Bocal limpeza de filtros	1	191X13-7	0088381589659	2,20
--------------------------	---	----------	---------------	------



Bocal de sopro	1	191X15-3	0088381589666	2,20
----------------	---	----------	---------------	------



Bocal de insuflação	1	191X17-9	0088381589697	2,80
---------------------	---	----------	---------------	------



Bocal largo	1	191X19-5	0088381589680	5,00
-------------	---	----------	---------------	------

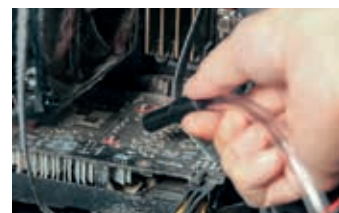

Descrição	Unds.	Código	EAN	P.V.P. (€)
Bocal tubo flexível	1	191X21-8	0088381589673	14,30

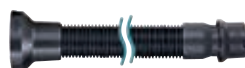

Kit mangueira de ventilação	1	191X23-4	0088381589703	18,70
-----------------------------	---	----------	---------------	-------



Bocal borracha 20-30	1	191X25-0	0088381589727	4,40
----------------------	---	----------	---------------	------



Bocal borracha 65	1	191X27-6	0088381589734	5,00
-------------------	---	----------	---------------	------



Bocal longo de cantos	1	191X78-9	0088381589741	9,40
-----------------------	---	----------	---------------	------



Filtro C completo	1	191X29-2	0088381589710	5,00
-------------------	---	----------	---------------	------



Acessórios para sopradores



**DUB186SF**



**UB101DZ**



**DUB363Z**

**Bocal**



Código	EAN	P.V.P. (€)
123245-4	0088381451215	5,80

**Bocal 430 mm**



123246-2	0088381437332	13,50
----------	---------------	-------

**Bocal longo curvo**



191G09-6	0088381561846	7,00
----------	---------------	------

**Bocal cônico**



192236-6	0088381561846	6,00
----------	---------------	------

**Mangueiras flexíveis**



196643-5	0088381437325	14,70
----------	---------------	-------

**Escova**



191M30-1	0088381572002	11,00
----------	---------------	-------

**Escova pára-brisas**



191M32-7	0088381572019	12,00
----------	---------------	-------

**Aspiração**



191M34-3	0088381572026	14,90
----------	---------------	-------

**Tubo**



**Adaptador**



**Kit de aspiração**



Código	EAN	P.V.P. (€)
191P37-5	-	75,00

**Extensão**



197888-8	-	*
----------	---	---

**Bocal plano**



197889-6	0088381475013	7,00
----------	---------------	------

\*Consultar disponibilidade

Acessórios para sopradores



DUB361Z

Tubo		
Código	EAN	P.V.P. (€)
452123-4	0088381366373	12,00



Arnês válido para:  
DUB361  
DUB184

Código	EAN	P.V.P. (€)
166094-6	0088381494977	4,20



DUB184Z

Tubo		
Código	EAN	P.V.P. (€)
183P96-3	-	10,00

Adaptador		
Código	EAN	P.V.P. (€)
191B21-6	-	*

Extensão		
Código	EAN	P.V.P. (€)
183P97-1	0088381583879	11,00



DUB362Z

Tubo		
Código	EAN	P.V.P. (€)
183R02-0	0088381585507	7,00

Adaptador		
Código	EAN	P.V.P. (€)
191J13-3	0088381560887	10,00

Bocal plano		
Código	EAN	P.V.P. (€)
197889-6	0088381475013	7,00



UB001GZ

Tubo		
Código	EAN	P.V.P. (€)
191P97-7	0088381580359	7,00

Adaptador		
Código	EAN	P.V.P. (€)
191L96-5	0088381569590	11,00

Kit limpeza para algeroz  
válido para:  
DUB184  
UB001G  
DUB363

Bocal plano		
Código	EAN	P.V.P. (€)
197889-6	0088381475013	7,00

Kit de tubos		
Código	EAN	P.V.P. (€)
191B03-8	0088381560870	86,00



UB001CZ

Tubo		
Código	EAN	P.V.P. (€)
191L96-5	0088381569590	11,00

Adaptador		
Código	EAN	P.V.P. (€)
191L96-5	0088381569590	11,00

Bocal plano		
Código	EAN	P.V.P. (€)
197889-6	0088381475013	7,00



UB002CZ

Tubos		
Código	EAN	P.V.P. (€)
413G70-6	-	10,00
162B56-4	-	13,15

Adaptador		
Código	EAN	P.V.P. (€)
1910M7-9	0088381598293	18,00

Adaptador		
Código	EAN	P.V.P. (€)
166094-6	0088381494977	4,20

Bocal plano		
Código	EAN	P.V.P. (€)
197889-6	0088381475013	7,00

Extensão		
Código	EAN	P.V.P. (€)
197888-8	-	*

\*Consultar disponibilidade

Arnês válido para: UB002

Código	EAN	P.V.P. (€)
166094-6	0088381494977	4,20

Acessórios para corta-sebes



	Modelo	Comp. (mm)	Unds.	Lâmina			Protetor da lâmina			Pala para ramagem			
				Código	EAN	P.V.P. (€)	Código	EAN	P.V.P. (€)	Código	EAN	P.V.P. (€)	
	UH201D	200	1	198408-1	0088381483766	30,00	458342-0	R	-	4,45	198401-5	0088381483728	9,10
	DUH651	650	1	196688-3	0088381437547	134,00	-	-	-	-	194681-1	0088381354349	23,00
	DUH506	500	1	1910H8-2	0088381791885	70,00	-	-	-	-	1910T1-0	0088381791861	42,00
	DUH606	600	1	1910H9-0	0088381540421	73,00	-	-	-	-	1910T2-8	0088381791878	42,00
	DUH507D	500	1	1911J1-6	-	62,00	-	-	-	-	1910T1-0	0088381791861	42,00
	DUH607D	600	1	1911J2-4	-	68,00	-	-	-	-	1910T2-8	0088381791878	42,00
	DUH601	600	1	191R53-9	0088381583503	110,00	412911-1	R	-	5,30	191R51-3	0088381583565	45,00
	DUH751	750	1	191R54-7	0088381583510	155,00	412912-9	R	-	8,70	191R52-1	0088381583572	73,00
	DUH604S	600	1	191Y03-6	-	131,50	-	-	-	-	191D33-1	-	31,00
	DUH754S	750	1	-	-	-	-	-	-	-	191D34-9	0088381559478	36,00
	UH004G	600	1	191R53-9	0088381583503	110,00	412911-1	R	-	5,30	191R51-3	0088381583565	45,00
	UH005	750	1	191R54-7	0088381583510	155,00	412912-9	R	-	8,70	191R52-1	0088381583572	73,00
	UH006G	600	1	191R55-5	0088381583527	155,00	412911-1	R	-	5,30	191R51-3	0088381583565	45,00
	UH007G	750	1	191R56-3	0088381583534	170,00	412912-9	R	-	8,70	191R52-1	0088381583572	73,00
	UH013G	600	1	191Y03-6	-	131,50	-	-	-	-	191D33-1	-	31,00
	UH014G	750	1	-	-	-	-	-	-	-	191D34-9	0088381559478	36,00
	UH4861	480	1	140830-8	-	62,00	-	-	-	-	195050-9	0088381358064	37,00
	UH5570	550	1	194663-3	0088381354141	38,00	-	-	-	-	194681-1	0088381354349	23,00
	UH6570	650	1	194666-7	0088381354172	44,00	-	-	-	-	194681-1	0088381354349	23,00
	UH5580	550	1	194671-4	0088381360401	77,00	-	-	-	-	194681-1	0088381354349	23,00
	UH6580	650	1	196688-3	0088381437547	134,00	-	-	-	-	194681-1	0088381354349	23,00







**Protetores de lâmina**

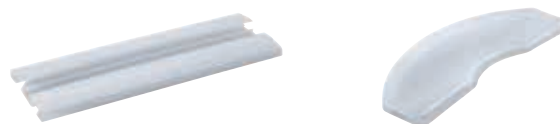

Descrição	Unds.	Código	EAN	P.V.P. (€)
Protetor de lâmina	1	458342-0	-	4,45
Protetor de lâmina	1	452055-5	0088381371407	2,65

**Lâminas corta-sebes / tesouras de erva**



195272-1



195176-7



191N24-2



Descrição	Unds.	Código	EAN	P.V.P. (€)
Lâmina DUM604	1	195272-1	0088381362399	25,00
Lâmina DUM604	1	195176-7	-	52,00
Lâmina DUM111	1	191N24-2	0088381580052	24,00
Lâmina DUM111	1	191N23-4	0088381580045	32,00

**Punho extensível**



Descrição	Unds.	Código	EAN	P.V.P. (€)
Punho extensível DUM604	1	195187-2	0088381362412	62,00
Punho extensível DUM111	1	198516-8	0088381490238	64,00

**Sistema de anti-desconexão elétrica**



• Para todos os modelos elétricos.

Para	Unds.	Código	EAN	P.V.P. (€)
Motosserras	1	158024-1	0088381122955	1,70
Corta-sebes	1	194678-0	0088381352079	2,20



Acessórios para multifunções UX01G / DUX60 / DUX18

**Sistema multifunções com motor e acessórios opcionais versáteis, ideais para uma vasta gama de aplicações.**

# Motores multifunções a bateria.

**12 em 1**

**Uma ferramenta, múltiplas aplicações...**

**XGT**

**Agora também com bateria XGT**



**Acessórios para motores multifunções**



Prolongador	1	191E27-2	0088381558600	126,00
-------------	---	----------	---------------	--------



Descrição	Unds.	Código	EAN	P.V.P. (€)
Bomba submersível	1	DEAPF400MP		240,00



Descrição	Unds.	Código	EAN	P.V.P. (€)
Corta-sebes para solo	1	198068-9	008838473620	355,00



Corte rotativo	1	191M75-9	-	496,00
Corte rotativo + barra	1	191M56-3	0088381572132	546,00



Roçadora	1	198768-1	0088381518727	130,00
	1	195663-6	0088381376853	120,00



Motosserra	1	191T38-7	0088381581271	193,00
------------	---	----------	---------------	--------



Cultivador	1	195717-9	008838398060	287,00
------------	---	----------	--------------	--------



Aparador	1	196752-0	0088381437011	161,00
----------	---	----------	---------------	--------



Escova de limpeza	1	199318-5	0088381533942	582,00
-------------------	---	----------	---------------	--------



Aparador	1	195566-4	0088381397650	90,00
----------	---	----------	---------------	-------



Soprador	1	191P72-3	0088381580212	170,00
----------	---	----------	---------------	--------



Corta-sebes de altura reto	1	197750-7	0088381469258	244,00
Corta-sebes de altura de ângulo ajustável	1	196345-3	0088381424905	299,00



Rolo de limpeza	1	199339-7	0088381534130	610,00
-----------------	---	----------	---------------	--------





**Roçadoras**

**Discos para roçadoras**

Tipo	Medida (mm)	Interior (mm)	Espessura (mm)	Modelos recomendados	Unds.	Código	EAN	P.V.P. (€)	
	2 Pontas	255	25,4	2	DUR369A DUR369L, UR006G, UR007G, UR101C, UR201C	1	198345-9	0088381481458	18,00
	2 Pontas (Triturador)	270	25,4	2	UR012G, UR006G, DUR369A	1	199874-5	0088381546614	38,00
	3 Pontas	255	25,4	3	DUR369A, UR006G, UR007G, UR101C, UR201C	1	195299-1	0088381364935	21,95
	3 Pontas	300	25,4	3	UR012G	1	385224150	4002829752159	25,00
	4 Dentes	230	25,4	2	DUR190U/L, DUR191U/L, UR368A/L, DUR369A/L, UR002G, UR003G, UR006G, UR007G, UR016G, UR017G, UR101C, UR201C	1	DA00000169		15,45
	4 Dentes	230	25,4	1,8	DUR190U/L, DUR191U/L, UR368A/L, DUR369A/L, UR002G, UR003G, UR006G, UR007G, UR016G, UR017G, UR101C, UR201C, UX01G, DUX60	1	D-66008	0088381541077	11,00
	4 Dentes	255	25,4	2	DUR369A/L, UR006G, UR007G, UR016G, UR017G, UR101C, UR201C	1	B-14124	0088381361071	11,85
	8 Dentes	200	25,4	1,4	DUR194	1	191Y44-2	0088381590884	10,00
	8 Dentes	230	25,4	1,8	DUR190U/L, DUR191U/L, UR368A/L, DUR369A/L, UR002G, UR003G, UR006G, UR007G, UR016G, UR017G, UR101C, UR201C	1	D-73324	0088381582421	12,00
	8 Dentes	255	25,4	-	DUR369A/L, UR006G, UR007G, UR016G, UR017G, UR101C, UR201C	1	B-14146	0088381361095	13,40
	24 Dentes	225	25,4	1,8	DUR190U/L, DUR191U/L, UR368A/L, DUR369A/L, UR002G, UR003G, UR006G, UR007G, UR016G, UR017G, UR101C, UR201C	1	199872-9	0088381546638	25,00

**Adaptadores de cabeça**

Tipo de cabeça	Descrição / Medida	Unds.	Código	EAN	P.V.P. (€)
	Cabeça manual	1	385224250	4002829760161	9,50
	Cabeça T&G medium	1	381224230	4002829760147	6,00
	Cabeça T&G large	1	382224310	4002829760154	8,50
	Cabeça T&G Small	1	UA-1048	-	4,50

\* Adaptador necessário.

## Cabeças de Nylon

- As cabeças Tap&Go são de carregamento fácil. Não é necessário desmontar a cabeça para carregar o fio.
- Cinco novas cabeças de nylon para cobrir as necessidades de todos os nossos modelos de roçadoras.
- Gama simplificada para facilitar a escolha dos nossos clientes.





Tipo de cabeça		Rosca	Medida	Espessura	Modelos recomendados	Unds.	Código	EAN	P.V.P. (€)
	TAP&GO	-	-	1,6mm	ET40	1	DA00000002	0088381374033	8,00
	TAP&GO	-	-	1,6mm	DUR181	1	195858-1	0088381400176	7,00
	TAP&GO	M10 x 1.25LH	-	1,6mm	DUR193	1	191Y39-5	0088381592888	8,00
	FIXO	-	-	2,7mm	-	1	384224270	4002829757741	23,00
	FIXO	M8 x 1.25LH	-	2,0mm	DUR182L/R, DUR187L	1	123235-7	0088381498098	11,00
	MANUAL	M10 x 1.25LH	-	2,4mm	DUR190L/U, DUR191L/U, DUR192L, DUR368A, DUR368L, UR002G, UR003G, UR006G, UR007G, UR016G, UR101C, UR201C	1	385224240	4002829757734	17,00
	TAP&GO	M8 x 1.25RH	100mm	2,0mm x 4m	DUR189, UR100D	1	191D92-5	0088381559300	18,00
	TAP&GO	M8 x 1.25LH	100mm	2,0mm x 4m	DUR187L, DUR188	1	191D91-7	0088381559294	18,00
	TAP&GO	M10 x 1.25LH	100mm	2,4mm x 3m	DUR190L/U, DUR191L/U, DUR192L, DUR368A, DUR368L, UR002G, UR003G, UR006G, UR007G, UR016G, UR101C, UR201C	1	191D90-9	0088381559287	18,00
	TAP&GO	M10 x 1.25LH	127mm	2,4mm x 2m	UR012G, DUR369A/L, UR007G, UR101C, UR201C	1	191D93-3	0088381559317	26,00
	TAP&GO	M10 x 1.25LH	127mm	2,7mm x 4m	UR012G, DUR369A/L, UR007G, UR101C, UR201C	1	191Y2-9	0088381798822	30,00
	TAP&GO	Estriada	127mm	2,7mm x 4m	UR014G	1	191Y3-7	0088381798839	32,00
	TAP&GO	M8 x 1.25RH	75mm	1,65mm x 8m	UR100D, DUR184	1	198854-8	0088381519571	14,00
	TAP&GO	M8 x 1.25RH	-	2,0mm	DUR184L, DUR189	1	680224200	4002829757703	18,00
	TAP&GO	M10 x 1.25LH	-	2,4mm	DUR190L/U, DUR191L/U, DUR192L, DUR368A, DUR368L, UR002G, UR003G, UR006G, UR007G, UR016G, UR101C, UR201C	1	381224240	4002829757710	17,00
	TAP&GO	M10 x 1.25LH	-	2,7mm	UR012G, DUR369A/L, UR007G, UR101C, UR201C	1	382224300	4002829757727	20,00

**Fios de nylon**





Tipo	Descrição	Ø (mm)	Comprimento (m)	Unds.	Código	EAN	P.V.P. (€)	
Redondo	<ul style="list-style-type: none"> <li>Fio de nylon redondo 1,65 x 15 metros.</li> <li>Especial para DUR181</li> </ul>	1,65	15	1	196148-5	0088381411523	5,20	
		2,4	5	1	B-01971	0088381120494	2,45	
Redondo	<ul style="list-style-type: none"> <li>Concebido para o utilizador mais exigente no uso privado.</li> <li>Indicada para roçadoras de baixa cilindrada.</li> </ul>	3,0	4	1	B-07375	0088381349291	3,30	
		1,3	15	1	369224807	-	2,30	
Round Trim	<ul style="list-style-type: none"> <li>Concebido para o utilizador mais exigente no uso privado.</li> <li>Duas cores.</li> <li>Indicado para roçadoras de baixa cilindrada.</li> <li>O fio redondo oferece maior resistência ao ar e ao impacto.</li> </ul>	1,6	15	1	369224808	-	2,60	
		2,0	15	1	369224790	4002829756614	2,80	
		2,0	126	1	369224791	4002829756621	11,60	
		2,4	15	1	369224792	4002829756638	3,60	
Round Trim PLUS	<ul style="list-style-type: none"> <li>Concebido para uso privado e semiprofissional.</li> <li>Aumentámos a resistência ao desgaste e o ponto de fusão.</li> <li>Indicado para máquinas de média cilindrada.</li> </ul>	87	1	369224793	4002829756645	11,80		
		262	1	369224794	4002829756652	31,00		
		15	1	369224809	-	4,40		
		56	1	369224811	-	11,80		
		168	1	369224815	-	31,00		
		3,3	15	1	369224810	-	5,00	
			46	1	369224812	-	11,80	
			139	1	369224816	-	31,00	
		Square Trim PLUS	<ul style="list-style-type: none"> <li>Concebido para uso semiprofissional.</li> <li>Aumentámos a resistência ao desgaste e o ponto de fusão.</li> <li>Diminui a perda de rpm por atrito graças às suas arestas.</li> <li>Indicado para máquinas de média cilindrada.</li> </ul>	15	1	369224795	-	4,10
				69	1	369224796	-	11,80
206	1			369224797	4002829756775	31,00		
3,0	15			1	369224819	-	5,20	
	44			1	369224821	-	11,80	
	132			1	369224825	-	31,00	
3,3	15			1	369224820	-	5,20	
	36			1	369224822	-	11,80	
	109			1	369224826	-	31,00	
3,5	32			1	369224823	-	11,80	
	96			1	369224827	-	31,00	
4,0	25			1	369224824	-	11,80	
	75			1	369224828	-	31,00	
	15	1	369224798	4002829756669	5,20			
Round Trim PRO	<ul style="list-style-type: none"> <li>Concebido para uso profissional.</li> <li>Elevada resistência ao calor. Para os trabalhos mais exigentes.</li> <li>Indicado para roçadoras de alta cilindrada.</li> <li>Combina duas camadas de material com diferentes níveis de dureza.</li> </ul>	56	1	369224799	4002829756676	14,10		
		168	1	369224800	4002829756683	35,00		
		279	1	369224801	4002829756690	56,00		
		15	1	369224802	4002829756782	5,80		
Square Trim PRO	<ul style="list-style-type: none"> <li>Concebido para uso profissional.</li> <li>Elevada resistência ao calor. Para os trabalhos mais exigentes.</li> <li>Indicado para roçadoras de alta cilindrada.</li> <li>Diminui a perda de rpm por atrito graças às suas arestas.</li> <li>Combina duas camadas de material com diferentes níveis de dureza.</li> </ul>	44	1	369224803	4002829756799	14,10		
		132	1	369224804	4002829756805	36,00		
		219	1	369224805	-	56,00		
		15	1	369224802	4002829756782	5,80		
		44	1	369224803	4002829756799	14,10		



**Fios de nylon silenciosos**

Tipo	Descrição	Ø (mm)	Comprimento (m)	Unds.	Código	EAN	P.V.P. (€)
<b>Linha Quatro faces</b> 	<ul style="list-style-type: none"> <li>Fio de nylon helicoidal.</li> <li>Forma de quatro faces arredondadas que diminui o nível de ruído.</li> <li>Graças à sua forma que tem menos resistência ao ar do que a linha redonda de nylon, permite um maior volume de trabalho.</li> <li>Em comparação com outros fios, o tempo de funcionamento aumenta 20% com um único carregamento da bateria.</li> <li>Indicado para máquinas a bateria.</li> </ul>	2,0	15	1	E-01769	0088381555487	3,30
		2,0	30	1	E-01775	0088381555494	6,20
		2,0	310	1	E-01781	0088381555500	45,00
<b>Linha Quatro faces</b> 		2,4	15	1	E-01797	0088381555517	4,20
		2,4	30	1	E-01806	0088381555524	7,90
		2,4	225	1	E-01812	0088381555531	47,00
<b>Linha Quatro faces</b> 		2,7	15	1	E-01828	0088381555548	4,80
		2,7	30	1	E-01834	0088381555555	8,70
		2,7	180	1	E-01840	0088381555562	45,00



Tipo de cabeça	Rosca	Modelo	Descrição	Unds.	Código	EAN	P.V.P. (€)	
	Policut	Universal	Recomendado para modelos a Bateria	Cabeça de lâminas oscilantes substituíveis.	1	198383-1	0088381488129	30,00
	Jogo de lâminas Policut	Universal	Recomendado para Policut	12 lâminas	1	197189-4	0088381458276	24,00
	Policut curvo	Universal	Recomendado para modelos a Bateria	Cabeça de lâminas oscilantes substituíveis	1	198383-1	0088381488129	30,00
	Jogo de lâminas Policut	Universal	Para policut curvo	3 lâminas	1	198426-9	0088381488143	14,20



**Óleos**

**Óleo de 2T mineral**



Quantidade	Unds.	Código	EAN	P.V.P. (€)
100ml	1	980008106	4002829239551	2,05
1 Litro	1	980008107	4002829000274	7,20
1 Litro com doseador	1	980008112	4002829414477	12,10
5 Litros	1	980008118	4002829486030	33,00

**Óleo de 4T HD30 Monograu**



Quantidade	Unds.	Código	EAN	P.V.P. (€)
600ml	1	980008120	4002829441336	4,40

**Óleo de 4T SJ10W30 Multigrau**



Quantidade	Unds.	Código	EAN	P.V.P. (€)
80ml	1	196122-3	-	2,80
100ml	1	197010-7	0088381452731	5,50

**Óleo de 4T 5W30 Multigrau**



Quantidade	Unds.	Código	EAN	P.V.P. (€)
1 Litro	1	980008121	4002829760475	8,20

**Óleo de 2T sintético**



Quantidade	Unds.	Código	EAN	P.V.P. (€)
1 Litro	1	980008103	4002829760314	12,70

**Óleo de corrente Biotop (Biodegradável)**



Quantidade	Unds.	Código	EAN	P.V.P. (€)
1 Litro	1	980008210	4002829155028	6,40
5 Litros	1	980008211	4002829155035	31,00

**Óleo de corrente**



Quantidade	Unds.	Código	EAN	P.V.P. (€)
1 Litro	1	988002256	4002829137390	4,70

**Líquido de limpeza de correntes**



Quantidade	Unds.	Código	EAN	P.V.P. (€)
500ml	1	980008125	4002829441343	9,90



## Arneses para roçadoras



196335-6



196129-9

- Arnês profissional, muito ergonómico, perfeito para dias de trabalho longos.
- Reduz a tensão na zona lombar e nos ombros.
- Melhora a manobrabilidade.
- Amplo protetor lombar que ajuda a não carregar as ancas.
- Arnês totalmente ajustável.

Modelos	Unds.	Código	EAN	P.V.P. (€)
Todos os modelos	1	196335-6	0088381423694	55,00
	1	196129-9	0088381442459	55,00



Modelos	Unds.	Código	EAN	P.V.P. (€)
Arnês para roçadoras em PDC1200	1	191E43-4	0088381556859	14,50



122907-1

Modelos	Unds.	Código	EAN	P.V.P. (€)
Todos os modelos	1	122907-1	0088381426909	27,00



Modelos	Unds.	Código	EAN	P.V.P. (€)
Válido para roçadoras e bateria de mochila PDC01.	1	197243-4	0088381454285	6,00

## Proteção



P-47363



P-47357

Descrição	Unds.	Código	EAN	P.V.P. (€)
Viseira protetora transparente com borracha	1	P-47363	0088381977791	11,00
Viseira protetora metálica com borracha	1	P-47357	0088381977784	9,10



988000606



988000040

Descrição	Unds.	Código	EAN	P.V.P. (€)
Capacete com viseira	1	988000606	-	75,00
Proteção auditiva	1	988000040	4002829215838	42,00

**Acessórios para perfuradora DDG460**

**Conjunto suporte DDG460**



Descrição	Unds.	Código	EAN	P.V.P. (€)
Conjunto suporte	1	191P11-3	0088381576994	153,00

**Prolongador**



Comprimento (mm)	Unds.	Código	EAN	P.V.P. (€)
540	1	E-07325	0088381572460	33,00

**Lâmina**



Ø (mm)	Unds.	Código	EAN	P.V.P. (€)
50	1	E-13649	0088381592178	9,60
60	1	E-13655	0088381592185	10,20
80	1	E-13661	0088381592192	11,20
100	1	E-07630	0088381574518	12,00
150	1	E-07646	0088381574525	13,20
200	1	E-07652	0088381574532	15,50

**Adaptador para broca**



Descrição	Unds.	Código	EAN	P.V.P. (€)
Pin para brocas	1	E-07331	0088381572477	3,40

**Adaptadores**



Descrição	Unds.	Código	EAN	P.V.P. (€)
Adaptadores	1	327685-0	-	39,00
	1	327684-2	0088381580175	33,00
	1	327687-6	0088381574471	29,00

**Brocas para perfuradora DDG460**



Ø (mm)	Comp. (mm)	Unds.	Código	EAN	P.V.P. (€)
50	800	1	E-13611	0088381592147	83,00
60	800	1	E-13627	0088381592154	91,00
80	800	1	E-13633	0088381592161	98,00
100	800	1	E-07294	0088381572439	107,00
150	800	1	E-07303	0088381572446	125,00
200	800	1	E-07319	0088381572453	148,00



**Brocas de solo 3/4"**



Broca

Adaptador

Modelo	Descrição	Unds.	Código	EAN	P.V.P. (€)
DTW1001 TW001	Ø 20mm / 600 mm	1	B-54346	0088381477468	198,00
	Ø 25mm / 600 mm	1	B-54352	0088381477475	203,00
	Ø 30mm / 600 mm	1	B-54368	0088381477482	229,00
	Ø 35mm / 600 mm	1	B-54374	0088381477499	271,00
	Adaptador 3/4"	1	B-54380	0088381477505	50,00

**Brocas de solo para berbequins**



Modelo	Descrição	Unds.	Código	EAN	P.V.P. (€)
Inserção 13mm	Ø 30mm / 200 mm	1	D-75415	0088381595148	18,70
	Ø 45mm / 200 mm	1	D-75421	0088381595155	20,00
	Ø 70mm / 200 mm	1	D-75437	0088381595162	22,00
	Ø 100mm / 200 mm	1	D-75443	0088381595179	26,00
	Ø 130mm / 200 mm	1	D-75459	0088381595186	28,00

**Acessórios para DUC122 e UC120D**



Modelo	Descrição	Unds.	Código	EAN	P.V.P. (€)
DUC122	Extensão	1	195595-7	0088381398510	203,00
UC120D	Extensão 1,3 - 2,2 m.	1	192755-2	0088381146142	208,00



Modelo	Descrição	Unds.	Código	EAN	P.V.P. (€)
DUC122	Lima	1	953003090	4002829111703	2,30



Modelo	Descrição	Unds.	Código	EAN	P.V.P. (€)
DUC122	Óleo	1	199897-3	0088381582131	4,40

**Chave de fendas de regulação**



Descrição	Unds.	Código	EAN	P.V.P. (€)
Chave de fendas Philips nº2	1	783002-8	0088381102650	1,95
Regulação do carburador	1	783012-5	0088381417839	0,60



**Lâminas e acessórios para tesouras de poda**



197367-6

197366-8

Modelo	Descrição	Unds.	Código	EAN	P.V.P. (€)
DUP361	Lâmina fixa	1	197367-6	0088381465373	47,00
	Lâmina móvel	1	197366-8	0088381463720	54,00
DUP362	Lâmina fixa	1	199169-6	0088381526425	132,00
	Lâmina móvel	1	199168-8	0088381526418	105,00



A-86664

B-05016

Modelo	Descrição	Unds.	Código	EAN	P.V.P. (€)
4604D	Lâmina fixa	1	A-86664	0088381150965	49,00
	Lâmina móvel	1	B-05016	-	34,00

**Arnês para tesoura de poda DUP361 / 362**



Descrição	Unds.	Código	EAN	P.V.P. (€)
Arnês para DUP361 e DUP362	1	161377-9	0088381473750	37,00

**Lima de diamante e óleo**



Modelo	Descrição	Unds.	Código	EAN	P.V.P. (€)
4604D DUP361 DUP362	Lima de diamante	1	794530-8	0088381116893	13,20
	Óleo	1	182470-6	0088381498135	1,50



# NOVIDADES

## Carros de transporte a bateria

DCU603 - DCU604 - DCU605



**DCU603**

**Descarga manual + cuba basculante**

- Graças ao plástico impermeável pode ser carregado com líquidos.
- O interior da cuba foi concebido para facilitar a descarga.



**Capacidade**

- Sólidos: **200L**
- Líquidos: **100L**



**DCU604**

**Descarga manual + plataforma basculante**

- Ideal para embalagens ou sacos fechados.
- Alta eficiência na descarga.
- Plataforma telescópica.

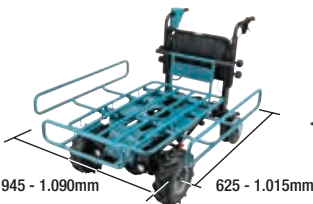

**DCU605**

**Depósito**

- Graças ao plástico impermeável, pode ser carregado com líquidos.
- Concebido para trabalhos onde não é necessária a descarga de material, por exemplo, alimentação de gado, etc.



Possui um tampão na parte inferior para descarregar líquidos ou limpar a cuba.



**18v + 18v → 36v**

Capacidade para 4 baterias que são utilizadas em pares para uma maior autonomia da ferramenta.

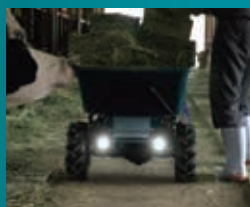

**Faróis de trabalho**

- Ligar/desligar premindo o botão na caixa da bateria.
- Desligamento automático após 10 minutos minutos de inatividade.

**Acessórios para carros de transporte DCU603, DCU604, DCU605 e DCU180**

**Plataformas**



- Plataforma de carga com tanque de esvaziamento.

Descrição	Unds.	Código	EAN	P.V.P. (€)
Cuba basculante	1	191B69-8	-	1.150,00



- Plataforma para transporte de carro de mão.  
- Apoia uma ampla variedade de tamanhos.

Descrição	Unds.	Código	EAN	P.V.P. (€)
Plataforma basculante	1	191B67-2	-	645,00



- Inclui plataforma basculante e base.

Descrição	Unds.	Código	EAN	P.V.P. (€)
Depósito	1	1911B3-6	-	1.350,00



- Área de basculamento para a plataforma de transporte ou cuba basculante.

Descrição	Unds.	Código	EAN	P.V.P. (€)
Plataforma basculante	1	191B63-0	-	995,00

**DCU603**



**DCU604**



**DCU605**



**Rodas**



- Para relva e pavimentos.

Descrição	Unds.	Código	EAN	P.V.P. (€)
Pneu de 330mm	1	1911K4-7	-	115,00



- Para áreas industriais, como fábricas ou pavilhões onde as marcas das rodas não são desejadas.

Descrição	Unds.	Código	EAN	P.V.P. (€)
Pneu cinzento de 330mm	1	1911K5-5	-	120,00



- Para áreas industriais, como fábricas ou pavilhões onde as marcas das rodas não são desejadas.

Descrição	Unds.	Código	EAN	P.V.P. (€)
Pneu cinzento de 210mm	1	1911K6-3	-	83,00

**Acessórios para DCU180**



199008-0



199009-8



191A01-6

Descrição	Unds.	Código	EAN	P.V.P. (€)
Plataforma transporte	1	199009-8	0088381519632	260,00
Cuba	1	199008-0	0088381519625	240,00
Kit rodas auxiliares	1	191A01-6	0088381545945	146,00

**Lavadoras de alta pressão**



**Pistolas**



**Lança com boquilha**



P-64917



197876-5



197824-4

Modelo	Material	Unds.	Código	EAN	P.V.P. (€)
HW102 HW111	Plástico	1	HW3320152	-	9,30
HW120	Metálica	1	HW41847		55,00
HW131RLW	Metálica	1	HW40925	8016287409254	51,00
HW132	Plástico	1	HW3640920	-	29,00
HW151	Metálica	1	HW41154	8016287411547	26,00
HW1200 HW1300 DHW080	Plástico	1	197842-2	0088381488990	24,00

Modelo	Tipo	Unds.	Código	EAN	P.V.P. (€)
HW102	Plana	1	HW3640640	-	3,70
HW102 HW111	Turbo	1	HW3320120	-	4,60
HW120	Plana	1	HW46221	-	28,00
HW131RLW	Plana	1	P-64901	0088381995429	41,00
HW131RLW	Turbo	1	P-64917	0088381995436	89,00
HW132	Plana	1	HW3641150	-	11,00
HW132	Turbo	1	HW3640940	-	11,30
HW151	Plana	1	HW40551	8016287405515	31,00
HW151	Turbo	1	HW40167	8016287401678	54,00
HW1200 HW1300 DHW080	Plana	1	197822-8	0088381484626	14,20
	Spray	1	197876-5	0088381496032	26,00
	Turbo	1	197824-4	0088381518383	14,70
	Turbo	1	191U88-8	0088381583855	37,00

**Bocais**

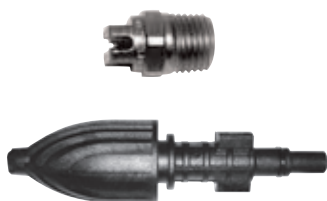

Modelo	Descrição	Unds.	Código	EAN	P.V.P. (€)
HW120	Bocal	1	HW3086	-	17,30
HW111 HW132	Bocal	1	HW3640670	-	2,45
HW1200 HW1300	Bocal rotativa	1	191U86-2	0088381583848	27,00

**Extensão**



Modelo	Material	Unds.	Código	EAN	P.V.P. (€)
HW102 HW111	Plástico	1	HW3320130	-	4,60
HW1200 HW1300 DHW080	Plástico	1	197870-7	0088381484671	49,00
HW1200 HW1300	Plástico	1	198909-9	0088381497367	35,00





### Mangueira de alta pressão



Modelo	Comprimento	uds.	Código	EAN	P.V.P. (€)
HW102	5 m	1	HW3640630	-	11,60
HW111	5,5 m / 12 mm	1	HW3641590	-	47,00
HW120	10 m	1	HW3163270	-	171,00
HW131	15 m	1	HW2500390	-	182,00
HW132	8 m	1	HW3641570	-	63,00
HW151	10 m	1	HW3083550	-	80,00

### Mangueira de desbloqueio



Para limpeza de tubos.

Modelo	Comprimento	Unds.	Código	EAN	P.V.P. (€)
HW102 HW111 HW132	8 m	1	P-64892	0088381995412	46,00
HW131 HW151	8 m	1	P-66503	0088381997034	51,00
HW102 HW111 HW132 HW151	10 m	1	HW41165	8016287411653	66,00
HW102 HW111 HW132 HW151	16 m	1	HW41167	8016287411677	105,00
HW1200 HW1300 DHW080	10 m	1	197837-5	0088381484657	27,00
	15 m	1	197840-6	0088381484664	33,00

### Extensão de mangueira de alta pressão



Modelo	Comprimento	Unds.	Código	EAN	P.V.P. (€)
HW102	5 m	1	HW41179	8016287411790	28,00
HW111 HW132	8 m	1	HW41181	8016287411813	75,00
HW1200 HW1300 DHW080	5 m	1	197845-6	0088381484688	30,00
	8 m	1	197847-2	0088381484695	41,00
	10 m	1	197850-3	0088381484701	48,00

### Escovas



\*É necessário adaptador HW3082750.

Modelo	Descrição	Unds.	Código	EAN	P.V.P. (€)
HW111 HW132 HW151* HW131RLW*	Triangular	1	HW3640950	-	6,40



Modelo	Descrição	Unds.	Código	EAN	P.V.P. (€)
HW102 HW111 HW132 HW151	Triangular	1	HW41185	8016287411851	19,30



\*É necessário adaptador HW3082750.

Modelo	Descrição	Unds.	Código	EAN	P.V.P. (€)
HW111 HW132 HW151* HW131RLW*	Rotativo	1	P-64858	0088381995375	22,00



\*É necessário adaptador HW3082750.

Modelo	Descrição	Unds.	Código	EAN	P.V.P. (€)
HW131RLW HW111 HW132 HW151	Para solo sem depósito. Adaptador HW40542 incluído	1	HW41849	-	77,00



Modelo	Descrição	Unds.	Código	EAN	P.V.P. (€)
HW131RLW HW151	Rotativo	1	HW41187	8016287411875	33,00



Modelo	Descrição	Unds.	Código	EAN	P.V.P. (€)
HW1200 HW1300 DHW080	Rotativo	1	197831-7	0088381484640	17,30



**Escovas**



Modelo	Descrição	Unds.	Código	EAN	P.V.P. (€)
HW1200 HW1300 DHW080	Escova triangular	1	197828-6	0088381489010	10,90



Modelo	Descrição	Unds.	Código	EAN	P.V.P. (€)
HW1200 HW1300 DHW080	Escova anti-salpicos	1	197864-2	0088381496001	25,00



HW41175



HW41163

Modelo	Descrição	Unds.	Código	EAN	P.V.P. (€)
HW102 HW111 HW132.	Escova para chão mini.	1	HW41175	8016287411752	59,00
HW102 HW111 HW132 HW151	Kit de sucção de água	1	HW41163	8016287411639	60,00

**Depósitos para detergente e detergente neutro**



HW3640090



P-64864



197886-2

Modelo	Descrição	Unds.	Código	EAN	P.V.P. (€)
HW102	Depósito detergente	1	HW3640090	-	3,50
Todos os modelos	Detergente neutro 1L	1	P-64864	0088381995382	18,70
	Agulha de limpeza do bocal	1	197879-9	0088381496018	2,30
HW1200 HW1300 DHW080	Recipiente de detergente	1	197886-2	0088381489003	21,00

**Adaptadores e filtros lavadora alta pressão**



197883-8



HW3082750



197867-6



P-64870



197853-7



197873-1



1910R2-4



1910R1-6

Modelo	Descrição	Unds.	Código	EAN	P.V.P. (€)
HW131RLW HW151 HW120	Adaptador	1	HW3082750	-	13,50
Todos los modelos	Conector tipo Gardena	1	P-64870	0088381995399	10,50
HW1200 HW1300 DHW080	Casquinho de segurança	1	197867-6	0088381490221	17,40
HW1200 HW1300 DHW080	Conector rápido	1	197883-8	0088381496049	6,50
HW1200 HW1300 DHW080	Adaptador	1	197853-7	0088381484749	9,00
HW1200 HW1300 DHW080	Kit de mangueira	1	197873-1	0088381484633	37,00
HW1200 HW1300 DHW080	Kit de filtros	1	1910R2-4	-	35,00
HW1200 HW1300 DHW080	Kit de mangueira	1	1910R1-6	-	24,50

# Porta-ferramentas



## Tecnologias:

### STRAP/BELT SYSTEM

O sistema de correia com fivelas de desengate rápido nas extremidades permite mudar facilmente de um porta-ferramentas tipo saco para um cinturo de ferramentas leve na cintura. Possibilidade de guardar mais porta-ferramentas no interior.



### HEAVY-LOAD SUPPORT SYSTEM

O sistema de suporte de cargas pesadas proporciona uma ajuda adicional para transportar um conjunto de ferramentas, acessórios e porta-ferramentas muito pesados, distribuindo o peso entre a cintura e os ombros. Confortável de usar e reduz a fadiga durante o dia de trabalho graças ao amortecimento extragrosso de 20 mm.



### TOOL LOOPS SYSTEM

O sistema inovador de compartimentos especiais permite ao utilizador colocar diferentes ferramentas ou acessórios sem a necessidade de ajustes. O material de alta qualidade garante uma longa vida útil. A combinação de vários tamanhos destes compartimentos permite colocar facilmente ferramentas ou acessórios de diferentes tamanhos da forma adequada.



### CS BACKPACK CARRYING SYSTEM

O sistema de transporte de mochila mantém o porta-ferramentas no seu lugar de forma segura para as costas, para ter as mãos completamente livres. É ajustável, o que reduz a fadiga dos ombros. Inclui um bloqueio deslizante para um ajuste rápido.



### WATERPROOF BOTTOM

A base impermeável de alta qualidade é uma das grandes vantagens destes porta-ferramentas: rígida, resistente ao desgaste e impermeável, mantém as ferramentas secas e protegidas de superfícies húmidas e molhadas. A base de plástico reforçado também ajuda a manter o porta-ferramentas limpo.



### ANTI SLIP

O material antiderrapante minimiza ou até previne acidentes de trabalho por escorregamentos e quedas. A fita de polipropileno de alta qualidade tem uma superfície de borracha que ajuda a manter as ferramentas no lugar e proporciona uma proteção adicional que ajuda a prolongar a vida útil dos produtos.



### 3 LAYERS

A tecnologia de 3 camadas é uma combinação única de poliésteres e espumas que proporcionam um amortecimento e proteção extra. Concebidos para serem resistentes às intempéries, estes painéis de polipropileno incrivelmente leves são compostos por três camadas firmemente unidas entre si. A característica inovadora destes painéis é a sua Capacidade de serem colocados em qualquer espaço.

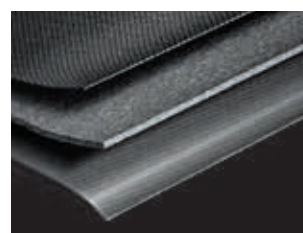



**REAL  
LEATHER**

O couro é macio no exterior e escovado no interior. Forte e resistente para uma longa vida útil, mas macio e flexível o suficiente para um grande conforto, proporcionando ao mesmo tempo uma excelente resistência, especialmente à fricção. O couro foi escolhido para o fabrico de produtos que requerem uma camada mais grossa (de 1,8 a 2,0 mm), o que garante a mais alta qualidade.



**DURABLE  
RIVETING**

O rebite duradouro proporciona uma resistência verdadeiramente inquebrável. Rebites autoperfurantes resistentes de uma só peça com arruelas, que são utilizadas em todas as zonas com alta tensão. As arruelas são utilizadas para uma maior resistência num ou em ambos os lados em locais estratégicos, para cima e para baixo.



**LOOP-CLIP  
SOLUTION**

A fixação com mosquetão ao cinto é um sistema inovador que permite fixar cada saco de modo fácil, mas seguro. O sistema de bloqueio exclusivo protege a ferramenta ou o acessório contra quedas. Nunca foi tão fácil fixar as suas ferramentas.



**ELASTIC  
LOOPS**

Os compartimentos elásticos especiais fixam e mantêm as ferramentas no lugar durante o transporte. Oferece uma grande flexibilidade na organização de ferramentas e acessórios. Estão disponíveis numa ampla variedade dos nossos produtos para garantir a máxima utilização dos mesmos. Os compartimentos são capazes de adaptar-se perfeitamente a todas as ferramentas e acessórios.



**SIDE-GATE  
SOLUTION**

O suporte lateral permite colocar facilmente a ferramenta sem olhar para o porta-ferramentas. Uma função de rotação adicional garante que a ferramenta é mantida num ângulo confortável. Fabricado em aço inoxidável para uma maior longevidade do produto e fixado com quatro rebites para maior resistência.



**BELT LOOP  
HOLDER**

A correia com presilha de fixação é resistente e permite pendurar qualquer coisa com um mosquetão. Mantém a ferramenta ou o acessório seguro, permitindo que um bolso fique livre. A presilha desliza sobre o cinto e permanece engatada de forma segura.



**RAIL GUIDE  
SYSTEM**

O sistema de guia de carril é um sistema de organização extremamente versátil. Uma combinação perfeita de guias laterais de plástico e divisórias que permite a personalização de compartimentos individuais. As divisórias são fabricadas em painéis de núcleo estruturado de 3 camadas. Cada divisória pode ser movida ao longo de carris localizados nas paredes laterais.



# Sistema de correia



# STRAP

**Função de correia.**

Completamente novo no mercado: o sistema exclusivo de cinto/correia com fivelas de libertação rápida nas extremidades torna-o muito versátil. Usá-lo com uma confortável ombreira de borracha macia torna o levantamento do porta-ferramentas mais confortável. Adapta-se a todos os porta-ferramentas Makita.



**E-15431**  
Porta-ferramentas fechado



**E-15403**  
Porta-ferramentas aberto com pega



**E-15394**  
Mala porta-ferramentas reforçado



**E-15584**  
Geleira com alça



**E-15453**  
Organizador com 4 bolsas

Mais de **30** produtos com este sistema



**E-15512**  
Saco para motosserra



**E-15350**  
Cinto/Pega



**E-05670**  
Capa para guia de carril 1 m



**E-05664**  
Capa para guia de carril 1,4 m/1,5 m

**STRAP BELT SYSTEM**



**BELT**



**Função de cinto.**  
 A correia pode ser facilmente removida de qualquer porta-ferramentas e usada à cintura como um cinto de ferramentas de uso leve. A correia pode ser ajustada, tornando-a flexível e conveniente para adaptar-se às suas necessidades. Pode ser usado com qualquer porta-ferramentas Makita.



**E-15556**  
 Capa vertical para telemóvel



**E-15279**  
 Porta-ferramentas para electricista



**E-15300**  
 Porta-flexómetro



**E-05256\***  
 Porta-ferramentas com clipe



**E-05228**  
 Porta-martelo com 3 compartimentos



**E-05278**  
 Porta-flexómetro



**E-15291**  
 Porta-martelo com fecho



**E-15322**  
 Porta-tesoura de poda



**E-05599\***  
 Porta-garrafa térmica



**E-05608\***  
 Porta-termo



**E-15241**  
 Bolsa para electricista



**E-15198**  
 Saco multiusos duplo



**E-15213**  
 Bolsa para carpinteiro



**E-15207**  
 Organizador com 3 bolsas



**E-15263**  
 Porta-objetos



**E-05197**  
 Porta-pregos com fixação de martelo



**E-15154**  
 Cartucheira grande universal



**E-15176**  
 Cartucheira pequena



**E-15182**  
 Bolsa com cartucheira

\* Consultar disponibilidade





## Ícones:

### Materiais:

- Poliéster 600D**
- Poliéster 1680D**
- Couro de alta qualidade**
- Material de borracha**
- Malha**
- Material antideslizante**
- Malha respirável**
- Material triplex**
- Poliétileno de alta densidade**
- Lâmina isolante térmica**
- Correias ajustáveis**
- Gancho e mosquetão**
- Fita elástica**
- Fita de polipropileno**
- Fecho de correr**

### Ferragens e acessórios:

- Pega de plástico**
- Pega de borracha**
- Pega de metal**
- Pega de fita de polipropileno com almofada**
- Mosquetão de alumínio**
- Mosquetão**
- Base metálica**
- Botão de pressão**
- Olhais**
- Rebite**
- Cinto de orifício duplo**
- Suspensórios**
- Regulador**
- Ajuste da fita**
- Fecho do cinto**
- Grampo de libertação rápida**
- Fivela de libertação rápida**
- Alça de ombro acolchoada**
- Correia com almofada de borracha**
- Estrutura de alumínio**
- Bagagem de mão**
- Porta-pontas**
- Lateral porta-martelos**
- Porta-martelos deslizante**
- Porta-martelos fixo**
- Fita isolante para corrente**
- Clipe para fita métrica**
- Bolso para smartphone**
- Bolso para computador portátil**
- Bolso para documento**
- Compartimento para cartões de visita**
- Suporte para canetas**
- Compartimento para cutter**
- Compartimento para chave de fendas**
- Compartimento para brocas**
- Compartimento para lixas manuais**
- Compartimento para tenazes**
- Compartimento para mosquetão**





## Cinto/correia de fecho rápido

- A solução única como cinto de ferramentas de utilização ligeira.
- Adapta-se a todos os sacos e porta-ferramentas, bem como a todos os estojos de ferramentas.
- Este cinto básico é perfeito para diversas atividades de trabalho e possui uma fivela de libertação rápida.
- Serve como base para construir seu próprio conjunto personalizado de cintos com as ferramentas que precisa.

STRAP/BELT  
SYSTEM



A solução única para usar como cinto de ferramentas manuais.

Medidas (C x L x A)	Peso (Kg)	Capacidade (L)	Unds.	Código	EAN	P.V.P (€)
1300 x - x 38 mm	0,18	-	1	E-15350	0088381598538	12,70

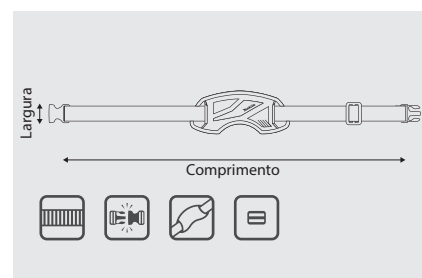

- 1 Fivela de polipropileno de 40mm.
- 2 Ombreira com desenho ergonómico.
- 3 Ajuste de aperto.
- 4 Correia de alta resistência em azul Makita.



Fivela de fecho rápido.



Instruções de utilização simplificadas.



Make It Right, Make It Makita

## TECNOLOGIAS

**STRAP BELT SYSTEM**

**ANTI SLIP**

**3 LAYERS**

**ELASTIC LOOPS**

**3D SHAPED POUCHES**

**SIDE-GATE SOLUTION**

**BELT LOOP HOLDER**

**DURABLE RIVETING**

**REAL LEATHER**



## Cartucheira grande universal

- 2 compartimentos laterais elásticos.
- 2 compartimentos para brocas de couro genuíno.
- Liberta as suas mãos para se mover em segurança em escadas, telhados e andaimes.
- Porta-ferramentas equilibrado: suporta a maioria dos berbequins de todas as marcas.
- Ferramentas acessíveis, apenas uma posição possível para um melhor equilíbrio.
- Fabricado em poliéster 1680D, resistente para maior durabilidade.



STRAP BELT SYSTEM

ANTI SLIP

3 LAYERS

3D SHAPED POUCHES

REAL LEATHER

DURABLE RIVETING

ELASTIC LOOPS



Cinto de couro genuíno com botão de pressão para segurar firmemente o berbequim ao subir ou descer escadas.

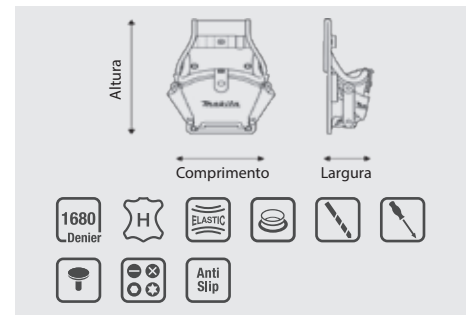

- 1 Rebites e anilhas em níquel para uma utilização resistente e duradoura.
- 2 Compartimento para brocas em pele genuína para um armazenamento prático e fácil.
- 3 Os compartimentos laterais para várias ferramentas e acessórios oferecem uma vasta gama de opções.
- 4 Fita antiderrapante com superfície de borracha na parte superior para evitar acidentes por escorregamento e quedas no local de trabalho.
- 5 Os compartimentos elásticos para brocas proporcionam um armazenamento conveniente.
- 6 Botões de pressão de aço para imobilizar a correia de segurança ao usar o berbequim.
- 7 Os dois botões de pressão fazem com que a capa seja universal para usar com máquinas de diferentes tamanhos.

Medidas (C x L x A)	Peso (Kg)	Capacidade (L)	Unds.	Código	EAN	P.V.P (€)
170 X 85 X 290 mm	0,3	-	1	E-15154	0088381598330	30,00



Muito cómodos para canhotos como destros.

Ferramentas não incluídas

## Cartucheira pequena

- Fabricada para ser duradoura e leve ao mesmo tempo.
- Pode ser usada em qualquer cinto de ferramentas Makita ou cinto de roupa normal.
- Fácil de manusear com uma mão.
- 2 compartimentos elásticos especiais para uma melhor organização.
- 2 compartimentos especiais para brocas e um suporte aberto para o adaptador de troca rápida.
- Liberta as suas mãos para se mover em segurança em escadas, telhados e andaimes.



STRAP/BELT SYSTEM

ANTI SLIP

3 LAYERS

3D SHAPED POUCHES

REAL LEATHER

DURABLE RIVETING

ELASTIC LOOPS



Cinto de couro genuíno com botão de pressão para segurar firmemente o berbequim ao subir ou descer escadas.



- 1 Os compartimentos elásticos para brocas oferecem um armazenamento prático.
- 2 Botões de pressão em aço inoxidável.
- 3 Compartimento elástico especial para adaptador de troca rápida. A sua construção aberta torna-o mais confortável de usar.
- 4 Fita antiderrapante com superfície de borracha na parte superior para evitar acidentes por escorregamento e quedas no local de trabalho.
- 5 Os rebites e arruelas niquelados proporcionam maior resistência e uma vida útil mais longa.
- 6 Botões de pressão em aço inoxidável para imobilizar a correia de segurança ao usar um berbequim.
- 7 Os compartimentos laterais para várias ferramentas e acessórios oferecem uma ampla variedade de possibilidades.
- 8 Elegante desenho de malha Makita.

Medidas (C x L x A)	Peso (Kg)	Capacidade (L)	Unds.	Código	EAN	P.V.P (€)
155 x 75 x 235 mm	0,13	-	1	E-15176	0088381598354	22,00



Muito cómodos tanto para canhotos como destros.

Ferramentas não incluídas

## Bolsa com cartucheira

- Seguro, prático e confortável. Tudo em um.
- 4 compartimentos de couro genuíno.
- 6 compartimentos elásticos para uma organização perfeita.
- Tem uma bolsa grande e profunda para ferramentas.
- O interior forrado de poliéster resistente resiste a anos de desgaste.
- Mantém as ferramentas acessíveis quando necessário.



Desenho de malha elegante Makita na parte frontal do porta-ferramentas rodeado por compartimentos de couro.

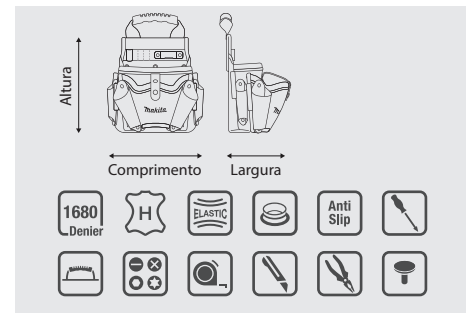

- 1 Correas antiderrapantes com superfície de borracha na parte superior.
- 2 Porta-cortador de couro genuíno.
- 3 Os dois botões de pressão de metal fazem com que a capa seja mais versátil para usar máquinas de diferentes tamanhos.
- 4 A sua pega ergonómica antideslizante proporciona um transporte mais cómodo.
- 5 Os compartimentos elásticos para brocas oferecem um armazenamento prático.
- 6 Cinta com botões de pressão fabricada em aço inoxidável.
- 7 Compartimentos elásticos para ferramentas e os seus acessórios mais essenciais.
- 8 O compartimento para chaves de fendas em pele genuína proporciona um prático armazenamento no interior.

Medidas (C x L x A)	Peso (Kg)	Capacidade (L)	Unds.	Código	EAN	P.V.P (€)
260 x 145 x 270 mm	0,55	1,5	1	E-15182	0088381598361	59,00



Compartimentos elásticos no interior.

Ferramentas não incluídas



## Bolsa multiusos dupla

- Porta-ferramentas perfeito para começar em conjunto com o cinto de ferramentas.
- 2 bolsos grandes para transportar todas as ferramentas e acessórios necessários.
- 3 compartimentos de couro genuíno.
- 4 compartimentos elásticos para ferramentas.
- A presilha para pendurar várias ferramentas e acessórios permite um armazenamento rápido.
- Forro interior de poliéster durável para resistir a anos de desgaste.



A presilha para pendurar várias ferramentas e acessórios oferece um armazenamento fácil e rápido.



- 1 Porta-chaves de fendas em pele genuína.
- 2 Compartimento largo de couro genuíno para cortador.
- 3 O bolso frontal tem muitas possibilidades e também proporciona uma rápida identificação das ferramentas.
- 4 Presilha para pendurar várias ferramentas e acessórios.
- 5 Banda elástica especial para chaves de fendas e outras ferramentas pequenas.
- 6 Correias antiderrapantes com superfície de borracha.
- 7 Bolso principal com cinta antiderrapante.
- 8 O rebite extra da bolsa proporciona uma vida útil mais longa.

Medidas (C x L x A)	Peso (Kg)	Capacidade (L)	Unds.	Código	EAN	P.V.P (€)
290 x 145 x 270 mm	0,66	2,9	1	E-15198	0088381598378	41,00



Porta-ferramentas elásticos no interior.

Ferramentas não incluídas

## Bolsa para eletricitistas

- Concebida para responder às necessidades do eletricitista profissional.
- 12 compartimentos elásticos na parte dianteira.
- 8 fitas antiderrapantes.
- 3 presilhas elásticas nos lados.
- 2 grandes bolsos principais.
- 1 compartimento de couro e 2 suportes em poliéster nas laterais.

STRAP BELT SYSTEM

ANTI SLIP

3 LAYERS

3D SHAPED POUCHES

REAL LEATHER

DURABLE RIVETING

ELASTIC LOOPS



Os compartimentos elásticos adicionais dentro do porta-ferramentas mantêm as suas ferramentas seguras, bem organizadas e no lugar.

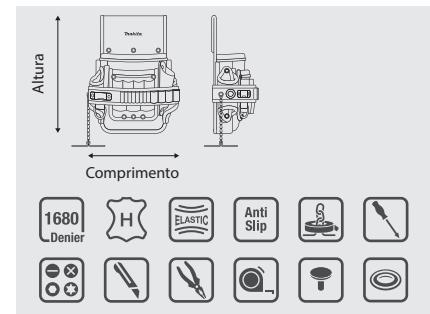

Medidas (C x L x A)	Peso (Kg)	Capacidade (L)	Unds.	Código	EAN	P.V.P (€)
250 x 125 x 310 mm	0,55	1,70	1	E-15241	0088381598422	43,00



- 1 Fitas antiderrapantes com superfície de borracha na parte superior.
- 2 Compartimento de couro genuíno para cortador.
- 3 Compartimento elástico para chaves de fendas.
- 4 Porta-fita métrica em aço inoxidável.
- 5 Possibilidade de prender um mosquetão na presilha.
- 6 Gancho em T.
- 7 Compartimento elástico externo fora do bolso principal.
- 8 Compartimento para ferramentas em poliéster de borracha resistente.
- 9 Bolso frontal para qualquer tipo de ferramenta de eletricitista.
- 10 Compartimento lateral adicional fabricado em material de 3 camadas.



Bolso principal para guardar ferramentas de eletricitista

Ferramentas não incluídas



## Organizador com 3 bolsas

- 3 bolsos espaçosos para uma variedade de ferramentas e acessórios.
- 2 compartimentos de couro genuíno.
- Transporta tudo: pregos, peças, ferramentas, parafusos, lápis, etc.
- Capaz de ser operado com uma mão.
- Todas as ferramentas necessárias ao seu alcance.
- Contém vários bolsos e compartimentos para uma organização perfeita.



STRAP/BELT SYSTEM

ANTI SLIP

3 LAYERS

3D SHAPED POUCHES

REAL LEATHER

DURABLE RIVETING

ELASTIC LOOPS



Os compartimentos extra dentro da bolsa localizados na parede traseira mantêm as suas ferramentas seguras e protegidas.



Medidas (C x L x A)	Peso (Kg)	Capacidade (L)	Unds.	Código	EAN	P.V.P (€)
320 x 145 x 270 mm	0,67	3,3	1	E-15207	0088381598385	52,00



- 1 O porta-cinzel, fabricado em couro genuíno, extrarrebitado, protege a ferramenta corretamente.
- 2 A presilha para pendurar várias ferramentas e acessórios oferece um armazenamento extra fácil e rápido.
- 3 A sua pega ergonómica com cinta antideslizante proporciona um transporte cómodo.
- 4 O compartimento de aço inoxidável para a fita métrica suporta qualquer fita padrão de 3 a 10 m.
- 5 Compartimentos laterais elásticos para ter todas as ferramentas e acessórios essenciais ao seu alcance.
- 6 Rebites duradouros com arruelas para maior resistência.
- 7 As correias antiderrapantes com superfície de borracha na parte superior evitam acidentes por escorregamento e quedas no local de trabalho.
- 8 O organizador encaixa confortavelmente em qualquer cinto de ferramentas Makita ou cinto de roupa normal.
- 9 Logótipo da Makita visível, desenho de malha Makita.
- 10 O bolso frontal tem muitas possibilidades e também proporciona uma rápida identificação da ferramenta ou acessório.

Ferramentas não incluídas



## Bolsa para carpinteiro

- Bolsa grande ideal para carpinteiros, jardineiros e/ou todo o pessoal de manutenção.
- Organiza cuidadosamente uma variedade de ferramentas manuais e evite que elas caiam.
- Pode ser usada com qualquer ferramenta.
- 3 compartimentos de couro nas laterais.
- 3 compartimentos elásticos azuis.
- 2 presilhas para pendurar qualquer coisa com um mosquetão.



STRAP/BELT SYSTEM

ANTI SLIP

3 LAYERS

3D SHAPED POUCHES

REAL LEATHER

DURABLE RIVETING

ELASTIC LOOPS



O porta-martelo de aço inoxidável na lateral balança para manter sempre o martelo na posição vertical.

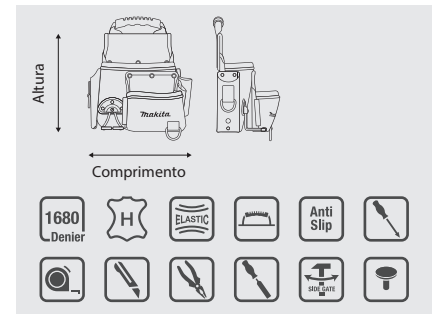

- 1 Compartimento para chaves de fendas em pele genuína.
- 2 Porta-facas de couro genuíno.
- 3 O bolso frontal oferece muitas possibilidades e permite a identificação rápida das ferramentas.
- 4 Presilha para pendurar várias ferramentas e acessórios.
- 5 O porta-martelo de aço inoxidável na lateral balança para manter sempre o martelo na posição vertical
- 6 O porta-cinzel, fabricado em couro genuíno, extrarrebicado, protege a ferramenta corretamente.
- 7 Compartimentos elástico para ferramentas nas laterais para ter todos os elementos essenciais à mão.
- 8 A pega ergonómica facilita o transporte.

Medidas (C x L x A)	Peso (Kg)	Capacidade (L)	Unds.	Código	EAN	P.V.P (€)
290 x 145 x 270 mm	0,66	2,60	1	E-15213	0088381598392	59,00



Compartimentos elásticos extra no interior do porta-ferramentas

## Porta-bolsas com correia

- Mantém as ferramentas e acessórios ao seu alcance, apenas na cintura!
- 5 bolsos espaçosos.
- 6 compartimentos de couro com resistência e durabilidade confiáveis.
- 2 presilhas para a correia incluídas.
- 10 compartimentos elásticos para um fácil acesso a ferramentas e chaves de fendas adicionais fora dos bolsos.



ANTI SLIP

3 LAYERS

3D SHAPED POUCHES

REAL LEATHER

DURABLE RIVETING

ELASTIC LOOPS

SIDE-GATE SOLUTION

BELT LOOP HOLDER



Dois bolsos principais profundos para um armazenamento seguro das ferramentas, dois bolsos frontais e um bolso mais pequeno no meio.

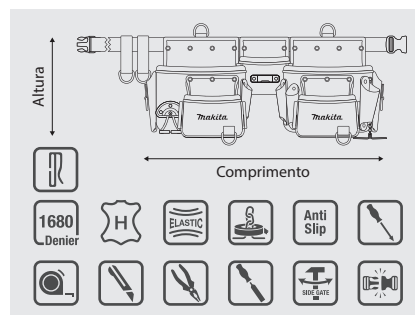

Medidas (C x L x A)	Peso (Kg)	Capacidade (L)	Unds.	Código	EAN	P.V.P (€)
640 x 145 x 270 mm	1,34	6,50	1	E-15229	0088381598408	121,00



# Três bolsas Cinco bolsos Trinta compartimentos

- 1 Presilha na extremidade do cinto para evitar que caia.
- 2 2 presilhas para o cinto incluídas.
- 3 Presilha para pendurar várias ferramentas e acessórios.
- 4 Porta-cinzel fabricado em couro genuíno.
- 5 Presilha adicional para usar com mosquetão.
- 6 Porta-martelo de aço inoxidável.
- 7 Compartimentos elásticos no interior.
- 8 Presilhas.
- 9 2 presilhas para pendurar qualquer utensílio com um mosquetão.
- 10 Porta-chaves de fendas em pele genuína.
- 11 Construção robusta com vários rebites adicionais.
- 12 Porta-fita métrica em aço inoxidável
- 13 Porta-ferramentas em couro.
- 14 Compartimento especial para chaves de fendas.
- 15 Bolso frontal com muitas possibilidades e ferramentas mais pequenas.
- 16 Compartimentos elásticos especiais no interior do bolso principal.
- 17 Correias antiderrapantes com superfície de borracha na parte superior.
- 18 Porta-cortador de couro genuíno.
- 19 Gancho em T.
- 20 Gancho em forma de fivela de libertação rápida de 40 mm.



## Cinto completo

- Distribui o peso das ferramentas uniformemente ao redor da cintura para maior conforto ao longo do dia.
- Totalmente personalizável. Pode ser carregado com vários tipos de porta-ferramentas.
- Conjunto de cinto extra confortável para serviço pesado com todo o equipamento necessário à volta da cintura.
- Capaz de armazenar tudo: peças sobressalentes, ferramentas, brocas, lápis, etc. (acessórios e ferramentas não incluídos).
- Acolchoamento de malha respirável para o calor e o frio.



STRAP/BELT SYSTEM

ANTI SLIP

3 LAYERS

3D SHAPED POUCHES

REAL LEATHER

DURABLE RIVETING

ELASTIC LOOPS

BELT LOOP HOLDER



2 bolsos principais grandes para o armazenamento seguro de ferramentas, 2 bolsos frontais de amplas possibilidades e um bolso mais pequeno no meio.

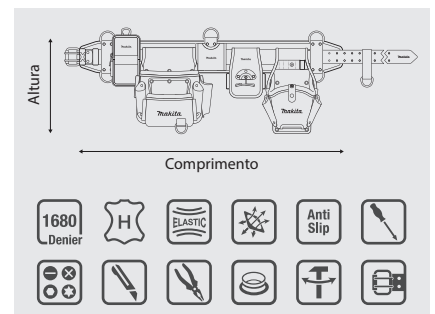

Medidas (C x L x A)	Peso (Kg)	Capacidade (L)	Unds.	Código	EAN	P.V.P (€)
310 x - x 880 mm	1,73	2,78	1	E-15235	0088381598415	149,00



Suporte para telemóvel com bolsos frontais elásticos.

# Quarenta compartimentos e diversos bolsos



Logótipo Makita visível no porta-ferramentas.

- 1 Fivela de cinto com pino duplo para maior resistência e segurança.
- 2 Presilha de cinto Makita.
- 3 Presilha de cinto de couro.
- 4 Presilha para enganchar suspensórios.
- 5 Presilha útil para pendurar qualquer utensílio com um mosquetão.
- 6 Fecho de correr.
- 7 Bolso principal plano elástico em azul Makita.
- 8 Bolso plano extra elástico na parte dianteira do cinto.
- 9 Compartimentos elásticos laterais para ferramentas pequenas.
- 10 Presilha para pendurar várias ferramentas e acessórios.
- 11 Bolso principal grande para o armazenamento seguro de todas as suas ferramentas principais.
- 12 Bolso frontal para as ferramentas mais pequenas.
- 13 Fita antiderrapante com superfície de borracha na parte superior.
- 14 Presilha adicional.
- 15 Compartimento especial para chaves de fendas em pele genuína.
- 16 Compartimento especial para cortador em pele genuína.
- 17 Logótipo da Makita claramente visível na parte de trás.
- 18 Compartimento especial elástico para chaves de fendas.
- 19 Suporte de martelo resistente forjado em aço inoxidável.
- 20 Porta-martelo com capacidade de oscilação para o manter sempre na posição vertical.
- 21 Mistura de couro e fita de polipropileno resistente.
- 22 Compartimento para chaves de fendas em pele genuína.
- 23 Compartimento elástico para brocas na cor Makita.
- 24 Botão de pressão adicional para imobilizar a correia.
- 25 Compartimento elástico para adaptador de troca rápida.
- 26 Botões de pressão para engatar e desengatar rapidamente.
- 27 Fitas antiderrapantes com superfície de borracha na parte superior.
- 28 Construção robusta com rebites de reforço.
- 29 Presilha de 2 camadas.
- 30 A parte principal do cinto é feita em couro de alta qualidade.
- 31 Fita com presilha incluída adicionalmente no cinto.
- 32 Fila dupla de furos para maior resistência e segurança.
- 33 Logótipo Makita visível gravado no cinto.



- Bolso principal grande para guardar as suas ferramentas e acessórios de forma segura.
- Compartimento especial de couro genuíno para cortador.
- Rebites para uma resistência e durabilidade verdadeiramente inquebráveis.
- Bolso frontal para fixações e ferramentas mais pequenas.

- Fabricado em poliéster 1680D resistente.
- Costuras industriais fortes para maior durabilidade.
- Correias antiderrapantes com superfície de borracha na parte superior do cinto.
- Inúmeros compartimentos elásticos para brocas e adaptadores de brocas.
- Dois botões de pressão de metal tornam-no mais versátil.



Cinto de couro genuíno com botão de pressão metálico.



Porta-ferramentas corretamente localizado num dos lados.

## Porta-pregos com porta-martelo

- Para qualquer tipo de trabalho: construtores, carpinteiros, mecânicos, eletricitas, trabalhadores, etc.
- Adapta-se confortavelmente a qualquer cinto Makita.
- Transporta tudo: pregos, peças, ferramentas, parafusos, lápis, etc.
- Confortável de usar, mantém as ferramentas indispensáveis ao seu alcance.
- Um bom começo para iniciar o seu jogo de porta-ferramentas Makita.



Os compartimentos elásticos mantêm as ferramentas seguras e fixas.



Medidas (C x L x A)	Peso (Kg)	Capacidade (L)	Unds.	Código	EAN	P.V.P (€)
180 x 105 x 185 mm	0,25	1,25	1	E-15257	0088381598439	27,00

- 1 Fitas antiderrapantes com superfície de borracha na parte superior.
- 2 Compartimentos elásticos para ferramentas mais pequenas.
- 3 Bolso principal muito versátil.
- 4 Porta-martelo de aço inoxidável.
- 5 Compartimento de couro projetado para pinças.



## Também para jardim

Porta-pregos com porta-martelo

Ferramentas não incluídas

## Porta-objetos com fecho de correr

- Liberta as suas mãos para se mover em segurança em escadas, telhados e andaimes.
- Porta-objetos perfeito para diversas atividades de trabalho.
- Adapta-se confortavelmente a qualquer cinto Makita.
- Mantém as suas ferramentas à mão quando são necessárias.
- Seguro, prático e confortável.
- Espaço para pregos, peças, ferramentas, jogos de pregos, lápis, etc.

STRAP BELT SYSTEM

3 LAYERS

3D SHAPED POUCHES

DURABLE RIVETING

ELASTIC LOOPS



Porta-fita métrica de aço inoxidável para qualquer fita métrica padrão de 3 a 10 m. A solução perfeita para as suas baterias.

Medidas (C x L x A)	Peso (Kg)	Capacidade (L)	Unds.	Código	EAN	P.V.P (€)
175 x 105 x 185 mm	0,24	1,0	1	E-15263	0088381598446	27,00



- 1 Com fecho de correr para um armazenamento seguro e à prova de pó.
- 2 Botão de pressão.
- 3 O bolso principal tem capacidade para duas baterias.
- 4 Presilha para pendurar qualquer coisa com engate de mosquetão.
- 5 Compartimentos especiais adicionais para chaves de fendas.



Porta-objetos com compartimentos elásticos

## Porta-ferramentas especial para electricista

- Pode ser transportado de 4 formas diferentes, inclusive no cinto.
- Compartimentos seguros em qualquer posição de trabalho.
- 5 compartimentos elásticos para ferramentas na parte frontal para um armazenamento prático.
- 2 compartimentos de couro para maior resistência.
- 2 compartimentos de poliéster nas laterais para uma melhor organização.



STRAP/BELT SYSTEM

REAL LEATHER

DURABLE RIVETING

ELASTIC LOOPS



Os compartimentos elásticos mantêm as ferramentas seguras e no seu lugar, imobilizando as ferramentas mais longas.

Medidas (C x L x A)	Peso (Kg)	Capacidade (L)	Unds.	Código	EAN	P.V.P (€)
185 x 55 x 205 mm	0,28	-	1	E-15279	0088381598453	27,00

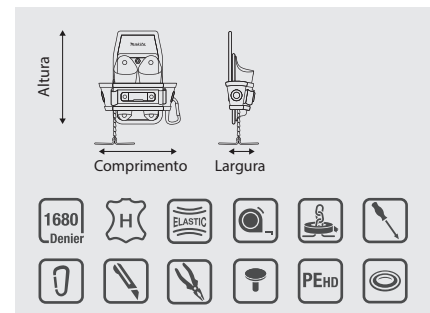

- 1 Parafuso de regulação da intensidade causada pelo balanço.
- 2 Porta-fita métrica em aço inoxidável
- 3 2 compartimentos elásticos laterais para ferramentas.
- 4 2 compartimentos laterais versáteis que prendem as ferramentas maiores e mais pesadas de forma segura.
- 5 Mosquetão preto para fixar qualquer tipo de objeto.
- 6 2 compartimentos de couro versáteis para uma organização segura de ferramentas maiores.
- 7 O gancho em T.
- 8 Costas reforçadas para uma maior ergonomia.



Parafuso para regular a intensidade do balanço

Ferramentas não incluídas



# Porta-ferramentas completamente giratório. 4 modos de ajuste



Balanço para manter as ferramentas sempre na posição vertical

- Costas de polipropileno para manter a rigidez e a forma ideal desejada.
- Compartimentos laterais elásticos para ter todas as ferramentas e acessórios à mão.
- O porta-fita métrica suporta qualquer fita padrão de 3 a 10 m.



## Porta-martelo

- O suporte de aço inoxidável adapta-se a qualquer martelo.
- 2 compartimentos elásticos adicionais para lápis ou chave de fendas.
- Adapta-se a qualquer cinto Makita.
- Fabricado em poliéster durável para resistir a anos de desgaste.
- Porta-ferramentas básico perfeito para diversas atividades de trabalho.
- Makita: a marca mais reconhecida em produtos de vestuário de trabalho.



O suporte do martelo de aço inoxidável balança para manter sempre o martelo sempre na posição vertical.

Medidas (C x L x A)	Peso (Kg)	Capacidade (L)	Unds.	Código	EAN	P.V.P (€)
880 x 30 x 100 mm	0,66	-	1	E-15291	0088381598477	16,50



- 1 Suporte do martelo em aço inoxidável.
- 2 Polipropileno para manter a rigidez.
- 3 Compartimentos elásticos para todos os acessórios essenciais.
- 4 Cinto de até 50 mm de largura.
- 5 Balanceável para manter o martelo sempre na posição vertical.

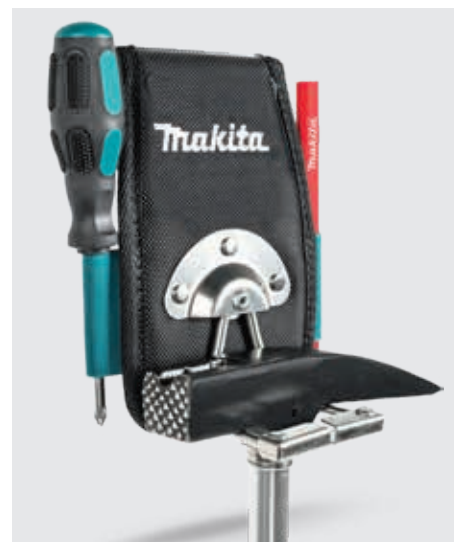

Compatível com todos os tipos de martelos de construção.

Ferramentas não incluídas

## Porta-martelo com fecho

- Porta-ferramentas em aço inoxidável para martelos ou martelos.
- 2 compartimentos elásticos laterais.
- Seguro, prático e confortável.
- Mantém as ferramentas ao seu alcance.
- Adapta-se perfeitamente a qualquer cinto Makita.
- Fabricado em poliéster durável para resistir a anos de desgaste.



STRAP BELT SYSTEM

3 LAYERS

DURABLE RIVETING

ELASTIC LOOPS



Compatível com todos os tipos de martelo para operários, carpinteiros e pessoal de construção.



Medidas (C x L x A)	Peso (Kg)	Capacidade (L)	Unds.	Código	EAN	P.V.P (€)
110 x 70 x 165 mm	0,15	-	1	E-15300	0088381598484	15,40

- 1 Porta-ferramentas em aço inoxidável para martelos.
- 2 Capaz de balançar para que o martelo esteja sempre na posição vertical.
- 3 Compartimentos elásticos para todos os acessórios essenciais.
- 4 As presilhas ajustam-se a um cinto de até 50 mm de largura.
- 5 Costas de polipropileno para manter a forma original.



Ferramentas não incluídas



## Também para jardim

Também pode usar este porta-ferramentas ao ar livre.



## Porta-flexómetro

- Porta-flexómetro ajustável e fácil de usar.
- Especialmente concebido com furos para medir sem retirar a fita.
- 2 compartimentos elásticos para lápis, chaves de fendas e outros acessórios mais pequenos.
- Fabricado em poliéster durável para resistir a anos de desgaste.
- Construído para ser duradouro, mas leve ao mesmo tempo.
- Pode ser usado em qualquer cinto de ferramentas Makita ou cinto de roupa normal.
- Pode ser usado para fitas métricas de 3 a 10 m.

STRAP/BELT SYSTEM

ANTI SLIP

3 LAYERS

3D SHAPED POUCHES

DURABLE RIVETING

ELASTIC LOOPS



Fita antiderrapante com superfície de borracha na parte superior para evitar acidentes por escorregamento e quedas no local de trabalho.



Medidas (C x L x A)	Peso (Kg)	Capacidade (L)	Unds.	Código	EAN	P.V.P (€)
110 x 80 x 165 mm	0,14	-	1	E-15338	0088381598514	13,20



- 1 Compartimentos especiais para chaves de fendas e outras ferramentas pequenas.
- 2 Fecho para telemóvel fixado com dois rebites laterais.
- 3 Aba para fixar a fita métrica com a opção de movimento tanto para cima como para baixo.
- 4 Fitas antiderrapantes com superfície de borracha na parte superior.
- 5 Adapta-se confortavelmente a qualquer cinto Makita de até 50 mm de largura.
- 6 Orifício na lateral para facilitar o uso sem a remoção da fita métrica.



A parte traseira rígida do porta-flexómetro permite a fácil remoção da fita.

## Porta-tesoura de poda

- Porta-ferramentas multiusos (especialmente para tesouras de poda) forrado com poliéster duradouro para resistir ao uso frequente do acessório.
- Forma ergonómica concebida para ser muito versátil para facas, tesouras de podar e outras ferramentas.
- 2 compartimentos elásticos adicionais nas laterais para colocar uma chave de fendas ou um lápis.
- Pequeno, mas muito útil. Mantém as ferramentas ao seu alcance.
- A presilha adapta-se a cintos de até 50 mm de largura.
- Liberta as suas mãos para se mover em segurança em escadas, telhados e andaimes, etc.

STRAP/BELT SYSTEM

ANTI SLIP

3 LAYERS

3D SHAPED POUCHES

DURABLE RIVETING

ELASTIC LOOPS



Fita antiderrapante com superfície de borracha na parte superior para evitar acidentes por escorregamento e quedas no local de trabalho.



Medidas (C x L x A)	Peso (Kg)	Capacidade (L)	Unds.	Código	EAN	P.V.P (€)
100 x 50 x 200 mm	0,08	-	1	E-15322	0088381598507	14,30

- 1 Fitas antiderrapantes com superfície de borracha na parte superior.
- 2 2 compartimentos elásticos para todos os acessórios importantes.
- 3 Forma especial para tesouras de poda.
- 4 Adapta-se confortavelmente a qualquer cinto Makita.
- 5 Rebites para durabilidade elevada.



## Também para jardim

Também pode usar este porta-ferramentas ao ar livre.

Ferramentas não incluídas



Make It Right, Make It Makita



**TECNOLOGIAS**

**STRAP / BELT SYSTEM**

**HEAVY-LOAD SUPPORT SYSTEM**

**ELASTIC LOOPS**

**BELT LOOP HOLDER**

**DURABLE RIVETING**

**REAL LEATHER**



## Cinto de porta-bolsas

- Perfeito para começar a montar um jogo de porta-ferramentas personalizado.
- Para tarefas muito pesadas. Nunca o decepcionará!
- Confortável de usar mesmo quando transporta ferramentas ou acessórios pesados.
- Acabamento extremamente duradouro, acolchoamento extra grosso e fivela de pino duplo.
- Presilha útil para cinto incluída para pendurar qualquer utensílio com um mosquetão.
- Combinação de couro resistente com fita de poliéster leve.



Pode ser usado com suspensórios.

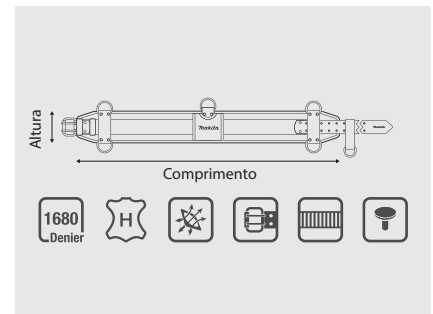

Medidas (C x L x A)	Peso (Kg)	Capacidade (L)	Unds.	Código	EAN	P.V.P (€)
880 x 30 x 100 mm	0,66	-	1	E-15366	0088381598545	49,00

- 1 Fabricado em parte de couro genuíno de alta qualidade.
- 2 Presilhas de metal.
- 3 Presilhas de metal adicionais para acessórios.
- 4 Suporte para cinto incluído.
- 5 Rebites para uma força verdadeiramente inquebrável.
- 6 As costas em malha respirável mantêm o fluxo de ar.
- 7 Presilha de couro adicional para manter o cinto bem ajustado.
- 8 Logótipo de metal da Makita na presilha do cinto.
- 9 Fivela de dois pinos para maior segurança.
- 10 Duas filas de furos de 4,5 mm de diâmetro.



Totalmente acolchoado com espuma de 20 mm de espessura para maior conforto.



## Cinto básico com fecho rápido

- Cinto básico perfeito para uma variedade de trabalhos.
- Ideal para começar a montar um kit completo de porta-ferramentas.
- Fixado com uma fivela de plástico de alta resistência.
- Presilha útil incluída para pendurar qualquer coisa com um mosquetão.
- Construído para transportar várias bolsas de trabalho leves.
- Costuras duplas à volta do cinto para garantir que os tecidos não se desprendem nem se rasgam.



Correia de polietileno no interior para manter a forma do cinto e evitar que se deforme.

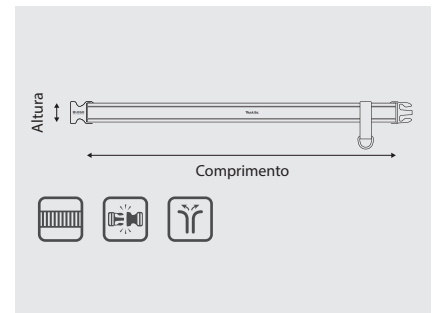

- 1 Fivela de polipropileno de 50 mm de fecho rápido.
- 2 Presilha incluída.
- 3 Adequado para ser usado com qualquer bolsa ou porta-ferramentas Makita.
- 4 Gancho e laço para ajuste de comprimento.
- 5 Logótipo da Makita gravado na fivela.

Medidas (C x L x A)	Peso (Kg)	Capacidade (L)	Unds.	Código	EAN	P.V.P (€)
1550 x - x 50 mm	0,25	-	1	E-05337	0088381566841	17,70



Logótipo da Makita gravado na fivela





## Cinto de couro com fivela de metal



- Feito a partir de uma única peça de couro genuíno.
- Construção robusta com rebites.
- Os fãs da Makita vão adorar. Ideal para o trabalho e para o uso diário.
- Fivela de metal e cinto de couro preto de 50 mm de largura.
- Presilha útil incluída para pendurar qualquer coisa com um mosquetão.
- Makita: a marca mais reconhecida em produtos de vestuário de trabalho.

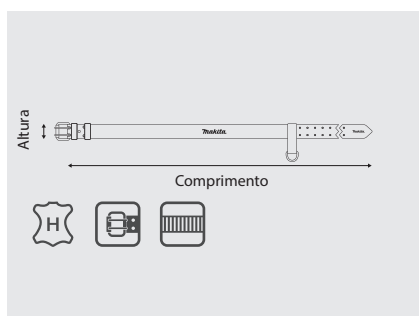

- 1 Duas filas de furos de 4,5 mm de diâmetro.
- 2 Rebites para maior resistência.
- 3 Fivela resistente e segura.
- 4 Fivela prática.
- 5 Presilha incluída.

Confeccionado com couro genuíno de uma única peça de primeira qualidade de 50 mm de largura. Adapta-se a todos os tamanhos de cintura.

Medidas (C x L x A)	Peso (Kg)	Capacidade (L)	Unds.	Código	EAN	P.V.P (€)
1380 x - x 48 mm	0,30	-	1	E-15693	0088381598811	30,00



Logótipo metálico Makita na presilha do cinto.



Make It Right, Make It Makita



**TECNOLOGIAS**

**HEAVY-LOAD  
SUPPORT SYSTEM**

**ANTI SLIP**

## Suspensórios porta-ferramentas

- Concebidos para uma utilização profissional.
- Com suporte para smartphone.
- Estrutura antiderrapante, não escorrega nem se desloca dos ombros do utilizador.
- Leve e confortável, mantendo uma elevada resistência e durabilidade.
- Ajuste da correia do peito para se adaptar ao tipo de corpo do utilizador.
- Podem ser combinados com porta-bolsas ou cintos completos para aumentar a capacidade e melhorar o desempenho.

HEAVY-LOAD  
SUPPORT SYSTEM

ANTI SLIP

Medidas (C x L x A)	Peso (Kg)	Capacidade (L)	Unds.	Código	EAN	P.V.P (€)
520 - 23 - 410 mm	0,47	-	1	E-15372	0088381598552	43,00

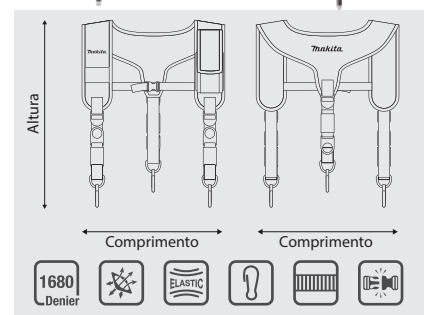

- 1 Parte inferior feita de malha 3D para melhorar a respirabilidade.
- 2 Laterais elásticas do suporte para smartphones.
- 3 Ombreiras adaptativas ergonómicas.
- 4 Reguladores de comprimento.
- 5 Sistema antiderrapante mantém as ombreiras em posição
- 6 Suporte para smartphones.
- 7 Fivela de fecho rápida de 25 mm na correia do peito.
- 8 Fitas elásticas para imobilizar as correias de ajuste de comprimento.
- 9 Ilhós para ajuste rápido do comprimento.
- 10 Mosquetões de metal para conectar ao cinto.



Com parte de fita antiderrapante para pendurar outras ferramentas.

Ferramentas não incluídas

Suspensórios

- Para suportar o peso da cintura até aos ombros.
- Totalmente ajustável, tamanho único.
- Suspensórios com 3 pontos de ajuste que retiram o peso da parte inferior das costas.
- Duradouros e fabricados com uma banda elástica azul robusta.
- Adaptam-se tanto a calças de trabalho como a calças casuais ou calças de ganga.



Concebidos para se adaptarem tanto a calças de trabalho como a calças casuais ou calças de ganga. Para verdadeiros fãs da Makita.

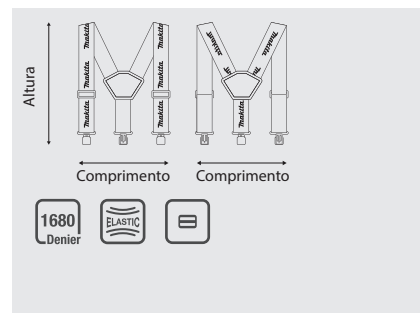

- 1 A almofada acolchoada garante o conforto do utilizador.
- 2 Fabricados com uma banda elástica azul robusta de 50 mm de largura.
- 3 Metal niquelado de alta qualidade.
- 4 Múltiplos logótipos da Makita visíveis.
- 5 Pinças de aço de alta resistência.

Medidas (C x L x A)	Peso (Kg)	Capacidade (L)	Unds.	Código	EAN	P.V.P (€)
50 x - x - mm	0,24	-	1	E-05402	0088381566919	26,00



Também para jardim

## Tamanho único para todos...

- Concebidos para distribuir o peso entre a cintura e os ombros.
- Recém-desenhados em azul Makita com grandes logótipos da Makita em branco.
- Cor e logótipo reconhecíveis com pouca visibilidade.



**Pinças de fixação resistentes**

- Suspensórios confortáveis de comprimento ajustável.
- Costuras industriais fortes para maior durabilidade.
- Concebidos para uso profissional.
- Totalmente ajustável, tamanho único.



**União acolchoada de ambos os lados**



**Tamanho único.**



Make It Right, Make It Makita

TECNOLOGIAS

STRAP BELT SYSTEM

RAIL GUIDE SYSTEM

TOOL LOOPS SYSTEM

WATERPROOF BOTTOM

CS BACKPACK CARRYING SYSTEM

ELASTIC LOOPS

DURABLE RIVETING

3 LAYERS

ANTI SLIP



## Mala porta-ferramentas reforçada

- 20 compartimentos de plástico de vários tamanhos.
- 1 bolso frontal para guardar documentação.
- 3 compartimentos elásticos para uma grande flexibilidade.
- 4 compartimentos espaçosos e totalmente ajustáveis para uma organização ideal.
- Podem ser armazenados pregos, peças, ferramentas, conjuntos de pregos, lápis, etc..
- Perfeito para um electricista, telhador, canalizador, carpinteiro e outros...



O inovador sistema de compartimentos para ferramentas permite ao utilizador colocá-las sem ter que fazer nenhum ajuste.

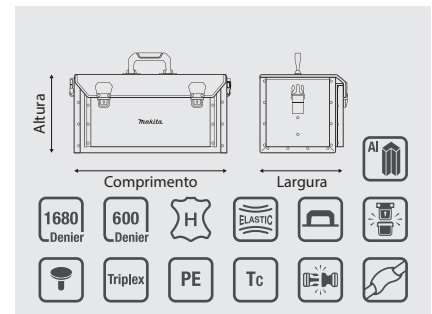

Medidas (C x L x A)	Peso (Kg)	Capacidade (L)	Unds.	Código	EAN	P.V.P (€)
505 x 295 x 265 mm	3,80	32	1	E-15394	0088381598576	125,00



- 1 Guias de carril que dividem a mala em diferentes compartimentos.
- 2 Sistema inovador de compartimentos para ferramentas manuais.
- 3 Bolso frontal para guardar documentos ou outros papéis.
- 4 Bloqueios para manter as ferramentas seguras e imobilizadas.
- 5 Parede transversal.
- 6 As bordas de alumínio evitam danos na carcaça.
- 7 Correia com fivelas de libertação rápida.
- 8 Rebites para maior resistência.
- 9 Logotipo Makita visível na frente.
- 10 Reforço de aba forte com interior reforçado com metal.



Bordas de alumínio para proteger contra danos.

## Porta-ferramentas aberto com pega

- 9 bolsas exteriores de vários tamanhos feitas de poliéster resistente.
- 2 bolsos laterais com acabamento elástico para maior conforto.
- 1 bolso frontal para documentação ou outros objetos planos.
- 8 compartimentos elásticos no interior de grande flexibilidade.
- 6 compartimentos elásticos na parte traseira para as ferramentas mais compridas.
- Até 30 ferramentas numa posição segura.



- Armazena as ferramentas na vertical para facilitar a sua identificação.
- A forma quadrada mantém o porta-ferramentas estável.
- Os compartimentos elásticos internas proporcionam uma grande capacidade de organização das ferramentas.
- Capaz de transportar até 30 ferramentas manuais de qualquer tipo.
- Desenho aberto para um acesso rápido e fácil ao interior.
- Organize cuidadosamente uma grande variedade de ferramentas manuais, ferramentas elétricas e acessórios.

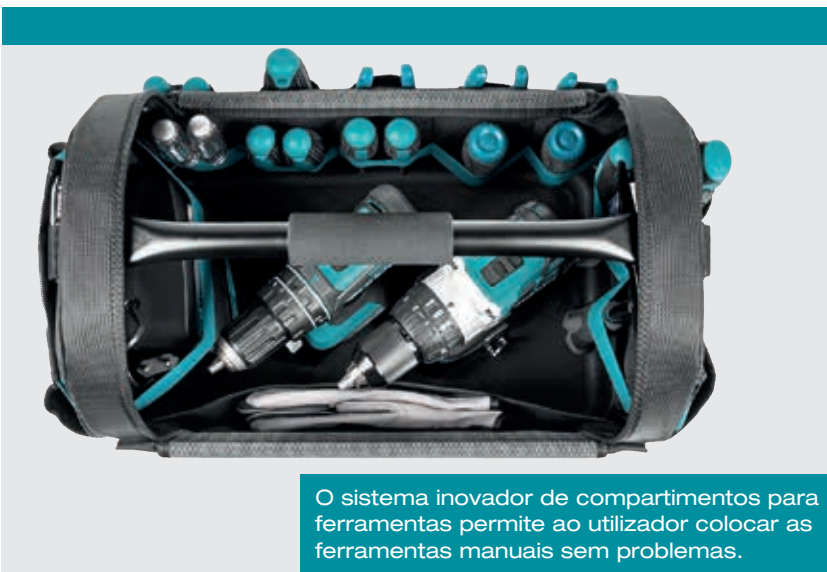

O sistema inovador de compartimentos para ferramentas permite ao utilizador colocar as ferramentas manuais sem problemas.

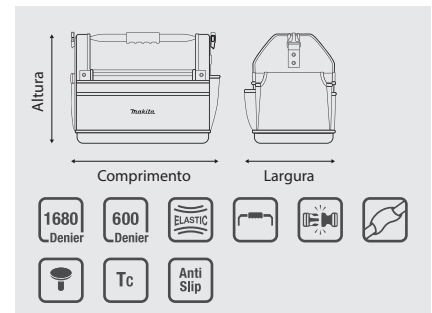

Medidas (C x L x A)	Peso (Kg)	Capacidade (L)	Unds.	Código	EAN	P.V.P (€)
490 x 310 x 355 mm	2,44	29,70	1	E-15403	0088381598583	86,00

- 1 Pega de espuma ergonómica.
- 2 Pega de aço resistente.
- 3 Correia de libertação rápida
- 4 Base da correia de aço reforçado.
- 5 Costuras industriais para a correia.
- 6 Bolso frontal para documentação.
- 7 Ombreira confortável de desenho moderno.
- 8 Correia antiderrapante com apoio de borracha para o ombro.
- 9 Compartimentos elásticos nas paredes internas do porta-ferramentas.
- 10 Compartimentos elásticos na parede traseira do bolso.





## Saco porta-ferramentas

- Mais de 20 bolsos de diferentes tamanhos para uma organização perfeita.
- Saco macio básico, perfeito para diversas de atividades de trabalho.
- 9 bolsos interiores.
- 9 bolsos exteriores.
- 4 compartimentos elásticos exteriores para ferramentas longas.
- Ideal para transportar ferramentas manuais e outros artigos pequenos.



STRAP BELT SYSTEM

ELASTIC LOOPS



Bolsos interiores e exteriores para um armazenamento seguro e ordenado.

Medidas (C x L x A)	Peso (Kg)	Capacidade (L)	Unds.	Código	EAN	P.V.P (€)
440 x 240 x 250 mm	1,67	25,80	1	E-15431	0088381598613	70,00

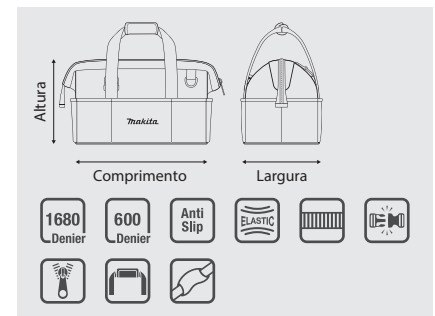

- 1 Grande abertura.
- 2 Acabamento azul da fita interior.
- 3 Fitas antiderrapantes com superfície acolchoada de borracha.
- 4 Presilha para pendurar várias ferramentas e acessórios.
- 5 Logotipo Makita visível na frente.
- 6 Correia com fivela de plástico.
- 7 Ombreira acolchoada.
- 8 Fecho de correr de borracha.
- 9 Fabricado em poliéster 1680D resistente.
- 10 A forma quadrada mantém o saco estável em todos os momentos.



Capaz de transportar uma grande variedade de ferramentas e acessórios.

## Saco porta-ferramentas

- Alta capacidade de armazenamento de 55 L
- Confortável mesmo quando se transporta elementos pesados.
- Com 10 compartimentos, 6 no interior e 4 no exterior, ideal para armazenar e organizar objetos de todos os tamanhos.
- Estrutura reforçada que melhora a sua durabilidade para suportar e transportar artigos pesados.
- Com vários tipos de pegas para transportar à mão ou sobre o ombro.
- Estrutura de três camadas que a torna resistente às condições climáticas exteriores.

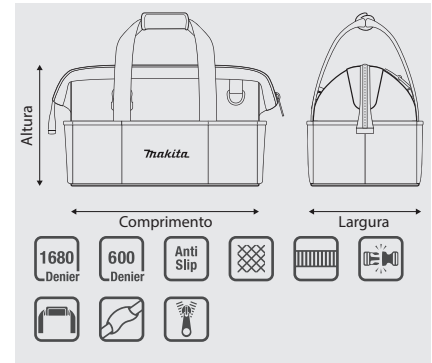

- 1 6 bolsos exteriores.
- 2 4 bolsos interiores.
- 3 Estrutura reforçada para suportar o transporte de artigos pesados.
- 4 Material de camada tripla com alta resistência a condições climáticas adversas.
- 5 Pode ser transportado à mão ou sobre o ombro.
- 6 Capacidade de 55 L.

STRAP/BELT SYSTEM ANTI SLIP 3 LAYERS



Estrutura reforçada para suportar artigos pesados e proporcionar um transporte confortável.

Medidas (C x L x A)	Peso (Kg)	Capacidade (L)	Unds.	Código	EAN	P.V.P (€)
330 x 670 x 300mm	-	55	1	E-11782	0088381584159	116,00



Com fita de velcro para unir ambas as correias ao transportá-lo à mão.



Com instruções de utilização acopladas da correia de transporte ao ombro.



## Saco trolley reforçado

- Com trolley de transporte, pode armazenar uma grande quantidade de objetos e ainda ser fácil de transportar, apesar do peso.
- Com uma boca de abertura muito larga para poder encaixar objetos de grandes dimensões.
- Com 10 compartimentos, 6 no interior e 4 no exterior, ideal para armazenar e organizar objetos de todos os tamanhos.
- Estrutura reforçada que melhora a sua durabilidade para suportar e transportar artigos pesados.
- Com vários tipos de pegas para transportar à mão ou sobre o ombro.
- Estrutura de três camadas que a torna resistente às condições climáticas exteriores.
- Alta capacidade de armazenamento de 53,5 L.

STRAP/BELT SYSTEM

ANTI SLIP

LAYERS



Com trolley incluído, facilitando o transporte mesmo quando se transporta objetos pesados.

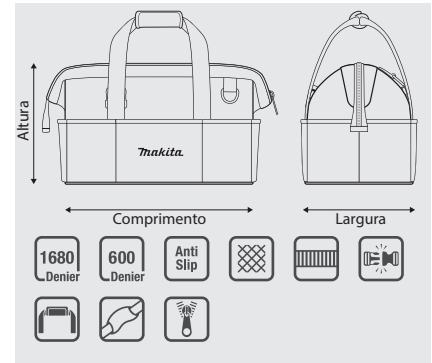

- 1 Abertura principal ampla.
- 2 Com trolley equipado.
- 3 Estrutura reforçada para suportar o transporte de artigos pesados.
- 4 Material de camada tripla com alta resistência a condições climáticas adversas.
- 5 Pode ser transportado à mão ou sobre o ombro.
- 6 Com um grande número de bolsos exteriores e interiores.

Medidas (C x L x A)	Peso (Kg)	Capacidade (L)	Unds.	Código	EAN	P.V.P (€)
330 x 680 x 330mm	-	53,5	1	E-12712	0088381588478	159,00



Com fita de velcro para unir ambas as correias ao transportá-lo à mão.



Com instruções de utilização acopladas da correia de transporte ao ombro.



Make It Right, Make It Makita



**TECNOLOGIAS**

**CS** BACKPACK CARRYING SYSTEM

**ELASTIC LOOPS**

**WATERPROOF BOTTOM**

**TOOL LOOPS SYSTEM**

## Mochila com organizador de ferramentas

- Fácil organização e transporte de qualquer tipo de ferramenta
- Ideal para trabalhadores da construção, electricistas, operários de reparação...
- Uma alternativa mais fácil de transportar do que uma mala de ferramentas.
- Permite-lhe ter as mãos livres durante o transporte.
- Pode alojar com segurança até 50 ferramentas manuais numa posição vertical.
- Com um grande número de compartimentos e engates.

WATERPROOF  
BOTTOM

CS  
BACKPACK  
CARRYING  
SYSTEM

TOOL  
LOOPS  
SYSTEM

ELASTIC  
LOOPS



Bolso exterior com fecho de aba para um armazenamento seguro.

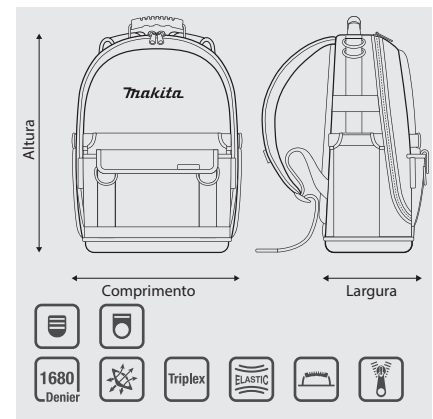

Medidas (C x L x A)	Peso (Kg)	Capacidade (L)	Unds.	Código	EAN	P.V.P (€)
390 x 230 x 490mm	2,56	22,30	1	E-15481	0088381567022	159,00



- 1 Bolso lateral para ferramentas longas.
- 2 Fita elástica para manter as ferramentas em posição e seguras.
- 3 Dois anéis para pendurar ferramentas com um mosquetão.
- 4 Painel traseiro reforçado.
- 5 Correia lateral para maior segurança das ferramentas alongadas.
- 6 Carril de plástico para armazenar todo o tipo de objetos.
- 7 Fitas para segurar as ferramentas no lugar.
- 8 Fita elástica preta para fixar ferramentas curtas.
- 9 Fita elástica azul para fixar ferramentas de tamanho médio.
- 10 Fita preta para imobilizar ferramentas alongadas.



Argolas para suportar ferramentas com mosquetão.

Ferramentas não incluídas



## Capa para smartphone

- Protege o seu smartphone de possíveis quedas.
- Ideal para guardar telemóveis grandes ou pequenos.
- Com 2 bolsos exteriores e 2 presilhas elásticas para canetas; mais um bolso especial para cartões no interior.
- Maior do que o modelo E-05583 (148 mm a 172 mm de altura).
- Com um clipe e um mosquetão para prender a cintos e a uma variedade de anéis.
- Construção de três camadas para resistência às condições climatéricas exteriores.



STRAP/BELT SYSTEM

ELASTIC LOOPS

LOOP-CLIP SOLUTION

3 LAYERS



O clipe incorporado na parte de trás torna-a ideal para prender ao cinto.

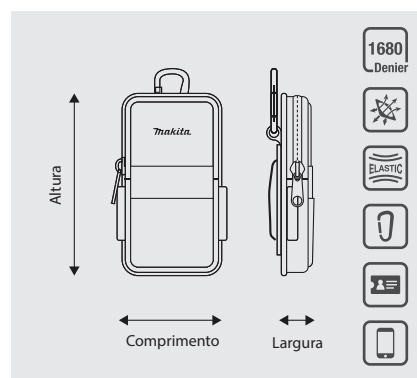

Medidas (C x L x A)	Peso (Kg)	Capacidade (L)	Unds.	Código	EAN	P.V.P (€)
90 x 40 x 165mm	-	-	1	E-15556	0088381598736	21,00

- 1 Muito cómoda e prática.
- 2 Fitas para guardar canetas.
- 3 Fitas para guardar cartões.
- 4 Mosquetão.
- 5 Clipe traseiro.
- 6 Construção em três camadas para resistir às condições climatéricas exteriores.



Bolso interior para proteger os objectos de valor.

## Capa para smartphone XL

- Proteja o seu smartphone de possíveis quedas.
- Ideal para armazenar telemóveis grandes ou pequenos.
- Com 2 bolsos exteriores e 2 fitas elásticas para canetas, mais um bolso especial para cartões no interior.
- Maior do que o modelo E-05583 (de 148 mm a 172 mm de altura).
- Com uma pinça e um mosquetão para engatar nos cintos e uma variedade de ilhós.
- Estrutura de três camadas que a torna resistente às condições climáticas exteriores.

STRAP/BELT SYSTEM

ELASTIC LOOPS

LOOP-CLIP SOLUTION

3 LAYERS



A pinça incorporada na parte posterior torna-o ideal para engatar em cintos.

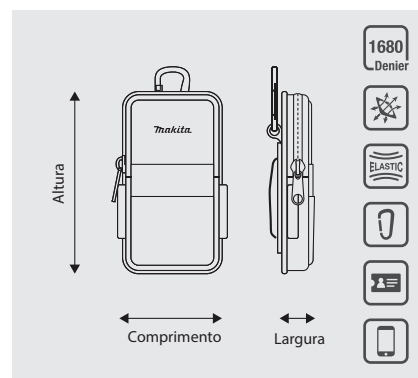

- 1 Maior do que os modelos anteriores
- 2 Fitas para armazenar canetas 2 bolsos frontais.
- 3 Mosquetão.
- 4 Pinça traseira.
- 5 Estrutura de três camadas que a torna resistente às condições climáticas exteriores.
- 6

Medidas (C x L x A)	Peso (Kg)	Capacidade (L)	Unds.	Código	EAN	P.V.P (€)
115 x 40 x 200mm	-	-	1	E-12980	0088381589963	22,00



Bolso interior para proteger os objetos de valor.



## Colete porta-ferramentas

- Uma alternativa ao porta-ferramentas tradicional.
- Liberta as suas mãos para se mover em segurança em escadas, telhados e andaimes, etc.
- Dispõe de vários bolsos exteriores para uma organização perfeita.
- Tamanho único com ajuste.
- Construção leve para o conforto do utilizador.
- Pode ser usado por cima de uma T-shirt, camisola ou casaco.



Fita de fecho bidirecional para maior conforto durante a utilização. Tamanho único.



Medidas (C x L x A)	Peso (Kg)	Capacidade (L)	Unds.	Código	EAN	P.V.P (€)
510 x 640 mm	0,81	-	1	E-15609	0088381598781	77,00

- 1 Fitas ajustáveis nas laterais em função do tamanho.
- 2 Faixa refletora para maior segurança durante o trabalho.
- 3 Plástico transparente para cartão de identificação ou cartão de crédito.
- 4 Os compartimentos elásticos mantêm as suas ferramentas fixas.
- 5 Bolso estreito com aba para um armazenamento seguro.
- 6 Bolsa larga com aba com fecho de segurança para guardar os objetos de valor de forma segura.
- 7 Desenho moderno de borracha.
- 8 Bolso com fecho de correr.
- 9 Compartimentos elásticos para canetas, lápis ou quaisquer outros objetos.
- 10 Fecho elástico para o telemóvel.



Bolsos com compartimentos elásticos e fecho de correr.



## Capas para guias de carril

- Concebidas para conter até 2 guias de carril, conectores e suportes.
- A capa adapta-se às guias de carril e protege-as de arranhões e pancadas durante o transporte e armazenamento.
- Correia de gancho ajustável, bolso frontal com fecho de correr, bolsos interiores para imobilizar as guias de carril mais curtas.
- Duradoura e leve com forro de espuma para uma proteção adicional.
- Com pega ergonómica para o seu transporte e alça para o ombro.

STRAP BELT SYSTEM

3 LAYERS



Bolso frontal para armazenar dois grampos.

Sistema de correia de gancho ajustável para maior conforto.



- 1 Bolsos interiores para imobilizar as guias de carril mais curtas.
- 2 Concebidas para armazenar duas guias de carril no seu interior.
- 3 Fecho de correr em todo o comprimento da capa para facilitar o armazenamento.
- 4 Fitas e correias ajustáveis para fixar as guias de carril.
- 5 Com forro de espuma para uma proteção adicional das guias.

Tamanho de la guía de carril	Peso (Kg)	Capacidade (L)	Unds.	Código	EAN	P.V.P (€)
1 m	1,11	-	1	E-05670	0088381567183	49,00
1,4 / 1,5 m	1,45	-	1	E-05664	0088381567176	57,00
1,9 m	-	-	1	E-10920	0088381581523	89,00
3 m	-	-	1	E-10936	0088381581530	110,00



Fita de velcro para fixação

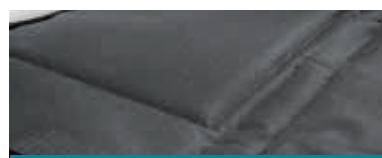

Material acolchoado para maior proteção das guias



Bolso exterior com fecho de correr

**Joelheiras de alta proteção**

- Joelheiras de alta proteção contra qualquer superfície.
- Não escorregam, marcam ou danificam as superfícies.
- Ideais para trabalhos em betão, pavimentos de madeira, trabalhos de construção civil ou qualquer outro trabalho relacionado.
- O desenho antiderrapante mantém as joelheiras no lugar.
- O acolchoamento de espuma de alta densidade proporciona o maior conforto possível.



As correias elásticas mantêm as joelheiras numa posição confortável durante todo o dia. Ideais para trabalhos em betão, pavimentos de madeira e trabalhos de construção.



- 1 A cobertura dura permite um uso prolongado ao ar livre.
- 2 Cobertura especial para uma maior estabilidade do utilizador.
- 3 As correias elásticas adaptam-se à posição do seu corpo.
- 4 Tamanho único.

Medidas (C x L x A)	Peso (Kg)	Capacidade (L)	Unds.	Código	EAN	P.V.P (€)
170 x 95 x 240 mm	0,52	-	1	E-05658	0088381567169	51,00



Joelheiras de alta proteção.

**Joelheiras flexíveis**

- O material macio e antideslizante garante uma grande durabilidade.
- Protegem os joelhos.
- Não escorregam, marcam ou danificam as superfícies.
- As fitas flexíveis mantêm as joelheiras numa posição confortável durante todo o dia.
- Perfeitas para pavimentos e ladrilhos de todo o tipo, em garagens, jardins e estaleiros de construção.



As fitas flexíveis e elásticas mantêm os joelhos no seu lugar.



Medidas (C x L x A)	Peso (Kg)	Capacidade (L)	Unds.	Código	EAN	P.V.P (€)
170 x 30 x 240 mm	0,28	-	1	E-15615	0088381598798	34,00

- 1 Fabricadas em material antiderrapante de qualidade superior.
- 2 Forro de malha respirável.
- 3 As fitas elásticas adaptam-se à posição do corpo.
- 4 Tamanho único.
- 5 Correias de banda elástica com gancho.



## Bolsa de ferramentas

- Bolsa prática e funcional com 4 faces.
- 6 bolsos exteriores em resistente poliéster 1680D.
- 6 porta-ferramentas elásticos exteriores.
- 8 porta-ferramentas internos com elástico.
- 14 presilhas para uma organização completa. Transporta tudo: pregos, peças, ferramentas, parafusos, lápis, etc.

STRAP BELT SYSTEM

ANTI SLIP

DURABLE RIVETING

ELASTIC LOOPS



Sistema de correias ajustáveis com fivelas de libertação rápida nas extremidades. As ferramentas mais compridas são fixadas por elásticos adicionais.

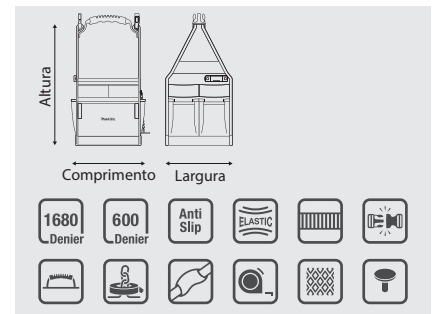

- 1 Ombreira confortável.
- 2 Fivelas de plástico de libertação rápida.
- 3 Alças de ombro antiderrapantes com superfície de borrachada.
- 4 Porta-pontas elástico.
- 5 Porta-ferramentas elástico em vários pontos da bolsa.
- 6 Presilhas elásticas para manter as ferramentas mais compridas direitas.
- 7 Suporte de fita em aço inoxidável.
- 8 Pega ergonómica para facilitar o transporte.

Medidas (C x L x A)	Peso (Kg)	Capacidade (L)	Unds.	Código	EAN	P.V.P (€)
260 x 410 x 220 mm	1,9	-	1	E-15453	0088381598637	66,00



Gancho para imobilizar o cinto de segurança.

Geleira

- Fabricada em poliéster 1680D resistente.
- Pega de transporte confortável.
- Perfeito para a construção, o escritório ou um piquenique familiar.
- Protege os alimentos do pó e dos resíduos da construção civil.
- A sua construção robusta evita fugas.
- O saco é espaçoso e pode guardar o almoço para o dia inteiro de trabalho.



3 LAYERS



Perfeita para o local de trabalho, o escritório ou um piquenique familiar.

Medidas (C x L x A)	Peso (Kg)	Capacidade (L)	Unds.	Código	EAN	P.V.P (€)
330 x 180 x 210 mm	0,45	7,5	1	E-15584	0088381598767	35,00

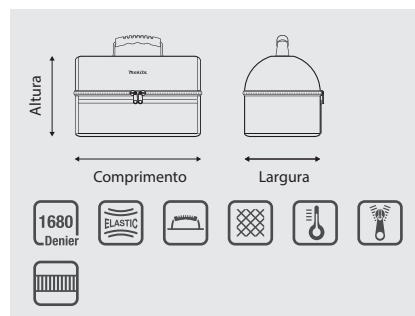

- 1 Rede prática na frente como um bolso exterior.
- 2 Fecho de correr para facilitar a abertura.
- 3 A sua forma ergonómica mantém o saco estável em qualquer altura.
- 4 Forro de papel de alumínio de fácil limpeza.
- 5 Pega de borracha para um transporte confortável.



Conteúdo não incluído



## Saco para motosserra

- Indispensável na floresta - um objecto indispensável para qualquer lenhador!
- Mantém a sua motosserra livre de danos durante o transporte ou armazenamento.
- Adapta-se às motosserras mais populares. Base de plástico incluída para estabilidade e limpeza fácil.
- Fabricado em poliéster 1680D duradouro, resistente ao desgaste e à prova de água.



STRAP BELT SYSTEM

WATERPROOF BOTTOM

ELASTIC LOOPS

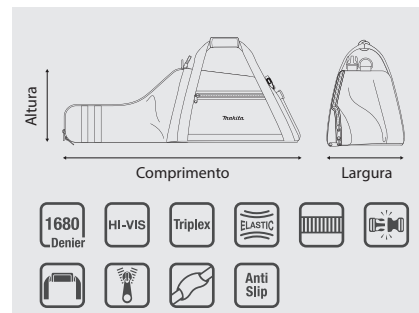

- 1 Tabuleiro de plástico específico para manter o saco limpo.
- 2 Especialmente concebido para imobilizar a motosserra.
- 3 Bolso exterior com acabamento elástico.
- 4 Faixa HI-VIS para o tornar visível no escuro.
- 5 Fundo reforçado com uma segunda camada de poliéster.

Medidas (C x L x A)	Peso (Kg)	Capacidade (L)	Unds.	Código	EAN	P.V.P (€)
900 x 260 x 270 mm	1,72	-	1	E-15512	0088381598699	78,00



# Base estável e segura para transporte e armazenamento



Especialmente construído para imobilizar a motosserra



Bolso com fecho



Bolso lateral traseiro para ferramentas manuais de motosserra

- 6 Dois fechos de correr para um acesso fácil.
- 7 Fecho de correr resistente em todo o saco.
- 8 Fitas reflectoras para a segurança na floresta.
- 9 Sistema de alça de ombro ajustável.

- 10 Fivelas de plástico de libertação rápida.
- 11 Anilha em "D" prática para pendurar tudo o que precisa.
- 12 Almofada acolchoada para um levantamento cómodo.
- 13 Cinta de polipropileno duradoura à volta do saco.

- 14 Bolso frontal com fecho de correr.
- 15 Puxador prático para uma abertura fácil.
- 16 Logótipo Makita visível na frente.
- 17 Ombreira acolchoada e confortável.



Anilha em „D” para pendurar o equipamento necessário





**STRAP BELT SYSTEM**

**ANTI SLIP**

**3 LAYERS**

**ELASTIC LOOPS**

**3D SHAPED POUCHES**

**SIDE-GATE SOLUTION**

**BELT LOOP HOLDER**

**DURABLE RIVETING**

**REAL LEATHER**





# *Malas*



## Malas empilháveis Makpac

• Oferecemos uma vasta gama de produtos para transportar o seu equipamento de trabalho nas melhores condições. Além disso, poderá expandir os seus equipamentos de trabalho de forma sistemática.



- Com o armazenamento MakPac, pode modificar as diferentes formas de armazenamento a qualquer momento, combiná-las separadamente e transportar seus dispositivos adicionais.
- No seu armazém, as possibilidades são ilimitadas.
- O número de malas que podem ser empilhadas, na verdade, é ilimitada.



• As pegas fortes e retráteis fazem com que o transporte e o armazenamento sejam feitos de forma correta.

### Quatro tamanhos diferentes

- Estão disponíveis quatro tamanhos diferentes de malas.
- Também pode optar por um plástico específico para armazenar a sua ferramenta corretamente.
- As malas MAKPAC são empilháveis, podem ser unidas ou separadas através dos quatro cliques de bloqueio manual.
- Uma vez unidas, podem ser levantadas com uma mão para o seu transporte.
- As pegas fortes e retráteis fazem com que o transporte e o armazenamento sejam feitos de forma correta.



Tipo 1



Tipo 2



Tipo 3



Tipo 4

### Malas Makpac com gavetas

• Novas malas Makpac com gavetas para acessórios



P-84311



P-84333



P-84327

- Malas Makpac com gavetas, para maior comodidade e organização. Distribui facilmente parafusos, buchas e outros acessórios.
- Possibilidade de unir facilmente aos diferentes produtos Makpac.

Descrição	Unds.	Código	EAN	P.V.P. (€)
4 Gavetas. 295 x 395 x 210 mm	1	P-84311	0088381580786	195,00
6 Gavetas. 295 x 395 x 210 mm	1	P-84333	0088381580809	223,00
12 Gavetas. 295 x 395 x 210 mm	1	P-84327	0088381580793	231,00

### Conjunto de divisórias para malas Makpac



P-84171

191X92-5

191X80-2

Descrição	Unds.	Código	EAN	P.V.P. (€)
Caixa organizadora Makpac	1	191X80-2	0088381589987	68,00
Conjunto de caixas	1	191X92-5	-	14,00
Conjunto de caixas	1	P-84171	0088381536035	15,40

## Geleira Makpac

Ótimo para manter as bebidas frias no local de trabalho!

- Com espessura de 20 mm de poliestireno, e tiras de vedação na junção entre a tampa e a caixa.

18L



500mL x 20    2L x 4

Dimensões	Mala	Unds.	Código	EAN	P.V.P. (€)
295 x 395 x 315mm	Tipo 4	1	198253-4	0088381476607	128,00

## Carro de transporte



Descrição	Unds.	Código	EAN	P.V.P. (€)
Carrinho de transporte Suporta até 100 kg de carga	1	P-83886	0088381468411	128,00

## Trolley com rodas



Mala Makpac não incluída

Descrição	Unds.	Código	EAN	P.V.P. (€)
Trolley com rodas Suporta até 25 kg de carga	1	TR00000001	0088381468190	228,00

## Separador de plástico interior

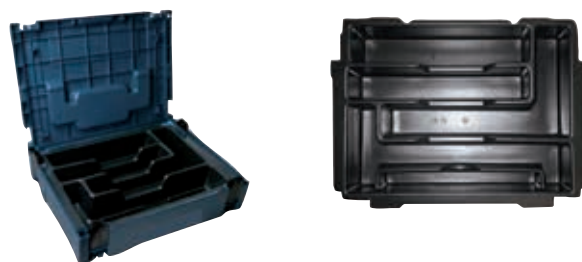

Mala Makpac não incluída

Descrição	Unds.	Código	EAN	P.V.P. (€)
Separador com diferentes compartimentos	1	P-83668	0088381463805	11,60

## Separador de cores em plástico interior

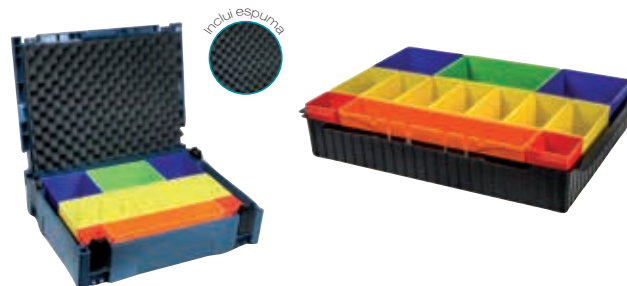

Mala Makpac não incluída

Descrição	Unds.	Código	EAN	P.V.P. (€)
Separador com diferentes compartimentos	1	P-83652	0088381463799	34,00

## Separador de espuma

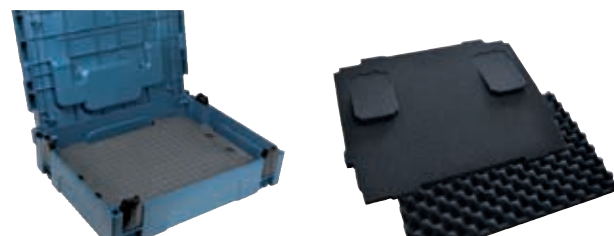

Mala Makpac não incluída

P-84268

Descrição	Unds.	Código	EAN	P.V.P. (€)
Separador de espuma para todas as malas Makpac	1	P-83705	0088381463843	24,00
Espuma 20mm universal makpac	1	P-84268	-	17,80
Espuma 40mm universal makpac	1	P-84274	-	21,00

## Caixa de ferramentas Makpac



Descrição	Unds.	Código	EAN	P.V.P. (€)
Caixa de ferramentas prática com vários compartimentos	1	P-84137	0088381524865	95,00



## Plásticos interiores e malas MAKPAC

### Tipo 1



Medidas	Unds.	Código	EAN	P.V.P. (€)
39,5 x 29,5 x 10,5 cm	1	821549-5	0088381432986	33,00

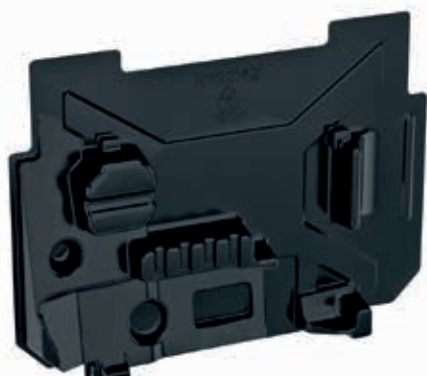

Modelo	Makpac	Unds.	Código	EAN	P.V.P. (€)
3709	821550-0	1	837674-2	0088381525923	9,40
3710	821550-0	1	837674-2	0088381525923	9,40
4326	821549-5	1	837803-7	0088381436090	8,20
4328	821549-5	1	837803-7	0088381436090	8,20
4329	821549-5	1	837803-7	0088381436090	8,20
6906	821550-0	1	838024-4	0088381436090	11,30
6952	821549-5	1	837869-7	-	8,50
9046	821550-0	1	838025-2	0088381525978	11,30
9403	821551-8	1	837652-2	-	8,80
9404	821551-8	1	837653-0	0088381436359	8,80
9910	821551-8	1	837658-0	0088381436366	8,20
9911	821551-8	1	837658-0	0088381436397	8,20
4350CT	821549-5	1	837803-7	0088381436397	8,20
4350FCT	821549-5	1	837803-7	0088381436090	8,20
4351FCT	821549-5	1	837803-7	0088381436090	8,20
5008MG	821552-6	1	837657-2	0088381436090	10,30
5604R	821552-6	1	837657-2	0088381436489	10,30
5704R	821552-6	1	837657-2	0088381436489	10,30
6904V	821549-5	1	837869-7	0088381436489	8,50
BO4900V	821550-0	1	837675-0	0088381525978	9,00
BO4901	821550-0	1	837675-0	0088381436212	9,00
BO5030	821552-6	1	837247-1	0088381436212	8,80
BO5031	821552-6	1	837247-1	0088381436441	8,80
BO5040	821552-6	1	837247-1	0088381526029	8,80
BO5041	821552-6	1	837247-1	0088381436441	8,80
BO6030	821551-8	1	837654-8	0088381526029	9,30
BO6040	821551-8	1	837655-6	0088381436441	9,00
BO6050J	821551-8	1	838246-6	0088381526029	5,90

### Tipo 2



Medidas	Unds.	Código	EAN	P.V.P. (€)
39,5 x 29,5 x 15,5 cm	1	821550-0	0088381430128	36,00



Modelo	Makpac	Unds.	Código	EAN	P.V.P. (€)
BST221	821550-0	1	837640-9	0088381436441	10,00
CA5000	821552-6	1	838390-9	0088381526029	10,60
CC301	821552-6	1	838315-3	0088381436373	7,30
DA330D	821549-5	1	837695-4	0088381436380	10,20
DBN500	821551-8	1	838023-6	0088381526142	7,90
DBN600	821552-6	1	839523-9	0088381436137	4,70
DBO180	821550-0	1	837809-5	0088381526197	8,20
DBO380	821551-8	1	8351P0-7	0088381525978	5,00
DBO381	821551-8	1	8351P0-7	0088381525985	5,00
DBO382	821551-8	1	8351P0-7	0088381525954	5,00
DBS180	821550-0	1	835P86-9	0088381526180	4,50
DCC501	821551-8	1	835U78-8	0088381436083	3,00
DCS550	821551-8	1	837628-9	0088381453967	9,10
DCS553	821551-8	1	839751-6	0088381526326	5,20
DDA350	821550-0	1	838040-6	0088381437349	7,90
DDF083	821550-0	1	837670-0	-	12,90
DDF343	821550-0	1	837916-4	-	9,70
DDF441	821550-0	1	837916-4	0088381436274	9,70
DDF446	821550-0	1	837916-4	0088381546492	9,70
DDF448	821550-0	1	837916-4	0088381441704	9,70
DDF451	821550-0	1	837916-4	0088381436182	9,70
DDF453	821550-0	1	837916-4	0088381441438	9,70
DDF456	821550-0	1	837916-4	0088381441438	9,70
DDF459	821550-0	1	837916-4	0088381441438	9,70
DDF480	821550-0	1	837916-4	0088381441438	9,70
DDF482	821550-0	1	837916-4	0088381441438	9,70
DDF483	821550-0	1	837670-0	0088381441438	12,90
DDF484	821550-0	1	837916-4	0088381441438	9,70

## Plásticos interiores e malas MAKPAC

### Tipo 3



Medidas	Unds.	Código	EAN	P.V.P. (€)
39,5 x 29,5 x 21,5 cm	1	821551-8	0088381432993	40,00

### Tipo 4



Medidas	Unds.	Código	EAN	P.V.P. (€)
39,5 x 29,5 x 31,5 cm	1	821552-6	0088381433006	51,00



Modelo	Makpac	Unds.	Código	EAN	P.V.P. (€)
DDF485	821550-0	1	837916-4	0088381441438	9,70
DDF486	821550-0	1	837916-4	0088381441438	9,70
DDF487	821550-0	1	837916-4	0088381436182	9,70
DF001G	821551-8	1	835F93-2	0088381441438	3,15
DF030D	821549-5	1	837866-3	0088381441438	8,80
DF031D	821549-5	1	838312-9	0088381441438	7,00
DF032D	821549-5	1	838312-9	0088381436182	7,00
DF033D	821549-5	1	838312-9	0088381441438	7,00
DF330D	821549-5	1	837866-3	-	8,80
DF331D	821549-5	1	838312-9	0088381525954	7,00
DF332D	821549-5	1	838312-9	0088381526166	7,00
DF333D	821549-5	1	838312-9	0088381526166	7,00
DFN350	821550-0	1	835B51-4	0088381526166	4,10
DFR550	821551-8	1	837631-0	0088381525954	8,20
DFS250	821550-0	1	837805-3	0088381526166	8,20
DFS251	821550-0	1	837805-3	0088381526166	8,20
DFS451	821550-0	1	837805-3	0088381526166	8,20
DFS452	821550-0	1	837805-3	0088381568777	8,20
DGA452	821551-8	1	837632-8	0088381447201	8,70
DGA454	821551-8	1	838175-3	0088381436250	10,80
DGA458	821551-8	1	838175-3	0088381436250	10,80
DGA461	821551-8	1	838175-3	0088381436250	10,80
DGA463	821551-8	1	838175-3	0088381436250	10,80
DGA467	821551-8	1	838175-3	0088381436250	10,80
DGA469	821551-8	1	838175-3	0088381436250	10,80
DGA504	821551-8	1	838175-3	0088381436281	10,80
DGA508	821551-8	1	838175-3	0088381453981	10,80
DGA511	821551-8	1	838175-3	0088381453981	10,80

Modelo	Makpac	Unds.	Código	EAN	P.V.P. (€)
DGA513	821551-8	1	838175-3	0088381453981	10,80
DGA517	821551-8	1	838175-3	0088381453981	10,80
DGA519	821551-8	1	838175-3	0088381453981	10,80
DGD800	821550-0	1	837806-1	0088381453981	8,20
DHK180	821552-6	1	835D35-4	0088381453981	4,70
DHP343	821550-0	1	837916-4	0088381453981	9,70
DHP441	821550-0	1	837916-4	0088381453981	9,70
DHP446	821550-0	1	837916-4	0088381453981	9,70
DHP451	821550-0	1	837916-4	0088381574501	9,70
DHP453	821550-0	1	837916-4	0088381441438	9,70
DHP456	821550-0	1	837916-4	0088381441438	9,70
DHP458	821550-0	1	837916-4	0088381436267	9,70
DHP459	821550-0	1	837916-4	0088381441438	9,70
DHP480	821550-0	1	837916-4	0088381441438	9,70
DHP481	821550-0	1	837916-4	0088381441438	9,70
DHP482	821550-0	1	837916-4	0088381441438	9,70
DHP483	821550-0	1	837670-0	0088381441438	12,90
DHP484	821550-0	1	837916-4	0088381441438	9,70
DHP485	821550-0	1	837916-4	0088381441438	9,70
DHP486	821550-0	1	837916-4	0088381441438	9,70
DHR165	821551-8	1	838109-6	0088381441438	9,10
DHR171	821551-8	1	839387-1	0088381441438	5,60
DHR182	821552-6	1	839891-0	0088381441438	5,60
DHR202	821551-8	1	837634-4	0088381436182	9,60
DHR242	821552-6	1	837649-1	0088381441438	8,80
DHR243	821552-6	1	837649-1	0088381453998	8,80
DHR262	821552-6	1	837650-6	0088381535588	9,10
DHR262T	821552-6	1	837650-6	0088381558785	9,10





Modelo	Makpac	Unds.	Código	EAN	P.V.P. (€)
DHR263	821552-6	1	837988-9	0088381436304	10,00
DHR264	821552-6	1	837988-9	0088381535595	10,00
DHR280	821552-6	1	839559-8	0088381535595	4,60
DHR281	821552-6	1	839559-8	0088381436472	4,60
DHR282	821552-6	1	839559-8	0088381436472	4,60
DHR283	821552-6	1	839559-8	0088381454001	4,60
DHS660	821551-8	1	839752-4	0088381546485	5,50
DHS661	821551-8	1	839752-4	0088381454001	5,50
DHS680	821551-8	1	838182-6	0088381526333	10,90
DHS710	821552-6	1	837861-3	0088381526333	18,70
DHS782	821552-6	1	835C85-3	-	4,70
DHS783	821552-6	1	835C85-3	0088381526333	4,70
DJN161	821551-8	1	837678-4	0088381526333	12,80
DJS161	821550-0	1	837636-0	0088381441445	7,60
DJV180	821550-0	1	837639-4	-	12,10
DJV181	821551-8	1	837789-5	0088381436229	7,40
DJV182	821550-0	1	837639-4	0088381447195	12,10
DLX2221	821551-8	1	837864-7	0088381436120	5,80
DP3002	821549-5	1	838039-1	0088381441414	8,70
DP3003	821549-5	1	838039-1	0088381436120	8,70
DP4001	821549-5	1	838039-1	0088381436434	8,70
DP4002	821549-5	1	838039-1	0088381580038	8,70
DP4003	821549-5	1	838039-1	0088381441216	8,70
DP401	821549-5	1	838039-1	0088381441452	8,70
DPJ180	821551-8	1	837648-3	0088381441452	8,20
DPT351	821550-0	1	837640-9	0088381441452	10,00
DPT353	821551-8	1	839128-5	0088381441452	9,00
DSD180	821550-0	1	838542-2	0088381436342	7,00
DSS501	821551-8	1	837628-9	0088381436137	9,10
DSS610	821551-8	1	837642-5	0088381535601	9,60

Modelo	Makpac	Unds.	Código	EAN	P.V.P. (€)
DST221	821550-0	1	837640-9	0088381436137	10,00
DTD129	821550-0	1	837670-0	-	12,90
DTD134	821550-0	1	837670-0	-	12,90
DTD146	821550-0	1	837670-0	0088381535755	12,90
DTD147	821550-0	1	837670-0	0088381436274	12,90
DTD148	821550-0	1	837670-0	0088381436328	12,90
DTD152	821550-0	1	837670-0	0088381436182	12,90
DTD153	821550-0	1	837670-0	0088381436182	12,90
DTD154	821550-0	1	837670-0	0088381436182	12,90
DTD155	821550-0	1	837670-0	0088381436182	12,90
DTD156	821550-0	1	837670-0	0088381436182	12,90
DTD157	821550-0	1	837670-0	0088381436182	12,90
DTD170	821550-0	1	837670-0	0088381436182	12,90
DTD171	821550-0	1	837670-0	0088381436182	12,90
DTD172	821550-0	1	837670-0	0088381436182	12,90
DTL061	821550-0	1	837644-1	0088381436182	9,00
DTM50	821551-8	1	837671-8	0088381436182	8,70
DTM51	821551-8	1	837671-8	0088381436182	8,70
DTM52	821551-8	1	835W93-4	0088381436182	4,30
DTP140	821550-0	1	837670-0	0088381453981	12,90
DTP141	821550-0	1	837670-0	0088381453981	12,90
DTS141	821550-0	1	837670-0	0088381436182	12,90
DTW1001	821551-8	1	837645-9	0088381436182	8,80
DTW1002	821551-8	1	837645-9	0088381436144	8,80
DTW180	821550-0	1	837670-0	0088381436182	12,90
DTW181	821550-0	1	837670-0	0088381436182	12,90
DTW190	821550-0	1	837670-0	0088381436182	12,90
DTW250	821550-0	1	837670-0	0088381436427	12,90
DTW251	821550-0	1	837670-0	0088381436427	12,90
DTW281	821550-0	1	837670-0	0088381795319	12,90

Modelo	Makpac	Unds.	Código	EAN	P.V.P. (€)
DTW285	821550-0	1	837670-0	0088381436182	12,90
DTW300	821550-0	1	835L10-8	0088381436182	4,00
DTW301	821550-0	1	835L10-8	0088381436335	4,00
DTW450	821551-8	1	837645-9	0088381436335	8,80
DTW700	821551-8	1	837645-9	0088381436335	8,80
DTW701	821551-8	1	837645-9	0088381436335	8,80
FS2300	821550-0	1	837805-3	0088381436182	8,20
FS2500	821550-0	1	837805-3	0088381436182	8,20
FS2700	821550-0	1	837805-3	0088381436182	8,20
FS4200	821550-0	1	837805-3	0088381436182	8,20
FS6300	821550-0	1	837805-3	-	8,20
GA005G	821552-6	1	835E79-0	-	3,20
GA008G	821552-6	1	835E79-0	0088381436335	3,20
GA013G	821552-6	1	835E79-0	0088381436250	3,20
GA016G	821552-6	1	835E79-0	0088381436250	3,20
GA022G	821552-6	1	835E79-0	0088381436250	3,20
GA023G	821552-6	1	835E79-0	0088381436250	3,20
GA026G	821552-6	1	835E79-0	0088381436250	3,20
GA028G	821552-6	1	835E79-0	0088381590556	3,20
GA029G	821552-6	1	835E79-0	0088381590556	3,20
GA032G	821552-6	1	835E79-0	0088381590556	3,20
GA4540	821550-0	1	837672-6	0088381436199	4,70
GA4540C	821550-0	1	837672-6	0088381436199	4,70
GA5040	821550-0	1	837672-6	0088381436199	4,70
GA5040C	821550-0	1	837672-6	0088381436199	4,70
HP001G	821551-8	1	835F93-2	-	3,15
HP2051	821549-5	1	838039-1	0088381441452	8,70
HP2071	821549-5	1	838039-1	0088381441452	8,70
HP330D	821549-5	1	837866-3	0088381436199	8,80
HP331D	821549-5	1	838312-9	0088381436199	7,00
HP332D	821549-5	1	838312-9	0088381436199	7,00
HP333D	821549-5	1	838312-9	0088381436199	7,00
HR001G	821552-6	1	835C84-5	-	3,20
HR002G	821552-6	1	835C84-5	0088381441452	3,20
HR003G	821552-6	1	835C84-5	0088381441452	3,20
HR004G	821552-6	1	835C84-5	0088381525954	3,20
HR140D	821550-0	1	839245-1	0088381526166	5,30
HR166D	821550-0	1	838683-4	0088381526166	6,60
HR1841	821549-5	1	839214-2	0088381526166	5,60
HR2300	821550-0	1	837651-4	-	8,70
HR2600	821550-0	1	837651-4	-	8,70
HR2610	821550-0	1	837651-4	-	8,70
HR2610T	821550-0	1	837651-4	-	8,70
HR2611FT	821550-0	1	837651-4	0088381526258	8,70
HS004G	821552-6	1	835K82-7	-	4,10
HS300D	821550-0	1	837662-9	0088381526241	16,30
HS6101	821552-6	1	837807-9	0088381436151	8,60
HS6601	821551-8	1	838314-5	0088381436151	5,20
HS7101	821552-6	1	837807-9	0088381436151	8,60
HS7601	821552-6	1	838108-8	0088381436151	6,00

Modelo	Makpac	Unds.	Código	EAN	P.V.P. (€)
JN3201	821550-0	1	837630-2	0088381436151	9,00
JR100D	821549-5	1	837664-5	-	8,80
JS3201	821550-0	1	837630-2	0088381436175	9,00
JV0600	821549-5	1	837803-7	0088381436502	8,20
JV100D	821549-5	1	837665-3	0088381545280	9,80
JV103D	821549-5	1	839186-1	0088381436502	5,50
Kits baterías 4,0 ah	821552-6	1	839205-3	-	5,60
Kits baterías 5,0 ah	821552-6	1	839205-3	0088381430142	5,60
Kits baterías 6,0 ah	821552-6	1	839205-3	0088381436052	5,60
KP0800	821551-8	1	837659-8	0088381430142	8,20
KP0810	821551-8	1	837659-8	0088381436090	8,20
KP0810C	821551-8	1	837659-8	0088381436069	8,20
N9741	821551-8	1	838026-0	0088381526234	9,40
PJ7000	821551-8	1	837661-1	-	12,30
RP0900	821550-0	1	837646-7	-	8,70
RP0910	821550-0	1	837660-3	-	9,10
RP110C	821550-0	1	837660-3	0088381436403	9,10
RP1800	821552-6	1	837647-5	0088381436403	8,80
RP2300FC	821552-6	1	837647-5	0088381436403	8,80
RT0700C	821552-6	1	837247-1	-	8,80
SA5040C	821550-0	1	837672-6	0088381436410	4,70
SG1251	821552-6	1	838111-9	0088381525916	8,80
SP6000	821552-6	1	837945-7	0088381436168	8,20
TD001G	821551-8	1	835F94-0	0088381436168	3,30
TD090D	821549-5	1	837866-3	0088381436465	8,80
TD110D	821549-5	1	838312-9	0088381436465	7,00
TD111D	821549-5	1	838312-9	0088381436441	7,00
TM3000C	821550-0	1	837673-4	0088381436199	8,70
TM3010C	821550-0	1	837673-4	0088381526135	8,70
TW001G	821551-8	1	835K85-1	0088381437356	5,50
TW004G	821550-0	1	835R29-3	-	4,10
TW005G	821550-0	1	835R29-3	0088381525954	4,10
TW007G	821551-8	1	835K85-1	0088381526166	5,50
TW008G	821551-8	1	835K85-1	0088381526166	5,50
TW0200	821549-5	1	837869-7	0088381436205	8,50
TW0350	821550-0	1	837870-2	0088381436205	8,10
TW100D	821549-5	1	837866-3	-	8,80

## Fecho Mala Makpac



Descrição	Unds.	Código	EAN	P.V.P. (€)
Fecho Mala Makpac	1	453974-8	0088381430135	0,65





Modelo	Descrição	Unds.	Código	EAN	P.V.P. (€)
1100	Metálico	1	181790-5	008838118705	106,00
4326	Plástico	1	824572-9	0088381151627	12,70
4327	Plástico	1	824572-9	0088381151627	12,70
4328	Plástico	1	824572-9	0088381151627	12,70
4329	Plástico	1	824572-9	0088381151627	12,70
6807	Plástico	1	824890-5	3240890391902	16,50
6842	Plástico	1	824808-6	0088381347204	36,00
6844	Plástico	1	824808-6	0088381347204	36,00
2107F	Plástico	1	824728-4	0088381197700	48,00
2107FX	Plástico	1	824728-4	0088381197700	48,00
4350CT	Plástico	1	824809-4	0088381345729	25,00
4350T	Plástico	1	824809-4	0088381345729	25,00
4351CT	Plástico	1	824809-4	0088381345729	25,00
5603R	Plástico	1	824555-9	0088381189422	49,00
5604R	Plástico	1	824555-9	0088381189422	49,00
5903R	Plástico	1	193196-5	0088381189385	62,00
6019D	Plástico	1	824723-4	0088381200455	18,20
6096D	Plástico	1	824723-4	0088381200455	18,20
6207DW	Plástico	1	183763-4	0088381139595	25,00
6260D (3baterías)	Plástico	1	824652-1	0088381196949	10,50
6261D (3baterías)	Plástico	1	824852-3	0088381350631	15,10
6270D (3baterías)	Plástico	1	824652-1	0088381196949	10,50
6271D (3baterías)	Plástico	1	824852-3	0088381350631	15,10
6280D (3baterías)	Plástico	1	824652-1	0088381196949	10,50
6281D (3baterías)	Plástico	1	824852-3	0088381350631	15,10
6317D	Plástico	1	183763-4	0088381139595	25,00
6337D	Plástico	1	183763-4	0088381139595	25,00
6347D	Plástico	1	183763-4	0088381139595	25,00
6391D (3baterías)	Plástico	1	824852-3	0088381350631	15,10
6904V	Plástico	1	824698-7	0088381183789	30,00
6905B	Plástico	1	824698-7	0088381183789	30,00
6905H	Plástico	1	824698-7	0088381183789	30,00
6918FD	Plástico	1	824635-1	0088381161145	11,60
6934FD	Plástico	1	824635-1	0088381161145	11,60
6935FD	Plástico	1	824635-1	0088381161145	11,60
6936FD	Plástico	1	824635-1	0088381161145	11,60
6980FD	Plástico	1	824635-1	0088381161145	11,60
8270D	Plástico	1	824635-1	0088381161145	11,60
8280D	Plástico	1	824635-1	0088381161145	11,60
9554NB	Metálico	1	823256-6	-	26,00
9555NB	Metálico	1	823256-6	-	26,00
9557NB	Metálico	1	823256-6	-	26,00
9558NB	Metálico	1	823256-6	-	26,00
AF505	Plástico	1	HY00000090	0088381335218	21,00
BFR440	Plástico	1	824756-9	0088381341981	24,00
BGA452	Plástico	1	824767-4	0088381289702	21,00
BHR162	Plástico	1	824863-8	0088381351010	57,00
BHR200SJEP	Plástico	1	824690-3	-	39,00
BHR202	Plástico	1	141642-2	-	26,00
BJR181	Plástico	1	824760-8	0088381341998	25,00
BO4556	Plástico	1	824806-0	0088381346092	14,50
BO4565	Plástico	1	824806-0	0088381346092	14,50

Modelo	Descrição	Unds.	Código	EAN	P.V.P. (€)
BO5020	Plástico	1	183782-0	0088381189262	25,00
BO5021	Plástico	1	183782-0	0088381189262	25,00
BO5030	Plástico	1	183782-0	0088381189262	25,00
BO5031	Plástico	1	183782-0	0088381189262	25,00
BSS610	Plástico	1	824757-7	0088381252898	32,00
BTW200	Plástico	1	824593-1	0088381158084	37,00
BUK122	Plástico	1	824820-6	3240890258571	50,00
DA4000LR	Plástico	1	824646-6	0088381171052	47,00
DBM080	Metálico	1	P-45135	0088381975247	50,00
DBN500	Metálico	1	821604-3	-	60,00
DF010D	Plástico	1	158775-6	3240890276278	12,40
DF030D	Plástico	1	824842-6	3240890276261	12,30
DF330D	Plástico	1	824842-6	3240890276261	12,30
DF347D	Plástico	1	824981-2	0088381401517	20,00
DF457D	Plástico	1	824981-2	0088381401517	20,00
DGP180	Plástico	1	821840-1	-	44,00
DP4011	Plástico	1	824695-3	0088381184342	16,50
FS2300	Plástico	1	824890-5	3240890391902	16,50
FS2500	Plástico	1	824890-5	3240890391902	16,50
FS2700	Plástico	1	824890-5	3240890391902	16,50
FS4200	Plástico	1	824890-5	3240890391902	16,50
FS6300R	Plástico	1	824890-5	3240890391902	16,50
GA038G	Plástico	1	821841-9	-	56,00
GA7020R	Plástico	1	824958-7	0088381371438	31,00
GA7030R	Plástico	1	824958-7	0088381371438	31,00
GA7040R	Plástico	1	824958-7	0088381371438	31,00
GA9020R	Plástico	1	824958-7	0088381371438	31,00
GA9030R	Plástico	1	824958-7	0088381371438	31,00
GA9040R	Plástico	1	824958-7	0088381371438	31,00
GF600SE	-	-	824990-1	0088381425148	62,00
GN900SE	Plástico	1	824875-1	0088381354509	54,00
HG5002	Plástico	1	HG130442	3240890345578	24,00
HG5012	Plástico	1	HG130442	3240890345578	24,00
HG550V	Plástico	1	HG130442	3240890345578	24,00
HG551V	Plástico	1	HG130442	3240890345578	24,00
HG651C	Plástico	1	HG130442	3240890345578	24,00
HK0500	Plástico	1	824523-2	0088381151849	43,00
HK1810	Metálico	1	150640-5	0088381152426	37,00
HK1820	Plástico	1	824789-4	0088381346108	19,00
HM0860C	Plástico	1	824708-0	0088381187725	42,00
HM0870C	Plástico	1	824905-8	-	76,00
HM0871C	Plástico	1	824904-0	0088381361743	79,00
HM1101C	Plástico	1	140561-9	0088381367639	141,00
HM1111C	Plástico	1	140561-9	0088381367639	141,00
HM1200K	Plástico	1	150583-1	0088381152402	50,00
HM1202C	Plástico	1	824564-8	0088381154536	74,00
HM1203C	Plástico	1	824908-2	0088381359504	109,00
HM1213C	Plástico	1	824908-2	0088381359504	109,00
HM1214C	Plástico	1	824882-4	0088381359788	156,00
HM1303	Metálico	1	182851-4	0088381155618	158,00
HM1304B	Metálico	1	183598-3	0088381183796	112,00
HM1307C	Plástico	1	824898-9	-	152,00



Modelo	Descrição	Unds.	Código	EAN	P.V.P. (€)
HM1317C	Plástico	1	824898-9	-	152,00
HM1317CB	Plástico	1	824898-9	-	152,00
HM1511	Plástico	1	821836-2	-	95,00
HP1620	Plástico	1	824724-2	0088381193887	19,30
HP1621	Plástico	1	824724-2	0088381193887	19,30
HP1631	Plástico	1	824811-7	0088381351140	25,00
HP1640	Plástico	1	824811-7	0088381351140	25,00
HP1641	Plástico	1	824811-7	0088381351140	25,00
HP2050	Plástico	1	824695-3	3240890275165	16,50
HP2051	Plástico	1	824695-3	3240890275165	16,50
HP2070	Plástico	1	824695-3	3240890275165	16,50
HP2071	Plástico	1	824695-3	3240890275165	16,50
HP330D	Plástico	1	824842-6	3240890276261	12,30
HP347D	Plástico	1	824981-2	0088381401517	20,00
HP457D	Plástico	1	824981-2	0088381401517	20,00
HR005G	Plástico	1	821837-0	-	46,00
HR160D	Plástico	1	824550-9	0088381157612	22,00
HR1830	Plástico	1	824695-3	3240890275165	16,50
HR2020	Plástico	1	824695-3	3240890275165	16,50
HR2230	Plástico	1	824799-1	0088381346849	27,00
HR2440	Plástico	1	824695-3	3240890275165	16,50
HR2450	Plástico	1	824695-3	3240890275165	16,50
HR2460	Plástico	1	824799-1	0088381346849	27,00
HR2470	Plástico	1	824799-1	0088381346849	27,00
HR2631FT	Plástico	1	824915-5	-	31,00
HR2800	Plástico	1	824789-4	0088381346108	19,00
HR2810	Plástico	1	824789-4	0088381346108	19,00
HR2811	Plástico	1	824789-4	0088381346108	19,00
HR3200C	Plástico	1	824819-1	3240890266422	59,00
HR3210C	Plástico	1	824825-6	0088381349727	68,00
HR3540C	Plástico	1	824819-1	3240890266422	59,00
HR3541FC	Plástico	1	824825-6	0088381349727	68,00
HR4013C	Plástico	1	196278-2	0088381462976	105,00
HR4500C	Plástico	1	824607-6	0088381160070	67,00
HR4501C	Plástico	1	158274-8	0088381369510	81,00
HR5000	Plástico	1	150589-9	0088381146661	62,00
HR5001C	Plástico	1	824519-3	0088381152952	68,00
HR5201C	Plástico	1	158274-8	3240890306630	81,00
JR001G	Plástico	1	821796-8	0088381579797	40,00
JR3060T	Plástico	1	821621-3	-	25,00
JR3070CT	Plástico	1	821621-3	-	25,00
JV0600K	Plástico	1	824998-5	0088381401487	22,00
KP0800	Plástico	1	824892-1	0088381361408	22,00
PC1100	Metálico	1	181789-0	0088381116213	75,00
PC5001C	Metálico	1	140073-2	0088381358651	77,00
SG150	Metálico	1	B50856	3240890267061	68,00
TD090D	Plástico	1	824842-6	3240890276261	12,30
TW0200	Plástico	1	824703-0	0088381185424	16,20
TW0350	Plástico	1	824702-2	0088381185837	21,00
TW1000	Plástico	1	824737-3	0088381200042	60,00
UC120DWAE	Plástico	1	824491-9	0088381152747	40,00
JV101	Plástico	1	821691-2	-	22,00

Modelo	Descrição	Unds.	Código	EAN	P.V.P. (€)
HR4001	Plástico	1	196183-3	-	100,00
HR4011C	Plástico	1	196185-9	-	106,00
DTM51	Plástico	1	821608-5	-	25,00
BHP458	Plástico	1	143603-8	-	39,00
HS7101	Plástico	1	141736-3	-	61,00
TD110D	Plástico	1	821661-1	-	17,90
DJR187	Plástico	1	821620-5	0088381572385	31,00
DJR181	Plástico	1	141354-7	-	31,00
HS301D	Plástico	1	821663-7	-	22,00
DCG180	Plástico	1	821568-1	0088381437516	67,00
DGA900	Plástico	1	821717-0	0088381536172	62,00
DGA511	Plástico	1	821734-0	-	39,00
CG100	Plástico	1	821710-4	0088381585927	34,00
DJR360	Plástico	1	821670-0	0088381524209	55,00
9069K1	Plástico	1	824707-2	-	16,50
BHR242	Plástico	1	141401-4	0088381432764	32,00



Escovas (por modelos de máquina)

1	6319D			BPJ180		DTW450	441	HP1631K	419	LF1016F	
1100	100	6337D	430	BSS501	430	F		HP2010N	106	LH1040F	153
1902	51	6339D		BSS610	441	FS2300		HP2033		LH1200FL	
1806B	153	6347D		BTD130F	440	FS2500	419	HP2050	419	LS0714F	303
1902K		6349D		BTD140	440	FS2700		HP2051		LS0815FL	JM23500117
1923B	51	6501X		BTD200	441	FS4200		HP2070		LS1013F	
1923H	132	6797F	BTP130	440	FS6300R	HP2071		LS1013FL			
2	6805BV		64	BTP140	440	G	HR1830		LS1013L		
2012NB	153	6824N	419	BTS130	440	GA4530	HR2020	325	LS1016FL	153	
2107FK	303	6825R		BTW200	441	GA5030	HR2230		LS1018L		
2107FKX		6826N		BTW250	440	GA4534	HR2300		LS1040F		
2414B		6904V		BTW251	440	GA5034	HR2410		LS1214F		
2414EN	203	6905B		BTW450	441	GA4540C	318*		HR2432		LS1214L
2414NB		6905H	415	BUC122	430	GA4540Z	325	HR2440	LS1216F		
2704	153	6918FD	434	D		GA5021C	253	HR2450	LS1216FL		
		6932FD		DA3000R	65	GA5040C	318*	HR2450T	LS1440		
3612	203	6934FD		DA3010F	419	GA5040Z	325	HR2460	M		
3620	106	6935FD		DA3011F		GA6021C	253	HR2460F	MLS100	JM23000123	
3706	64	6936FD		DA4000LR	303	GA6040C	318*	HR2470	MLT100		
3709		6980FD	DA4031		GA7010C		HR2470F	N			
3710	411	7	DA6301	100	GA7012C	204*	HR2470FT	N4105KB	100		
3901		7104L	DBM130		GA7020S		HR2510	N9741			
3601B	153	8	DBM131	EE80700019	GA7020R		HR2600	NPC1100			
3612C	203	8414D	DBM230		GA7030S		HR2610	P			
3707FC	411	8434D	DCS550	430	GA7030R		HR2610T	PC5001C	253		
		8444D	DDA340		GA7040S		HR2611FT	PJ7000C	459		
440	80051B5X	9	DDF440		GA7040R		HR262D	PV7000C	303		
443	W26774	906	DDF441	64	GA7050		HR262TD	PW5000CH	318*		
445X	80051B5X	9031	DDF442	411	GA7050R		HR2800	R			
446L	W49625	9032	DDF450		GA9010C	204*	HR2810	RP0900	106		
447L		9046	DDF451	419	GA9012C			HR2810T	RP0910	303	
4131	303	9402	DDF452	153	GA9020S			HR2811FT	RP1100C		
4326		9403	DDF458	440	GA9020R			HR3000C	RP1800	203	
4327	64	9404	DFR440	303	GA9030S		HR3200C	RP2300FC			
4328		9903	DFR550		GA9030R		HR3210C	RT0700C	411		
4329		9910	DFR750	411	GA9040S		HR3210FCT	S			
4402		9911	DFS440		GA9040R		HR3540C	SA5040C	318*		
4403	411	9920	DFS450		GA9050		HR3541FC	SA7000C	204*		
4101RH	303	9015B	DFS451	303	GA9050R		HR4000C	SC161D	430		
4112HS	204*	9016B	DGA452	430	GD0600	325	HR4001C	SG1250	318*		
4114S		9049S	DGD800		GD0601			HR4003C	SG1251J		
4157KB	153	9059S	DHP440	204*	GD0602		HR4011C	SG150	B45872		
4329K	64	9077S	DHP441		GD0800C		HR4013C	SL7000	MO1401045		
4331D		9079S	DHP442		GD0801C	318*	HR4500C	SP6000	303		
4333D	430	9218BS	DHP450	100	GD0810C			HR4501C	SR2300	155*	
4334D	441	9227CB	DHP451	303	GD0811C		HR4511C	T			
4340CT		9554NB	DHP452		GS5000	204*	HR5000	TD0101F	411		
4350CT		9555NB	DHP458		GS6000		HR5001C	TM3000C	459		
4350FCT		9557NB	DHP460	325	GV5010	64	HR5201C	TM3010C			
4350T	419	9558NB	DHR162	430	GV7000C	303	HR5202C	TW0200	411		
4351CT		9558PBY	DHR200		H		HR5211C	TW0350			
4351FCT		9561CH	DHR202	441	HB500	EIB106C	HR5212C	TW1000	153		
		9562C	DHR261		HK0500	113	HS6100	U			
5008MG	153	9562CH	DHR262	442	HK1810	105*	HS7100	UB1101	303		
5017RKB	303	9562CVH	DJN161	430	HK1820	350*	HS7101	UC3530A	957805410		
5103R		9564C	DJR181		HM0810B		J	UC4020A	132		
5104S	203	9564H	DJR182	441	HM0810T	105*	JN1601	UC4030A	957805410		
5143R		9565CV	DJR240		HM0830T		JN3200	UT120	EE80700013		
5603R		9565CVL	DJV140	430	HM0860C	327*	JN3201	UT121	EE80700032		
5604R		9565H	DJV180		HM0870C		JR1000FT	SG150	B45872		
5704R	303	9565PCV	DDF446		HM0871C	350*	JR140D	SP6000	303		
5705R		9566C	DDF458	440	HM1101C		JR180D	SR2300	155*		
5903R	203	9566CV	DFS451		HM1111C	171	JR3050T	T			
		9566PCV	DGA452	430	HM1200B		JR3060T	TM3000C	459		
6305	303	9924DB	DHP456	440	HM1200K	155*	JR3070CT	TM3010C			
6310		B	DHP458		HM1202C		JS1000	TW0200			
6408	419	BLS820	DHR202	441	HM1203C		JS1600	TW0350	411		
6413	64	BO3700	DJR181	441	HM1213C	171	JS1601	TW1000	153		
6501	70	BO4556	DJV180	430	HM1214C		JS1602	U			
6807		BO4557	DP2010		HM1304	204*	JS1660	UB1101	303		
6821		BO4565	DP2011		HM1304B			JS1670	UC3530A	957805410	
6823	419	BO4566	DP3002		HM1307C		JS3200	UC4020A	132		
6824		BO4900V	DP3003		HM1317C	171	JS3201	UC4030A			
6826		BO4901	DP4000	419	HM1317CB		JS8000	UH5540	957805410		
6827		BO5010	DP4001		HM1400	155*	JV0600	UH6540			
6842	411	BO5020	DP4002	64	HM1801		K	UT120	EE80700013		
6844		BO5021	DP4003		HM1810	204*	KP0800	UT1200	EE80700032		
6906	100	BO5030	DP4011		HP1620		KP0810				
6952	411	BO5031	DS4012	411	HP1621	419	KP0810C		132		
6013B		BO5040	DP4700	64	HP1631	85	KP312S		203		
6300-4	51	BO5041	DS4010	411	HP1640		L				
6305W	303	BO6030	DTD146	419	HP1641	419	LC1230		203		
6317D	430	BO6040	DTW251	440	HP1641K		LF1000		153		

## Escovas (por modelo de escova)

Modelo	Código	Nome	Modelo	Código	Nome	Modelo	Código	Nome	Modelo	Código	Nome	Modelo	Código	Nome	Modelo	Código	Nome					
51	1902	HM1200B	155*	4101RH	303	325	HR2810T	419	DP4003	440	DFR750	64	3706	HM1101C	303	5017RKB	325	HR2811FT	419	DP4011	440	DFS440
	1902K	HM1200K		5603R		HR2811FT	DP4011		DFS440													
	1923B	HM1202C		5604R		HM0830T	FS2300		DFS450													
	6013B	HM1400		5704R		HM0860C	FS2500		DFS451													
	6300-4	HR4500C		5705R		HR3000C	FS2700		DHP440													
64	4326	HR5000	171	6305	303	327*	HR4000C	419	FS4200	440	DHP441	64	4327	HM1101C	303	6305W	325	HR4000C	419	FS4200	440	DHP442
	4328	HM1111C		9403		HR4000C	FS6300R		DHP442													
	4329	HM1111C		9404		HM0870C	HP1620		DHP450													
	4329K	HM1203C		9903		HM0871C	HP1621		DHP451													
	6413	HM1213C		9920		HR3200C	HP1640		DHP452													
	6805BV	HM1214C		9015B		HR3210C	HP1641		DHP458													
	906	HM1307C		9016B		HR3210FCT	HP1641K		DDF446													
	BO3700	HM1317C		9227CB		HR3540C	HP1631K		DDF458													
	BO5010	HM1317CB		DA4000LR		HR3541FC	HP2033		DFS451													
	BO5020	HR4501C		DA4031		HR4001C	HP2050		DHP456													
	BO5021	HR4511C		GV7000C		HR4003C	HP2051		DHP458													
	BO5040	HR5201C		JN3201		HR4011C	HP2070		DTD146													
	BO5041	HR5211C		JR3050T		HR4013C	HP2071		DTW251													
	DP4700	HS6100		JR3060T		HR4013C	HP2071		DTW251													
	GV5010	HS7100		JR3070CT		3709	HR1830		4334D													
JV0600	HS7101	JS3201	3710	HR2020	BLS820																	
65	6905B	HR5202C	174	JS3201	303	411	3709	419	HR2410	440	BSS610	64	6905B	HR5202C	303	4402	325	HR2410	419	HR2410	440	BTD200
	DA3000R	HR5212C		LS0714F		3901	HR2432		BTW200													
	JS1600	2414B		PV7000C		3707FC	HR2440		BTW450													
	JS1660	2414EN		RP0910		4402	HR2450		DHR202													
	JS1670	2414NB		RP1100C		4403	HR2450T		DJR181													
70	6501	3612	175	SP6000	303	415	6842	419	HR2450T	440	DJR182	64	6501	3612	175	6844	325	HR2450T	419	DJR182		
	6501X	5103R		RP0910		6844	JR1000FT		DJR240													
	HP1631	5104S		RP1100C		6952	JS8000		DHR202													
	1100	5143R		SP6000		9031	JS8000		DJR181													
	6906	5903R		UB1101		9032	4331D		DTW450													
100	9218SB	5143R	203	9561CH	318*	419	9911	419	4331D	440	JR140D	64	9218SB	5903R	203	9562CH	318*	9911	325	6317D	419	JR180D
	9924DB	5903R		9562CVH		DS4012	6319D		DHR261													
	DA6301	KP312S		9564C		DS4010	6339D		DHR262													
	JN3200	LC1230		9565CV		JN1601	6347D		HR262D													
	JS3200	RP1800		9565CVL		KP0800	6349D		HR262TD													
	N4105KB	RP2300FC		9565PCV		RT0700C	8414D		GA4530													
	N9741	4112HS		9566C		TD0101F	8434D		GA5030													
	NPC1100	4114S		9566CV		TW0200	8444D		GA4534													
	HK1810	9049S		9566PCV		TW0350	8444D		GA5034													
	HM0810B	9059S		B06040		6904V	BPJ180		JS1000													
HM0810T	9077S	GA4540C	6905H	BUC122	JS1601																	
105*	HR2510	9079S	318*	GA5040C	318*	415	4340CT	419	DCSS550	440	JS1602	64	HR2510	GA7010C	203	GA4540C	318*	4350CT	325	DGA452	419	PJ7000C
	3620	GA7012C		GA5040C		4350FCT	DGA452		TM3000C													
	HP2010N	GA7020S		GA6040C		4350T	DGD800		TM3010C													
	RP0900	GA7020R		GD0801C		4351CT	DHR162		UC3530A													
	HK0500	GA7030S		GD0810C		4351FCT	DHR200		UC4030A													
132	1923H	GA7030R	318*	PW5000CH	318*	419	6310	419	DHR200	440	EE80700013	64	1923H	GA7030R	203	SA5040C	318*	6408	325	DJN161	419	EE80700019
	KP0810	GA7040S		SG1250		6408	DJN161		DBM130													
	KP0810C	GA7040R		SG1251J		6807	DJV140		DBM131													
	UC4020A	GA7050		5554NB		6821	DJV180		DBM230													
	1806B	GA7050R		9555NB		6823	DGA452		UT120													
	2012NB	GA9010C		9557NB		6824	DJV180		SC161D													
	2704	GA9012C		9558NB		6825	DGA452		SC161D													
	3601B	GA9020S		9558PBY		6826	DJV180		SC161D													
	4157KB	GA9020R		9564H		6826	DGA452		SC161D													
	5008MG	GA9030S		9565H		6827	DJV180		SC161D													
7104L	GA9030R	GA4540Z	6827	DGA452	SC161D																	
153	9402	GA9040S	325	GA5040Z	325	419	6827	419	6918FD	440	EE80700019	64	9402	GA9040S	203	GA5040Z	325	6827	325	6918FD	419	EE80700019
	LF1000	GA9040R		GD0600		6827	6918FD		DBM131													
	LF1016F	GA9050		GD0601		6828	6932FD		DBM230													
	LH1040F	GA9050R		GD0602		6828	6934FD		UT121													
	LH1200FL	GS5000		HR2230		6829	6935FD		UT1200													
	LS1013F	GS6000		HR2300		6829	6936FD		HB500													
	LS1013FL	HM1304		HR2460		9046	6936FD		HB500													
	LS1013L	HM1304B		HR2460F		BO4556	6980FD		MLS100													
	LS1016FL	HM1801		HR2470		BO4557	BTD130F		MLT100													
	LS1018L	HM1810		HR2470F		BO4565	BTD140		LS0815FL													
	LS1040F	SA7000C		HR2470FT		BO4566	BTP130		SL7000													
	LS1214F	GA5021C		HR2600		BO4900V	BTP140		W26774													
	LS1214L	GA6021C		HR2610		BO4901	BTS130		446L													
	LS1216F	PC5001C		HR2610T		BO5030	BTW250		447L													
	LS1216FL	2107FK		HR2611FT		BO5031	BTW251															
LS1440	2107FKK	HR2800	BO6030	DDA340																		
TW1000	4131	HR2810	DA3010F	DDF440																		

Nome	Código	P.V.P. (€)	Nome	Código	P.V.P. (€)	Nome	Código	P.V.P. (€)	Nome	Código	P.V.P. (€)	Nome	Código	P.V.P. (€)
CB-51	181021-2	1,70	CB-113	191904-8	6,10	CB-303	191963-2	3,40	CB-424	191966-6	2,10	957800410	957800410	7,60
CB-64	191627-8	1,70	CB-132	191972-1	4,00	CB-318*	191978-9	8,95	CB-432	191976-3	4,00	957802410	957802410	7,30
CB-65	191628-6	3,40	CB-153	181044-0	3,40	CB-325	194074-2	1,60	CB-434	191971-3	2,65	B45872	B45872	10,15
CB-70	191914-5	2,65	CB-155*	181048-2	7,80	CB-327*	194285-9	4,75	CB-436	193466-2	2,55	EE80700013	EE80700013	7,00
CB-85	191998-3	1,70	CB-171	195844-2	4,00	CB-350*	194160-9	4,00	CB-440	194427-5	3,40	EE80700019	EE80700019	7,00
CB-100	181030-1	2,65	CB-203	191953-5	3,40	CB-411	191940-4	2,25	CB-441	194435-6	4,00	JM23000123	JM23000123	3,40
CB-105*	181038-5	6,10	CB-204*	191957-7	3,40	CB-415	191950-1	5,40	CB-459	194722-3	2,10	W49625	W49625	27,85
CB-106	181410-1	3,10	CB-253	194547-5	4,75	CB-419	191962-4	2,00	80051B5X	80051B5X	13,40			

\* Autodesconectantes.



## Kits de manutenção para martelos



Modelos	Unds.	Código	EAN	P.V.P. (€)
DHR162	1	188580-7	0088381350662	9,00
DHR200	1	195258-5	-	14,50
DHR202	1	195193-7	-	7,80
DHR242 DHR281 DHR282	1	195833-7	-	9,45
DHR243	1	195834-5	-	10,00
BHR261 BHR262 DHR263 DHR264	1	195189-8	-	13,35
HK0500	1	193397-5	-	18,90
HK1810	1	193394-1	-	14,50
HK1820	1	195194-5	-	18,90
HM0810 HM0810T	1	193242-4	-	31,20
HM0830T	1	188048-3	-	21,15
HM0860C	1	195204-8	-	34,65
HM0870C HM0871C	1	195113-1	-	31,20
HM1100 HM1100C	1	193243-2	-	23,45
HM1101C HM1111C	1	195260-8	-	35,70
HM1200 HM1200B	1	193244-0	-	40,95
HM1200K	1	193279-1	-	37,80
HM1202C	1	193391-7	0088381162326	31,20
HM1203C HM1213C HM1214C	1	195114-9	-	37,80
HM1303 HM1303B	1	193393-3	0088381162166	27,85
HM1304 HM1304B	1	195201-4	-	31,20
HM1307C HM1307CB HM1317C	1	195103-4	-	18,90
HM1400	1	193399-1	0088381162210	53,55
HM1801 HM1810	1	195205-6	-	37,80
HM1812	1	197127-6	-	34,65
HR1830	1	188389-7	-	11,15
HR2010	1	193395-9	-	14,50

Modelos	Unds.	Código	EAN	P.V.P. (€)
HR2020 HR2021 HR2432 HR2440 HR2450 HR2450T HR2450FT	1	193606-2	-	18,90
HR2300 HR2600 HR2610	1	195105-0	-	16,70
HR2400	1	193386-0	-	15,55
HR2410 HR2430 HR2431	1	193388-6	-	13,35
HR2230 HR2460 HR2470/T HR2800 HR2810/T HR2811FT	1	195206-4	-	12,30
HR2510	1	193404-4	-	14,50
HR2630	1	196968-7	-	12,30
HR3000C	1	193390-9	0088381162159	23,45
HR3200C HR3210C HR3210FCT	1	195199-5	-	18,90
HR3520 HR3520T	1	193280-6	-	31,20
HR3540C	1	188646-3	-	12,30
HR3850 HR3850B	1	193281-4	-	34,65
HR3850K	1	193282-2	-	40,95
HR4000C	1	193283-0	-	25,70
HR4001C HR4011C	1	195195-3	-	25,65
HR4003C HR4013C	1	196532-4	-	26,70
HR4500C	1	193407-8	0088381162289	25,65
HR4501C HR4511C	1	195210-3	-	27,85
HR5000	1	193284-8	-	23,45
HR5000K	1	193285-6	-	31,20
HR5001C	1	193392-5	0088381163323	31,20
HR5201C HR5211C	1	195191-1	-	27,85
HR5202C HR5212C	1	191K75-7	-	47,00



Código	Pag	P.V.P.	Código	Pag	P.V.P.	Código	Pag	P.V.P.	Código	Pag	P.V.P.	Código	Pag	P.V.P.
501035	119	27,00	122446-1	244	29,00	123241-2	317	8,70	135209-6	88	22,00	168349-5	116	26,00
501036	119	11,00	122464-9	144	18,70	123245-4	334	5,80	135222-4	206	4,90	1911A1-3	331	55,00
501037	119	4,70	122470-4	245	91,00	123245-4	316	5,80	135222-4	317	4,90	168395-8	331	55,00
501038	119	5,00	122472-0	245	5,50	123246-2	334	13,50	135246-0	206	5,00	168395-8	331	55,00
501043	119	198,00	122474-6	281	7,60	123246-2	316	13,50	135269-8	88	42,00	168557-8*	206	2,65
501329	118	36,00	122538-6	245	20,00	123257-7	88	14,00	135283-4	88	41,00	16L	101	36,00
501353	119	173,00	122548-3	208	5,80	123488-8	312	11,00	135302-6	88	4,00	16S	101	26,00
502024	75	39,00	122548-3	317	5,80	123539-7	312	11,00	135327-0	206	6,60	17L	101	37,00
502026	75	49,00	122562-9	208	14,10	123544-4	286	35,00	135332-7	88	24,00	17S	101	26,00
369224790	343	2,80	122562-9	317	14,10	125052-1	183	12,10	135380-6	88	25,00	181434-7	280	1,35
369224791	343	11,60	122562-9	317	14,10	125157-7	207	63,00	13L	101	33,00	181434-7	293	1,35
369224792	343	3,60	122567-9	245	44,00	125158-5	207	35,00	13S	101	24,00	181575-9	312	8,60
369224793	343	11,80	122571-8	245	23,00	125159-3	207	105,00	140441-9	196	4,75	181575-9	316	8,60
369224794	343	31,00	122591-2	208	12,70	125354-5	324	139,85	140830-8	336	62,00	182470-6	349	1,50
369224795	343	4,10	122591-2	317	12,70	125420-8	83	59,00	140G04-3	312	8,25	183477-5	83	4,10
369224796	343	11,80	122652-8	312	2,50	126331-0	312	3,50	140G19-0	312	22,00	183P96-3	335	10,00
369224797	343	31,00	122700-3	286	18,70	126617-2	245	30,00	140G26-3	312	9,80	183P97-1	335	11,00
369224798	343	5,20	122703-7	286	6,00	126738-0	189	6,40	140G26-3	315	9,80	183R02-0	335	7,00
369224799	343	14,10	122707-9	245	17,20	126738-0	317	6,40	140H94-2	312	4,00	18L	101	40,00
369224800	343	35,00	122708-7	85	9,00	126756-8	312	9,00	140H95-0	312	5,50	18S	101	26,00
369224801	343	56,00	122727-3	144	22,00	126756-8	315	9,00	140J64-3	312	8,10	1910C2-9	47	326,00
369224802	343	5,80	122728-1	245	17,70	126882-3	88	16,40	140K23-3	312	2,00	1910C4-5	47	310,00
369224803	343	14,10	122729-9	245	29,00	127069-0	245	49,00	140Y22-9	189	8,50	1910C7-9	312	16,00
369224804	343	36,00	122730-4	245	16,50	127093-3	312	11,60	140Y23-7	189	7,40	1910C9-5	312	18,00
369224805	343	56,00	122739-6	245	124,00	127093-3	315	11,60	140Y25-3	189	3,90	1910D5-0	312	-
369224807	343	2,30	122785-9	155	7,90	127605-2	312	31,50	143396-7	243	4,40	1910E1-5	47	300,00
369224808	343	2,60	122791-4	155	29,00	127750-3	189	14,10	143677-9	312	1,70	1910E2-3	47	316,00
369224809	343	4,40	122793-0	156	18,20	12L	101	32,00	143787-2	312	32,00	1910H8-2	336	70,00
369224810	343	5,00	122829-5	83	65,00	12S	101	24,00	143787-2	314	32,00	1910H9-0	336	73,00
369224811	343	11,80	122846-5	182	14,00	132025-7	316	4,10	144163-3	207	3,50	1910J1-0	47	89,00
369224812	343	11,80	122852-0	246	3,80	132126-1	118	169,00	14L	101	34,00	1910M4-5	312	6,10
369224815	343	31,00	122852-0	317	3,80	134182-7	316	11,10	14S	101	24,00	1910M7-9	335	18,00
369224816	343	31,00	122853-8	187	5,20	134279-2	119	150,00	150980-1	200	5,50	1910N0-0	312	22,25
369224819	343	5,20	122853-8	317	5,20	134745-9	142	20,00	151517-7	317	8,80	1910R1-6	354	24,50
369224820	343	5,20	122854-6	245	27,00	134746-7	142	20,00	151517-7*	206	8,80	1910R2-4	354	35,00
369224821	343	11,80	122867-7	144	6,50	134803-1	88	30,00	151749-6	200	5,50	1910R3-2	312	15,50
369224822	343	11,80	122868-5	144	7,20	134825-1	141	5,20	151750-1	200	5,50	1910T1-0	336	42,00
369224823	343	11,80	122878-2	88	14,00	134825-1	141	5,20	151751-9	200	8,60	1910T1-0	336	42,00
369224824	343	11,80	122884-7	246	6,40	134826-9	141	5,20	151780-2	206	2,60	1910T2-8	336	42,00
369224825	343	31,00	122884-7	317	6,40	134827-7	141	6,90	152456-4	206	22,00	1910T2-8	336	42,00
369224826	343	31,00	122889-7	182	9,60	134828-5	141	5,50	152464-5	312	4,50	1910V6-4	330	14,00
369224827	343	31,00	122889-7	182	9,60	134829-3	141	5,20	152491-2	207	2,50	1910V6-4	330	14,00
369224828	343	31,00	122889-7	182	9,60	134830-8	141	5,20	152492-0	181	3,05	1910W0-3	331	20,00
381224230	341	6,00	122889-7	182	9,60	134831-6	141	6,00	152498-8	243	50,00	1910W0-3	331	20,00
381224240	342	17,00	122889-7	182	9,60	134832-4	141	6,00	152554-4	88	9,10	1910Y3-1	312	13,50
382224300	342	20,00	122889-7	182	9,60	134833-2	141	7,70	152992-0	312	32,50	1910Y4-9	312	33,25
382224310	341	8,50	122889-7	182	9,60	134834-0	141	7,70	152992-0	314	32,50	1911B3-6	351	1.350,00
384224270	342	23,00	122891-0	182	11,00	134835-8	141	8,20	153409-6	186	18,90	1911B5-2	312	13,50
385224150	341	25,00	122891-0	182	11,00	134836-6	141	8,60	153489-2	181	1,20	1911B6-0	312	25,00
385224240	342	17,00	122891-0	182	11,00	134837-4	141	8,60	153489-2	187	1,20	1911B7-8	312	28,00
385224250	341	9,50	122891-0	182	11,00	134839-0	141	9,40	158024-1	337	1,70	1911J1-6	336	62,00
394114272	189	64,00	122891-0	182	11,00	134840-5	141	6,90	158057-6	88	4,90	1911J2-4	336	68,00
680224200	342	18,00	122891-0	182	11,00	134841-3	141	8,20	158131-0	88	11,00	1911K4-7	351	115,00
953003040	332	2,30	122891-0	182	11,00	134842-1	141	9,10	158324-9	196	3,40	1911K5-5	351	120,00
953003060	332	6,90	122891-0	182	11,00	134843-9	141	11,60	158325-7	196	8,95	1911K6-3	351	83,00
953003070	332	2,30	122891-0	182	11,00	134844-7	141	8,20	158326-5	196	7,80	1911T4-0	44	134,00
953003090	332	2,30	122907-1	346	27,00	134845-5	141	12,70	158476-6	331	21,00	1911Y2-9	342	30,00
953003090	348	2,30	122911-0	182	8,90	134846-3	141	9,90	158875-2	144	7,20	1911Y3-7	342	32,00
953003100	332	2,30	122913-6	182	17,40	134847-1	141	13,20	158876-0	144	7,80	191239-7	244	30,00
953003110	332	2,30	122930-6	245	95,00	134848-9	141	9,60	15L	101	35,00	1912R3-4	312	17,00
953009000	332	14,90	122D11-0	88	33,00	134849-7	141	13,80	15S	101	25,00	191383-0	324	31,00
953030010	332	16,00	123004-6	156	3,30	134851-0	141	6,90	161046-2	155	27,00	191657-9	312	15,40
953100090	332	6,60	123022-4*	286	14,00	134853-6	141	12,10	161377-9	349	37,00	191725-8	155	14,30
957173190	188	21,15	123062-2	156	3,05	134854-4	141	25,00	162172-0	196	40,95	191750-9	317	14,30
957802600	188	434,00	123098-1	182	7,70	134855-2	141	11,00	162258-0	181	13,70	191897-9	260	12,10
980008103	345	12,70	123098-1	182	7,70	134856-0	141	22,00	162264-5	181	16,10	191A01-6	351	146,00
980008106	345	2,05	123098-1	182	7,70	134857-8	141	11,00	162518-0	312	20,10	191A50-3	142	22,00
980008107	345	7,20	123098-1	182	7,70	134858-6	141	19,30	162635-6	312	10,50	191A51-1	142	22,00
980008112	345	12,10	123098-1	182	7,70	134859-4	141	20,00	162B56-4	335	13,15	191A57-9	46	287,00
980008118	345	33,00	123098-1	182	7,70	134860-9	141	14,30	163080-8	283	11,60	191A59-5	41	1.020,00
980008120	345	4,40	123099-9	182	8,30	134861-7	141	27,00	163411-1	182	32,00	191A64-2	41	728,00
980008121	345	8,20	123099-9	182	8,30	134862-5	141	16,00	163453-5	260	7,60	191A76-5	45	138,00
980008125	345	9,90	123099-9	182	8,30	134863-3	141	24,00	164095-8	186	1,95	191A77-3	45	78,00
980008210	345	6,40	123099-9	182	8,30	134864-1	141	25,00	164095-8	243	1,95	191A78-1	45	47,00
980008211	345	31,00	123099-9	182	8,30	134865-9	141	24,00	164379-4	283	14,90	191A80-4	45	66,00
988000040	346	42,00	123099-9	182	8,30	134867-5	141	35,00	164388-3	283	12,70	191A81-2	45	98,00
988000606	346	75,00	123101-8	244	16,00	134870-6	142	72,00	164393-0	283	23,00	191B03-8	335	86,00
988002256	345	4,70	123144-0	18										

Código	Pag	P.V.P.	Código	Pag	P.V.P.	Código	Pag	P.V.P.	Código	Pag	P.V.P.	Código	Pag	P.V.P.
191C26-2	312	23,00	191M34-3	317	14,90	192349-3	272	8,20	194270-2	286	44,00	195548-6	316	8,80
191C30-1	312	20,00	191M50-5	42	58,00	192349-3	312	8,20	194281-7	142	30,00	195551-7	312	29,00
191C50-5	41	1.901,00	191M56-3	339	546,00	192349-3	314	8,20	194289-1	183	2,20	195552-5	312	-
191D12-9	312	12,30	191M75-9	339	496,00	192349-3	316	8,20	194330-0	144	26,00	195553-3	312	-
191D33-1	336	31,00	191M77-5	315	-	192419-8	312	3,50	194367-7	242	198,00	1912R3-4	312	27,00
191D33-1	336	31,00	191M78-3	315	10,00	192439-2	142	165,00	194367-7	272	198,00	195559-1	286	3,60
191D34-9	336	36,00	191M79-1	315	10,00	192440-7	142	74,00	194367-7	284	198,00	195559-1	313	3,60
191D34-9	336	36,00	191M90-3	41	100,00	192454-6	183	42,00	194368-5	242	76,00	195562-2	285	88,00
191D71-3	312	42,00	191N09-8	41	276,00	192505-5	242	31,00	194368-5	272	76,00	195563-0	285	75,00
191D76-3	312	6,40	191N23-4	337	32,00	192506-3	242	122,00	194368-5	284	76,00	195564-8	286	6,50
191D79-7	312	4,70	191N24-2	337	24,00	192507-1	242	91,00	194385-5	243	30,00	195566-4	339	90,00
191D90-9	342	18,00	191N62-4	42	166,00	192518-6	312	14,50	194385-5	284	30,00	195584-2	41	120,00
191D91-7	342	18,00	191N69-0	41	80,00	192523-3	206	22,00	194385-5	272	30,00	195595-7	348	203,00
191D92-5	342	18,00	191N76-3	41	69,00	192562-3	312	9,70	194500-1	143	89,00	195599-9	188	70,00
191D93-3	342	26,00	191N90-9	202	10,20	192562-3	315	9,70	194533-6	41	81,00	195663-6	339	120,00
191E07-8	41	171,00	191N91-7	202	12,70	192563-1	312	9,30	198745-3	312	4,40	195717-9	339	287,00
191E27-2	339	126,00	191N92-5	202	12,70	192563-1	315	9,30	194568-7	83	74,00	195797-5	43	49,00
191E30-3	312	-	191P11-3	347	153,00	192613-2	312	15,40	194579-2	284	39,00	195798-3	43	51,00
191E39-5	312	11,70	191P18-9	312	40,00	192625-5	245	20,00	194581-5	85	14,30	195858-1	348	7,00
191E43-4	346	14,50	191P20-2	312	47,25	192628-9	244	43,00	194582-3	85	5,50	195870-1	85	110,00
191E54-9	84	171,00	191P22-8	312	43,05	192629-7	204	21,00	194583-1	85	5,10	195902-4	84	122,00
191F24-4	45	77,00	191P24-4	312	31,50	192669-5	244	76,00	194588-1	41	50,00	196008-1*	121	12,10
191F25-2	45	74,00	191P26-0	312	18,70	192694-6	208	50,00	194622-7	41	121,00	196066-7	41	61,00
191F46-4	83	55,00	191P28-6	312	16,80	192732-4	272	8,80	194663-3	336	38,00	196074-8	86	112,00
191F47-2	83	34,00	191P31-7	312	12,00	192755-2	348	208,00	194666-7	336	44,00	196074-8	313	112,00
191F49-8	84	52,00	191P37-5	334	75,00	192877-8	121	37,00	194671-4	336	77,00	196093-4	285	89,00
191F78-1	45	29,00	191P72-3	339	170,00	192985-5	185	15,00	194678-0	337	2,20	196093-4	285	89,00
191F79-9	45	29,00	191P89-6	44	95,00	192988-9	185	26,00	194681-1	336	23,00	196122-3	345	2,80
191F80-4	45	61,00	191P97-7	335	7,00	192989-7	206	7,70	194681-1	336	23,00	196129-9	346	55,00
191F81-2	181	52,00	191R02-6	219	12,00	193011-3	185	25,00	194681-1	336	23,00	196148-5	343	5,20
191F81-2	312	52,00	191R02-6	312	12,00	193012-1	185	20,00	194681-1	336	23,00	196152-4	204	26,00
191F95-1	84	121,00	191R06-8	41	401,00	193036-7	155	29,00	194681-1	336	23,00	196162-1	84	32,00
191G00-4	84	121,00	191R51-3	336	45,00	193036-7	312	29,00	194684-5	181	14,80	196235-0	41	100,00
191G06-2	181	87,00	191R51-3	336	45,00	193055-3	208	87,00	194691-8	257	22,00	196246-5	293	215,00
191G06-2	312	87,00	191R51-3	336	45,00	193070-7	208	101,00	194692-6	257	22,00	196285-5	292	88,00
191G09-6	334	7,00	191R52-1	336	73,00	193072-3	208	102,00	194733-8	286	3,00	196286-3	292	88,00
191G09-6	316	7,00	191R52-1	336	73,00	193141-0	185	68,00	194733-8	312	3,00	196287-1	292	88,00
191G14-3	331	15,50	191R52-1	336	73,00	193143-6	185	25,00	194746-9*	206	5,50	196288-9	292	88,00
191G14-3	331	15,50	191R53-9	336	110,00	193178-7	281	22,00	194852-0	294	48,00	196289-7	292	110,00
191G14-3	331	15,50	191R53-9	336	110,00	193180-0	281	26,00	194906-3	144	40,00	196290-2	292	81,00
191G15-1	331	17,00	191R54-7	336	155,00	193201-8	200	7,80	194921-7	187	8,20	196291-0	292	81,00
191G15-1	331	17,00	191R54-7	336	155,00	193202-6	200	5,20	194925-9	242	117,00	196292-8	292	81,00
191G16-9	331	18,00	191R55-5	336	155,00	193203-4	120	36,00	194925-9	272	117,00	196293-6	292	81,00
191G16-9	331	18,00	191R56-3	336	170,00	193224-6	121	43,00	194925-9	284	117,00	196294-4	292	81,00
191G16-9	331	18,00	191T38-7	339	193,00	193226-2	120	35,00	194930-6	196	15,40	196295-9	260	116,00
191G16-9	331	18,00	191T87-4	331	19,00	193228-8	121	40,00	194934-8	286	11,60	196335-6	346	55,00
191G17-7	331	19,00	191T88-2	331	21,50	193293-7	206	8,10	194934-8	312	11,60	196345-3	339	299,00
191G17-7	331	19,00	191T91-3	330	30,00	193294-5	206	13,20	195050-9	336	37,00	196351-8	44	46,00
191G22-4	331	15,00	191T92-1	330	32,50	193317-9	118	251,00	195055-9	155	10,60	196354-2	189	987,00
191G24-0	331	18,00	191T96-3	312	21,00	193318-7	121	51,00	195136-9	286	57,00	196388-5	41	177,00
191G25-8	331	19,00	191U00-8	41	761,00	193331-5	283	14,30	195173-3	85	7,50	196426-3	41	315,00
191G67-2	143	138,00	191U13-9	41	859,00	193332-3	283	10,20	195173-3	312	7,50	196520-1	313	5,50
191G95-7	330	21,00	191U86-2	352	27,00	193334-9	283	11,60	195176-7	337	52,00	196613-4	285	28,00
191G96-5	330	29,50	191U88-8	352	37,00	193335-7	283	17,30	195179-1	85	9,00	196643-5	334	14,70
191G96-5	330	29,50	191V02-0	131	21,00	193336-5	283	13,20	195179-1	312	9,00	196643-5	317	14,70
191G96-5	330	29,50	191V06-2	131	37,00	193338-1	283	13,80	195187-2	337	62,00	196664-7	242	42,00
191H00-0	330	12,00	191V67-2	312	24,00	193339-9	283	15,40	195239-9	181	52,00	196684-1	204	30,00
191H00-0	330	12,00	191V68-0	312	9,90	193340-4	283	14,30	195239-9	312	52,00	196685-9	204	26,00
191H00-0	330	12,00	191V69-8	312	43,00	193448-4	282	26,00	195240-4	244	9,60	196686-7	204	29,00
191H01-8	330	20,00	191V70-3	312	30,00	193449-2	282	7,20	195246-2	294	4,70	196688-3	336	134,00
191H01-8	330	20,00	191W19-9	41	166,00	193449-2	312	7,20	195272-1	337	25,00	196688-3	336	134,00
191H01-8	330	20,00	191W37-7	41	35,00	193472-7	85	49,00	195299-1	341	21,95	196752-0	339	161,00
191H02-6	330	20,00	191W58-9	45	45,00	193472-7	312	49,00	195311-7	42	77,00	196792-8	88	27,00
191H02-6	330	20,00	191W90-3	83	10,50	193483-2	279	5,50	195333-7	243	3,30	196845-3	181	81,00
191H02-6	330	20,00	191X11-1	333	2,20	193516-3	272	10,20	195354-9	183	55,00	196845-3	313	81,00
191H03-4	330	22,00	191X13-7	333	2,20	193517-1	272	32,00	195385-8	181	71,00	196858-4	86	82,00
191H03-4	330	22,00	191X15-3	333	2,20	193519-7	121	55,00	195385-8	312	71,00	196858-4	313	82,00
191H08-4	330	18,00	191X17-9	333	2,80	193521-0	196	31,20	195423-6	41	57,00	196875-4	41	118,00
191H11-5	330	15,00	191X19-5	333	5,00	193523-6	196	16,70	195432-5	312	7,50	196933-6	41	220,00
191H12-3	330	20,00	191X21-8	333	14,30	193618-5	207	35,00	195433-3	312	63,00	196953-0	242	56,00
191J13-3	335	10,00	191X23-4	333	18,70	198911-2	121	7,20	195433-3	314	63,00	196961-1	313	2,00
191J39-5	41	513,00	191X25-0	333	4,40	193712-3	206	6,70	195434-1	312	63,00	197005-0	242	70,00
191J50-7	42	133,00	191X27-6	333	5,00	193730-1	246	4,10	195434-1	314	63,00	197010-7	345	5,50
191J51-5	42	193,00	191X29-2	333	5,00	193733-5	312	31,50	195435-9	312	117,00	197043-2	143	32,00
191J59-9	46	397,00	191X35-7	312	14,40	193822-6*	121	28,00	195435-9	314	117,00	197166-6	313	66,15
191J65-4	41	413,00	191X40-4	84	121,00	193902-8	155	75,00	195436-7	312	77,00	197168-2	87	57,00
191J81-6	41	540,00	191X65-8	41	530,00	193903-6	183							

Código	Pag	P.V.P.	Código	Pag	P.V.P.	Código	Pag	P.V.P.	Código	Pag	P.V.P.	Código	Pag	P.V.P.
197366-8	349	54,00	198751-8	313	4,40	213482-9	140	1,20	40S	101	72,00	44S	101	78,00
197367-6	349	47,00	198757-6	313	61,00	213570-2	140	1,60	410047-0	187	0,80	450066-4	206	0,95
197396-9	41	75,00	198757-6	314	61,00	21L	101	47,00	410306-2	313	3,60	450770-5	206	2,65
197406-2	41	97,00	198768-1	339	130,00	21S	101	30,00	410899-9	313	1,50	450819-1	285	3,40
197422-4	41	248,00	198854-8	342	14,00	221502-5	280	18,90	412088-2	186	3,50	450963-4	144	1,95
197462-2	242	29,00	198885-7	242	27,00	224415-9	182	1,70	412911-1	336	5,30	450967-6	144	1,30
197580-6	42	151,00	198885-7	272	27,00	224515-5	199	5,50	412911-1	336	5,30	450968-4	144	1,30
197599-5	41	154,00	198885-7	284	27,00	224543-0	182	2,10	412911-1	336	5,30	451241-5	313	2,30
197610-3	185	2,30	198900-7	43	59,00	22L	101	47,00	412912-9	336	8,70	451244-9	313	4,30
197615-3	41	149,00	198909-9	352	35,00	22S	101	31,00	412912-9	336	8,70	451329-1	313	1,60
197626-8	41	882,00	198915-4	313	7,90	23L	101	49,00	412912-9	336	8,70	451330-6	242	6,60
197712-5	332	8,00	198987-9	285	33,00	23S	101	32,00	413094-0	206	1,40	451424-7	313	2,35
197750-7	339	244,00	198990-0	313	2,35	242075-5	294	21,00	413101-9	242	4,40	452055-5	337	2,65
197822-8	352	14,20	198992-6	313	2,35	242077-1	294	11,60	413102-7	242	16,50	452093-7	331	2,10
197824-4	352	14,70	198993-4	83	6,60	242088-6	294	15,40	413148-3	285	5,05	452093-7	331	2,10
197828-6	354	10,90	199008-0	351	240,00	242094-1	294	17,70	413150-6	285	2,85	452093-7	331	2,10
197831-7	353	17,30	199009-8	351	260,00	24L	101	51,00	413859-0	313	1,50	452093-7	331	2,10
197837-5	353	27,00	199010-3	322	13,80	24S	101	33,00	413G38-2	43	35,00	452093-7	331	2,10
197840-6	353	33,00	199041-2	313	7,70	252627-4	283	11,00	413G39-0	143	27,00	452093-7	331	2,10
197842-2	352	24,00	199083-6	239	73,00	256282-4	140	1,20	413G40-5	43	33,00	452093-7	331	2,10
197845-6	353	30,00	199085-2	239	73,00	256283-2	140	1,20	413G70-6	335	10,00	452123-4	335	12,00
197847-2	353	41,00	199087-8	239	73,00	256284-0	140	2,10	413J77-0	313	-	453378-4	207	10,40
197850-3	353	48,00	199137-9	46	201,00	256812-1	244	26,00	415021-3	316	-	454226-0	44	4,10
197853-7	354	9,00	199138-7	83	24,00	257022-3	246	0,85	415412-8	286	5,40	454407-6	43	5,00
197864-2	354	25,00	199139-5	83	55,00	257060-5	246	1,40	415452-6	156	3,70	454842-8	285	2,65
197867-6	354	17,40	199140-0	242	48,00	257262-3	246	0,85	415452-6	313	3,70	455288-1	207	3,05
197870-7	352	49,00	199140-0	284	48,00	25L	101	54,00	415486-9	118	0,95	455291-2	207	9,40
197873-1	354	37,00	199142-6	313	107,00	25S	101	37,00	415524-7	272	0,80	455293-8	207	25,00
197876-5	352	26,00	199142-6	86	107,00	262542-4	207	2,35	415579-2	281	8,00	455591-0	144	2,00
197879-9	354	2,30	199142-6	87	20,00	268056-1	140	1,20	416041-0	313	1,50	456586-6	313	1,00
197883-8	354	6,50	199143-4	313	20,00	268057-9	140	1,20	416348-4	207	11,10	456587-4	313	2,10
197886-2	354	21,00	199143-4	313	20,00	26L	101	57,00	416368-8	156	2,20	456914-5	313	5,50
197888-8	334	-	199168-8	349	105,00	26S	101	39,00	416477-3	272	0,55	457801-1	313	4,75
197888-8	335	-	199169-6	349	132,00	273457-0	88	11,60	416772-1	246	6,00	458184-2	313	7,00
197889-6	334	7,00	199178-5	322	11,00	273472-4	88	11,00	417113-4	245	0,65	458184-2	315	7,00
197889-6	335	7,00	199201-6	285	83,00	273496-0	88	12,10	417322-5	187	8,10	458342-0	336	4,45
197889-6	335	7,00	199202-4	285	35,00	273646-7	332	2,45	417322-5	207	8,10	458342-0	337	4,45
197889-6	335	7,00	199231-7	243	9,50	27L	101	60,00	417671-0	207	18,00	458467-0	313	0,60
197889-6	335	7,00	199232-5	242	56,00	27S	101	40,00	417852-6	272	2,80	458891-7	313	3,50
197893-5	205	18,70	199318-5	339	582,00	28L	101	61,00	417853-4	272	1,10	458919-1	313	1,75
197894-3	205	22,00	199339-7	339	610,00	28S	101	45,00	417853-4	313	1,10	459056-4	313	2,65
197895-1	204	29,00	199386-8	243	16,70	29L	101	64,00	418500-0	313	3,05	459353-8	313	2,45
197896-9	204	18,20	199388-4	313	63,00	29S	101	46,00	418500-0	316	3,05	459356-2	313	2,45
197897-7	204	16,00	199388-4	314	63,00	30L	101	67,00	418529-6	307	3,20	459937-2	43	6,60
197899-3	313	28,00	199424-6	204	28,00	30S	101	47,00	419242-9	231	2,80	459938-0	43	8,20
197901-2	313	7,00	199439-3	313	4,10	313248-8	219	2,80	419242-9	331	2,80	45L	101	133,00
197922-4	199	61,00	199453-9	314	17,60	31L	101	70,00	419242-9	331	2,80	45S	101	79,00
197925-8	199	62,00	199454-7	313	31,00	31S	101	48,00	419242-9	331	2,80	46L	101	137,00
197928-2	199	61,00	199480-6	41	540,00	321492-3	283	16,50	419288-5	331	3,50	46S	101	88,00
198000-3	41	56,00	199486-4	313	-	321812-1	283	10,80	419288-5	331	3,50	47L	101	146,00
198043-5	207	9,40	199491-1	313	39,00	322119-8	144	20,00	419288-5	331	3,50	47S	101	90,00
198068-9	339	355,00	199493-7	313	20,00	322120-3	144	8,60	419288-5	331	3,50	48L	101	151,00
198077-8	41	717,00	199493-7	314	20,00	322124-5	144	13,20	419288-5	331	3,50	48S	101	91,00
198116-4	41	661,00	199514-5	183	28,00	322125-3	144	13,80	419288-5	331	3,50	49L	101	153,00
198149-9	313	15,40	199557-7	84	11,80	322126-1	144	14,90	419288-5	331	3,50	49S	101	94,00
198186-3	41	77,00	199563-2	84	126,00	322177-4	118	1,20	419288-5	331	3,50	50L	101	155,00
198192-8	41	66,00	199581-0	84	155,00	322932-4	244	7,00	419525-7	293	1,55	50S	101	96,00
198345-9	341	18,00	199585-2	84	155,00	324149-5	282	11,80	41L	101	109,00	652739-7	186	105,00
198362-9	313	11,80	199596-7	84	9,40	324219-0	118	2,00	41S	101	73,00	699020-5	144	13,40
198362-9*	85	11,80	199618-3	219	7,00	327095-1	244	5,90	421093-8	200	4,40	721710-3	173	16,50
198363-7	41	13,50	199618-3	313	7,00	327684-2	347	33,00	421342-3	85	2,45	721715A3	173	25,00
198383-1	344	30,00	199624-8	219	8,80	327685-0	347	39,00	421646-3	200	2,80	724406-5	173	46,00
198401-5	336	9,10	199624-8	313	8,80	327687-6	347	29,00	421648-9	200	3,70	724409-9	173	46,00
198408-1	336	30,00	199627-2	219	11,50	32L	101	73,00	421664-1	85	3,90	725092-5	325	43,00
198426-9	344	14,20	199627-2	313	11,50	32S	101	49,00	422268-2	313	0,35	725093-3	325	46,00
198440-5	181	146,00	199664-6	84	97,00	33L	101	78,00	422437-5	313	8,50	725129-8	324	73,00
198440-5	312	146,00	199687-4	41	121,00	33S	101	50,00	422440-6	313	0,55	725130-3	324	62,00
198440-5	313	146,00	199709-0	182	10,10	341705-6	200	3,60	422449-8	313	2,95	725255-3	325	69,50
198516-8	337	64,00	199710-5	182	10,60	341796-7	324	1,10	422908-2	313	1,05	733232-1	279	14,50
198527-3	313	15,40	199725-2	45	29,00	342328-3	200	3,05	422909-0	313	0,30	733240-2	279	3,90
198529-9	313	15,40	199728-6	45	35,00	342332-2	208	4,10	423029-3	200	3,00	743008-8	199	25,00
198533-8	313	26,00	199729-4	45	36,00	342390-8	155	2,20	423035-8	200	4,10	743012-7	199	16,50
198537-0	313	7,70	199730-9	45	15,40	342428-9	286	7,30	423036-6	200	2,35	743015-1	199	9,50
198538-8	313	5,80	199731-7	45	15,40	343411-9	73	31,00	423149-3	200	2,80	743016-9	199	10,20
198540-1	313	5,80	199773-1	313	248,00	343411-9	82	31,00	423154-0	85	0,80	743025-8	199	5,00
198544-3	313	8,80	199872-9	341	25,00	343433-9	154	3,90	423312-8	200	2,20	743053-3	199	21,00
198545-1	313	8,80	199874-5	341	38,00	343577-5	283	0,80	423313-6	200	2,80	743060-6	199	16,50
198547-7	313	8,80	199897-3	348	4,40	344364-5	283	2,80	423315-2	200	2,50	743080-0	170	27,00
198552-4	313	5,80	199937-7	207	187,00	344586-7	200	2,80	423316-0	200	3,05			

Código	Pag	P.V.P.
763229-6	120	10,10
763236-9	185	3,15
763252-1	120	26,00
763258-9	282	5,80
763601-2	281	41,00
763606-2	282	4,10
763606-2	282	4,10
763607-0	281	2,80
763608-8	281	3,30
763608-8	282	3,30
763615-1	282	3,30
763618-5	281	2,80
763620-8	185	10,80
763620-8	185	10,80
763622-4	281	16,50
763625-8	185	12,70
763627-4	185	13,20
763628-2	281	16,50
763629-0	282	6,60
763632-1	281	26,00
763636-3	281	11,60
763637-1	281	9,60
763645-2	185	2,60
763646-0	185	15,40
763652-5	282	4,40
763662-2	281	4,10
763663-0	281	4,40
763664-8	185	1,40
763668-0	185	1,65
763669-8	185	18,20
763670-3	185	9,10
763671-1	185	18,20
763674-5	282	7,20
763676-1	282	16,00
763677-9	282	13,20
763801-4	282	3,30
763803-0	282	3,30
763804-8	282	3,30
763807-2	282	3,90
765009-6	83	2,45
766002-3	120	10,50
766004-9	120	15,00
766007-3	120	11,60
766010-4	120	31,00
766016-2	121	9,60
781006-4	281	1,95
781008-0	281	1,95
781011-1	281	2,20
781012-9	281	2,30
781019-5	324	3,30
781028-4	324	3,20
781030-7	281	2,80
781039-9	185	1,25
781203-2	185	2,80
781206-6	185	4,10
781213-9	156	2,20
781213-9	281	2,20
782209-3	156	2,25
782401-1	281	0,95
782423-1	185	1,70
783002-8	348	1,95
783012-5	348	0,60
783201-2	272	1,10
783201-2	324	1,10
783202-0	156	1,10
783202-0	272	1,10
783202-0	324	1,10
783208-8	156	1,10
783208-8	324	1,10
783230-5	156	2,80
784643-3	144	5,00
784801-1	132	4,50
784811-8	132	4,00
792259-0	234	11,00
792287-5	324	34,00
792292-2	324	28,00
792299-8	234	14,30
792533-6	324	48,00
792534-4	324	63,00
792536-0	324	48,00
792537-8	324	81,00
792556-4	257	25,00
792558-0	257	40,00
792559-8	257	40,00
792560-3	257	40,00
792567-9	257	40,00
792728-1	324	29,00
793346-8	154	42,00
794050-2	180	8,00
794053-6	180	1,40
794059-4	180	4,00
794060-9	156	13,80
794061-7	156	11,60

Código	Pag	P.V.P.
794173-6	204	13,20
794176-0	204	24,00
794379-6	153	164,00
794381-9	153	208,00
794383-5	153	167,00
794384-3	153	175,00
794530-8	349	13,20
794558-6	205	26,00
794560-9	204	24,00
794618-4	204	20,00
798035-0	78	98,00
P-06052	131	8,80
798385-3	80	217,00
911138-5	315	0,35
A-15051	324	24,00
A-16564	280	392,00
A-16570	280	389,00
A-16586	280	411,00
A-16592	280	460,00
A-16601	280	528,00
A-16617	280	810,00
A-19875	75	89,00
A-19897	75	43,00
A-31485	79	123,00
A-34235	312	37,00
A-34235	314	37,00
A-34447	201	22,00
A-34453	201	22,00
A-34469	201	20,00
A-34475	201	17,70
A-34481	201	17,70
A-34534	201	22,00
A-34540	201	20,00
A-34556	201	19,30
A-34562	201	25,00
A-34578	201	25,00
A-34584	201	24,00
A-34590	201	24,00
A-34609	201	20,00
A-36706*	118	396,00
A-43692	116	14,40
A-47450	244	109,00
A-47846	313	34,00
A-68155	82	71,00
A-68161	73	86,00
A-80391	265	11,20
A-80400	266	10,60
A-80416	268	11,70
A-83951	324	28,00
A-85248	188	9,40
A-85400	154	11,00
A-85494	141	10,50
A-85503	141	21,00
A-85519	141	11,00
A-85525	141	21,00
A-85531	141	11,00
A-85547	141	21,00
A-85553	141	11,00
A-85569	141	21,00
A-85575	141	11,00
A-85581	141	20,00
A-85628	266	6,60
A-85634	266	7,00
A-85640	266	5,60
A-85656	264	4,50
A-85662	264	4,20
A-85678	264	4,20
A-85684	265	6,00
A-85690	265	6,20
A-85709	264	4,80
A-85715	265	5,90
A-85721	268	9,00
A-85737	267	5,60
A-85743	267	5,40
A-85759	267	5,40
A-85765	266	5,60
A-85771	266	6,30
A-85787	267	6,80
A-85793	266	4,80
A-85802	271	5,90
A-85818	270	7,80
A-85852	270	5,90
A-85868	270	4,80
A-85874	270	5,90
A-85880	271	6,20
A-85896	271	9,60
A-85905	271	6,50
A-85911	270	5,90
A-85927	270	7,50
A-85933	270	4,80
A-86169	236	48,00
A-86290	266	12,40
A-86309	265	8,60

Código	Pag	P.V.P.
A-86315	265	11,80
A-86468	236	74,00
A-86561	267	7,40
A-86583	266	7,80
A-86664	349	49,00
A-87579	240	254,00
A-89931	141	4,40
B-00898	116	52,00
B-00907	116	55,00
B-00913	116	55,00
B-00929	116	55,00
B-00935	116	55,00
B-00941	116	55,00
B-00957	116	56,00
B-00979	116	58,00
B-00985	116	67,00
B-00991	116	67,00
B-01002	116	79,00
B-01018	116	80,00
B-01024	116	88,00
B-01030	116	97,00
B-01046	116	101,00
B-01127	116	253,00
B-01177	116	10,50
B-01971	343	2,45
B-02870	154	39,00
B-05016	349	34,00
B-05038	252	17,70
B-05044	252	15,40
B-05072	238	46,00
B-05153	252	16,00
B-05169	250	13,80
B-05175	253	16,00
B-06292	264	6,80
B-06432	163	22,00
B-06460	264	8,60
B-06476	264	8,60
B-06482	264	10,20
B-06890	268	26,00
B-06909	268	35,00
B-06921	82	14,30
B-07004	82	17,90
B-07010	82	20,00
B-07250	255	32,00
B-07325	240	47,00
B-07375	343	3,30
B-07674	269	106,00
B-07680	269	11,00
B-07705	269	73,00
B-07711	269	94,00
B-07733	269	90,00
B-08327	228	23,00
B-32580	236	48,00
B-32758	236	35,00
B-09042	236	35,00
B-33065	229	27,00
B-10300	79	106,00
B-10344	235	64,00
B-10372*	80	34,00
B-10388*	79	37,00
B-10394	255	36,00
B-10403	255	50,00
B-10506	141	5,20
B-10609	255	10,20
B-33532	234	26,00
B-10665-5	175	22,00
B-10970	265	13,60
B-10986	265	15,90
B-12289	166	225,00
B-12295	166	110,00
B-12712	159	148,00
B-12762	160	48,00
B-12778	160	49,00
B-12784	160	111,00
B-12809	255	28,00
B-12980	161	44,00
B-12996	161	49,00
B-13007	161	60,00
B-13035	161	97,00
B-13041	161	180,00
B-13057	161	235,00
B-13063	161	76,00
B-13085	161	29,00
B-13091	161	31,00
B-13172	161	58,00
B-13188	161	59,00
B-13194	161	79,00
B-13219	161	154,00
B-13225	161	281,00
B-13253	162	103,00
B-13269	162	185,00
B-13275	162	216,00
B-13459	159	214,00

Código	Pag	P.V.P.
B-13465	159	276,00
B-13471	159	330,00
B-13546	160	166,00
B-13552	160	197,00
B-13568	160	238,00
B-13699	232	34,00
B-14124	341	11,85
B-14146	341	13,40
B-14607	234	10,20
B-16667	257	60,00
B-16673	257	50,00
B-16689	257	49,00
B-16695	257	66,00
B-16776	250	17,70
B-16782	250	17,70
B-16798	251	9,60
B-16807	251	9,60
B-16813	252	9,60
B-16829	251	16,00
B-16835	250	12,70
B-16841	250	12,70
B-16857	249	22,00
B-16863	251	20,00
B-20395	256	12,10
B-20404	256	12,10
B-20410	256	12,10
B-20426	256	12,10
B-20432	256	12,10
B-20448	256	12,10
B-20454	256	12,10
B-20644	280	26,00
B-21098	165	37,00
B-21559	219	4,40
B-21618	219	4,20
B-21624	219	3,90
B-21630	219	3,60
B-21646	219	3,60
B-21652	219	3,60
B-21668	219	3,60
B-21674	219	4,40
B-21680	219	4,10
B-21696	219	4,10
B-21705	219	4,10
B-21711	219	4,10
B-21727	219	4,10
B-21733	219	4,40
B-21749	219	4,10
B-21755	219	4,10
B-21761	219	4,10
B-21777	219	3,90
B-21783	219	3,90
B-21799	219	3,30
B-21808	219	3,30
B-21814	219	3,30
B-21820	219	3,30
B-21951	165	40,00
B-22028	165	101,00
B-22947	219	3,60
B-22953	219	3,60
B-22969	219	4,10
B-23064	74	21,00
B-24876	135	29,00
B-24882	135	29,00
B-26490	135	28,00
B-26509	135	28,00
B-33766	232	30,00
B-28606	136	24,00
B-28662	175	61,00
B-28678	175	61,00
B-28684	175	77,00
B-28690	175	77,00



Código	Pag	P.V.P.	Código	Pag	P.V.P.	Código	Pag	P.V.P.	Código	Pag	P.V.P.	Código	Pag	P.V.P.
B-39403	198	45,00	B-47444	60	3,40	B-52847	180	17,00	B-58637	58	32,00	B-64901	215	15,40
B-39419	198	45,00	B-47450	60	5,00	B-52934	134	5,80	B-58659	58	39,00	B-64917	215	8,20
B-39425	198	45,00	B-47472	60	4,40	B-53986	162	25,00	B-58665	58	36,00	B-64923	215	9,40
B-39883	140	3,80	B-47488	60	5,60	B-53992	162	27,00	B-58687	58	48,00	B-64939	215	12,10
B-39899	140	3,80	B-47503	60	10,50	B-54025	162	35,00	B-58693	58	46,00	B-64945	216	21,00
B-39908	140	3,80	B-47525	60	15,60	B-54031	162	110,00	B-58702	58	52,00	B-64951	215	25,00
B-39914	140	3,80	B-47531	60	4,20	B-54053	162	79,00	B-58718	58	46,00	B-64967	216	25,00
B-39920	140	3,80	B-47547	60	5,60	B-54069	162	102,00	B-58724	58	58,00	B-64973	214	25,00
B-39936	140	3,80	B-47553	60	4,70	B-54081	136	36,00	B-58746	58	52,00	B-64989	216	9,60
B-39942	140	3,70	B-47569	60	5,20	B-54265	253	412,00	B-58752	58	67,00	B-64995	216	9,90
B-39958	140	4,40	B-47575	60	6,10	B-54346	348	198,00	B-58768	58	59,00	B-65006	216	17,10
B-39964	140	4,40	B-47581	60	7,00	B-54352	348	203,00	B-58774	58	74,00	B-65012	216	18,20
B-39970	140	4,70	B-47606	60	11,70	B-54368	348	229,00	B-58780	58	95,00	B-65028	217	28,00
B-39986	140	4,70	B-47612	60	16,10	B-54374	348	271,00	B-59075	62	21,00	B-65034	217	45,00
B-39992	140	4,70	B-47634	60	41,00	B-54380	348	50,00	B-62016	252	16,50	B-65040	217	25,00
B-40004	140	5,20	B-47640	60	5,80	B-54520	108	57,00	B-62496	59	3,40	B-65056	217	24,00
B-40076	140	3,20	B-47656	60	6,40	B-54667	134	2,90	B-62505	59	3,40	B-65062	218	24,00
B-40098	140	3,20	B-47662	60	7,80	B-54673	134	3,80	B-62511	59	4,00	B-65078	217	39,00
B-40107	140	3,20	B-47684	60	5,80	B-54704	63	12,50	B-62527	59	4,30	B-65084	217	25,00
B-40113	140	3,20	B-47690	60	7,20	B-55310	166	56,00	B-62608	59	4,10	B-65090	217	22,00
B-40135	140	3,70	B-47709	60	9,20	B-55326	166	104,00	B-62614	59	4,10	B-65109	217	22,00
B-40141	140	3,70	B-47721	60	12,80	B-55332	166	187,00	B-62620	59	4,70	B-65115	218	12,10
B-40163	140	4,00	B-47737	60	16,70	B-55572	249	18,70	B-62636	59	5,20	B-66400	220	13,80
B-40185	140	4,00	B-47759	60	44,00	B-55588	249	22,00	B-62642	59	5,60	B-66416	220	14,90
B-40191	140	4,50	B-47765	60	5,80	B-55594	249	29,00	B-62664	59	5,50	B-66422	220	25,00
B-40200	140	5,90	B-47771	60	6,70	B-56378	173	3,90	B-62670	59	5,50	B-66438	220	10,80
B-40216	140	6,20	B-47787	60	7,80	B-56390	173	4,40	B-62686	59	6,00	B-66444	220	25,00
B-40222	140	6,40	B-47793	60	10,00	B-56437	99	12,80	B-62692	59	6,60	B-66450	220	26,00
B-40238	140	7,20	B-47802	60	7,20	B-56758	235	47,00	B-62701	59	6,90	B-66466	221	14,30
B-40244	140	10,40	B-47818	60	8,90	B-56714	235	73,00	B-62739	59	7,40	B-66472	221	7,20
B-40543	258	51,00	B-47824	60	10,00	B-56801	235	71,00	B-62745	59	8,00	B-66494	222	30,00
B-40559	258	51,00	B-47830	60	15,60	B-56786	235	61,00	B-62751	59	8,60	B-66503	222	30,00
B-40565	258	50,00	B-47846	60	18,40	B-57336	234	50,00	B-62767	59	8,80	B-66519	221	41,00
B-40917	179	10,20	B-47852	60	45,00	B-57401	100	3,50	B-62773	59	9,90	B-66547	222	29,00
B-40923	179	10,20	B-47868	60	8,10	B-57417	100	3,50	B-62795	59	11,00	B-66553	222	22,00
B-40939	179	10,20	B-47874	60	9,40	B-57423	100	4,10	B-62804	59	11,60	B-66575	222	22,00
B-40945	179	10,20	B-47880	60	10,30	B-57439	100	4,10	B-62810	59	12,10	B-66793	129	4,90
B-40951	179	11,80	B-47896	60	16,20	B-57445	100	5,00	B-62826	59	12,40	B-66802	129	4,80
B-40967	179	11,80	B-47905	60	7,80	B-57451	100	5,00	B-62832	59	12,70	B-66818	129	6,00
B-40973	179	11,80	B-47911	60	9,50	B-57467	100	5,00	B-62854	59	13,20	B-66824	129	3,30
B-40989	179	11,80	B-47933	60	12,30	B-57473	100	5,60	B-62860	59	13,80	B-66830	129	3,40
B-42438	136	20,00	B-47949	60	18,40	B-57489	100	3,70	B-62876	59	14,40	B-66846	129	3,30
B-42450	136	20,00	B-47955	60	22,00	B-57495	100	3,80	B-62882	59	15,70	B-66852	129	3,40
B-42581	201	14,30	B-47961	60	33,00	B-57504	100	3,70	B-62898	59	16,30	B-66868	130	2,40
B-42597	201	14,30	B-47977	60	51,00	B-57510	100	4,40	B-62985	234	31,00	B-66874	130	2,95
B-42640	236	98,00	B-47983	60	14,40	B-57526	100	4,70	B-63149	233	63,00	B-66880	128	43,00
B-42662	236	98,00	B-48751	134	5,10	B-57532	100	14,80	B-63585	255	43,00	B-67206	254	290,00
B-42961	134	19,30	B-48767	134	6,40	B-57548	132	6,60	B-63591	255	51,00	B-67212	254	495,00
B-42977	134	20,00	B-48773	134	17,50	B-57554	134	6,70	B-63600	130	1,75	B-67290	236	70,00
B-42983	134	20,00	B-48789	134	17,50	B-57641	69	233,00	B-63616	130	1,75	B-67309	236	83,00
B-43131	250	17,70	B-48832	239	178,00	E-20133	69	270,00	B-63622	130	1,75	B-67480	218	48,00
B-43147	249	18,50	B-48860	239	196,00	B-57685	69	292,00	B-63638	130	1,75	B-67496	218	58,00
B-43153	250	17,70	B-49046	63	31,00	B-57700	69	361,00	B-63644	130	1,75	B-68127	59	2,80
B-43169	250	18,70	B-49052	62	15,60	B-57738	134	9,30	B-63650	130	1,75	B-68133	59	2,80
B-43175	250	22,00	B-49638	111	118,00	B-57744	134	11,40	B-63666	130	1,75	B-68177	59	21,00
B-43181	249	22,00	B-49703	258	22,00	B-57897	58	5,30	B-63672	130	1,75	B-68183	59	27,00
B-43197	250	22,00	B-49719	258	29,00	B-57906	58	5,60	B-63688	130	1,75	B-68199	59	33,00
B-43206	250	26,00	B-49725	111	149,00	B-57912	58	8,60	B-63694	130	1,75	B-68208	59	42,00
B-43212	249	26,00	B-49884	111	159,00	B-57928	58	8,90	B-63703	130	1,75	B-68236	59	26,00
B-43228	250	26,00	B-50295	106	41,00	B-57940	58	5,30	B-63719	130	2,60	B-68242	59	31,00
B-43234	253	22,00	B-51867	132	36,00	B-57956	58	5,60	B-63725	130	2,60	B-68258	59	41,00
B-43240	254	13,80	B-51910	175	13,10	B-57962	58	5,30	B-63731	130	2,60	B-68264	59	45,00
B-43256	253	28,00	B-51926	175	14,80	B-57978	58	5,60	B-63747	130	2,60	B-68317	135	25,00
B-43262	254	18,70	B-51932	175	16,50	B-57984	58	7,20	B-63753	130	3,00	B-68389	198	34,00
B-43278	253	32,00	B-51954	175	22,00	B-57990	58	8,60	B-63769	130	2,60	B-68395	198	33,00
B-46327	165	39,00	B-51960	175	24,00	B-58001	58	11,90	B-63775	130	2,60	B-68404	198	29,00
B-46333	165	42,00	B-51976	175	30,00	B-58023	58	7,50	B-63781	130	2,60	B-68410	198	29,00
B-46492	60	2,80	B-52043	255	24,00	B-58039	58	9,70	B-63797	130	2,60	B-68426	198	29,00
B-46501	60	3,05	B-52180	140	3,70	B-58045	58	12,20	B-63806	130	2,60	B-68432	107	47,00
B-46517	60	2,80	B-52211	140	4,80	B-58051	58	14,80	B-63812	130	2,60	B-68448	143	17,30
B-46523	60	2,80	B-52233	140	5,60	B-58067	58	6,70	B-64185	234	31,00	B-69478	111	118,00
B-46539	60	3,05	B-52249	140	6,40	B-58073	58	7,50	B-64238	72	12,20	B-80014	294	215,00
B-46545	60	3,40	B-52532	133	27,00	B-58089	58	10,90	B-64244	72	12,20	B-80020	294	316,00
B-46551	60	3,60	B-52532	133	27,00	B-58095	58	6,10	B-64250	72	17,80	B-80036	294	175,00
B-46567	60	3,90	B-52548	133	29,00	B-58104	58	6,40	B-64294	72	8,30	CP00000001	322	33,00
B-46573	60	4,70	B-52548	133	29,00	B-58110	58	7,50	B-64303	72	8,30	D-00016	61	1,30
B-46589	60	6,40	B-52554	133	49,00	B-58126	58	8,90	B-64319	72	12,30	D-00022	61	1,30
B-47036	240	44,00	B-52554	133	49,00	B-58132	58	12,20	B-64674	62	94,00	D-00038	61	1,30
B-47042	240	61,00	B-52582	133	27,00	B-58154	58	19,50	B-64799	214	18,20	D-00044	61	1,30
B-47058	240	66,00	B-52582	133	27,00	B-58176	58	7,00	B-64808	214	26,00	D-00050	61	1,30
B-47064	240	61,00	B-52598	133	29,00	B-58198	58	6,40	B-64814	214	13,80	D-00066	61	1,30
B-47232	60	3,40	B-52598	133	29,00	B-58207	58	7,20	B-64814-20	214	226,00	D-00072	61	1,60
B-47248	60	3,90	B-52607	133	49,00	B-58213	58	8,10	B-64820	214	19,30	D-00088	61	1,30
B-47298	60	2,80	B-52607	133</										

# ÍNDICE POR CÓDIGO

Código	Pag	P.V.P.
D-00197	61	1,95
D-00206	61	2,55
D-00228	61	1,60
D-00234	61	1,95
D-00240	61	1,95
D-00256	61	1,85
D-00262	61	2,00
D-00278	61	2,60
D-00290	61	3,70
D-00309	61	4,50
D-00321	61	3,60
D-00337	61	4,60
D-00359	61	4,50
D-00365	61	7,40
D-00371	61	5,90
D-00387	61	7,70
D-00393	61	10,50
D-00795	64	5,80
D-01155-25	61	23,00
D-01161-25	61	25,00
D-01177-25	61	30,00
D-01183-25	61	30,00
D-01199-25	61	37,00
D-01208-25	61	30,00
D-03274	61	1,60
D-03327	230	12,30
D-03333	230	14,70
D-03349	230	17,80
D-03707-25	61	41,00
D-03713-25	61	36,00
D-03729-25	61	41,00
D-03903	230	13,50
D-03919	230	16,50
D-03925	230	21,00
D-03931	230	25,00
D-05181	73	26,00
D-05228	91	1,25
D-05234	91	1,25
D-05240	91	1,25
D-05256	91	1,25
D-05262	91	1,25
D-05278	91	1,25
D-05284	91	1,25
D-05290	91	1,25
D-05309	91	1,25
D-05315	91	1,25
D-05321	91	1,55
D-05337	91	1,55
D-05343	91	2,15
D-05359	91	2,80
D-05365	91	2,80
D-05371	91	2,80
D-05387	91	3,10
D-07026	93	0,95
D-07032	93	0,95
D-07048	93	0,95
D-07054	93	0,90
D-07060	93	1,25
D-07076	93	1,25
D-07082	93	1,55
D-07098	93	1,55
D-07107	93	2,20
D-07113	93	2,80
D-07129	93	4,40
D-07135	93	6,30
D-07141	93	6,90
D-07157	93	3,30
D-07163	93	3,60
D-07179	93	4,40
D-07185	93	5,30
D-07191	93	6,30
D-07200	93	7,50
D-07216	93	10,10
D-07222	93	12,60
D-07331	93	3,50
D-07347	93	3,60
D-07353	93	5,60
D-07369	93	6,10
D-07375	93	7,00
D-07381	93	7,30
D-07397	93	8,20
D-07406	93	8,50
D-07412	93	9,00
D-07428	93	9,60
D-07559	93	7,60
D-07565	93	8,20
D-07571	93	9,40
D-07587	93	10,20
D-07593	93	11,90
D-07602	93	13,40
D-07618	93	15,30
D-07624	93	16,90
D-07630	93	18,90

Código	Pag	P.V.P.
D-07646	93	22,00
D-07652	93	25,00
D-07668	93	29,00
D-07674	94	1,55
D-07680	94	1,55
D-07696	94	1,55
D-07705	94	1,85
D-07711	94	1,85
D-07727	94	1,85
D-07733	94	1,85
D-07749	94	2,20
D-07755	94	2,20
D-07761	94	2,20
D-07777	94	2,85
D-07783	94	2,85
D-07799	94	2,85
D-07808	94	3,10
D-07814	94	3,40
D-07820	94	3,80
D-07836	94	4,10
D-07842	94	4,10
D-07858	94	4,40
D-07945	154	11,90
D-07951	154	13,30
D-07967	154	15,70
D-08056	61	1,60
D-08062	61	7,10
D-08517	61	9,10
D-08682	76	3,60
D-08707	76	5,90
D-08713	72	4,10
D-08729	72	3,90
D-08735	72	5,20
D-52554	230	13,50
D-09634	230	14,70
D-09640	230	31,00
D-09656	98	0,90
D-09662	98	0,85
D-09678	98	0,90
D-09684	98	0,90
D-09690	98	1,20
D-09709	98	1,20
D-09715	98	1,30
D-09721	98	1,55
D-09737	98	1,75
D-09743	98	1,85
D-09759	98	2,05
D-09765	98	2,40
D-09771	98	2,65
D-09787	98	3,50
D-09793	98	3,20
D-09802	98	3,80
D-09818	98	4,10
D-09824	98	4,70
D-09830	98	6,10
D-09846	98	6,40
D-09852	98	7,00
D-09868	98	7,60
D-09874	98	8,10
D-09880	98	8,80
D-14093	83	2,80
D-14928	99	1,75
D-14934	99	2,05
D-14940	99	2,05
D-14962	99	2,35
D-14978	99	3,20
D-15235	61	7,70
D-15241	61	8,50
D-15257	61	11,10
D-15263	61	12,40
D-15285	79	17,70
D-15300	79	18,40
D-15584	170	15,90
D-15609	170	15,90
D-15621	170	15,90
D-15643	170	15,90
D-15659	170	26,00
D-15665	61	1,25
D-15827	99	6,10
D-15833	99	9,30
D-15849	99	12,30
D-15855	99	15,70
D-15861	93	1,25
D-15877	93	1,25
D-15883	93	1,55
D-15899	93	1,55
D-15908	93	2,20
D-15914	93	2,50
D-15920	93	3,40
D-15936	93	5,40
D-15942	91	2,80
D-15958	91	2,80
D-15964	91	3,05

Código	Pag	P.V.P.
D-15970	91	3,05
D-15986	91	3,70
D-15992	93	4,30
D-16003	93	4,90
D-16019	93	5,80
D-16025	93	6,20
D-16031	93	6,10
D-16047	93	6,30
D-16053	93	7,00
D-16069	93	8,10
D-16075	93	10,20
D-16106	61	1,30
D-16128	61	2,95
D-16271	61	4,90
D-16287	61	6,20
D-16302	61	9,70
D-16318	61	17,60
D-16346	154	7,30
D-16368	73	37,00
D-16863	76	10,00
D-16879	76	6,50
D-16988	279	11,60
D-16994	112	3,70
D-17005	112	4,20
D-17011	112	4,80
D-17027	112	5,50
D-17033	112	5,50
D-17049	112	5,80
D-17055	112	6,40
D-17061	112	6,40
D-17077	112	7,30
D-17083	112	8,50
D-17099	112	8,90
D-17108	112	10,20
D-17114	112	11,50
D-17120	112	11,80
D-17136	112	12,70
D-17142	112	14,60
D-17158	112	18,50
D-17164	112	22,00
D-17170	113	4,30
D-17186	113	7,90
D-17192	113	3,20
D-17251	112	4,50
D-17267	112	5,50
D-17273	112	6,70
D-17289	100	1,45
D-17295	100	1,45
D-17304	100	1,50
D-17310	100	1,55
D-17332	100	1,55
D-17348	100	1,75
D-17354	100	2,05
D-17360	100	2,10
D-17376	100	2,60
D-17382	100	2,75
D-17398	100	3,20
D-17407	100	3,70
D-17413	100	5,00
D-17429	100	6,10
D-17435	100	6,40
D-17441	100	6,40
D-17457	100	8,60
D-17463	100	9,70
D-17479	100	10,80
D-17485	100	11,10
D-17491	100	13,90
D-17500	100	14,00
D-17516	100	16,60
D-17522	100	17,80
D-17538	61	4,50
D-17544	61	5,20
D-17566	61	7,20
D-17572	61	21,00
D-17603	113	6,40
D-17619	113	10,40
D-17631	80	20,00
D-17647	80	20,00
D-17778	99	4,40
D-18459-20	173	27,00
D-18465-20	173	32,00
D-19180	64	60,00
D-19196	77	10,20
D-20074	77	9,00
D-20694	76	5,60
D-20769	105	12,90
D-23759	105	10,20
D-23793	91	2,10
D-23802	91	2,15
D-23818	91	2,90
D-23824	78	9,60
D-23868	79	23,00
D-24072	151	4,10

Código	Pag	P.V.P.
D-24094	151	4,70
D-24119	151	5,60
D-24131	151	6,20
D-24153	151	7,00
D-24876	112	8,20
D-24882	112	9,50
D-25616	72	5,60
D-25688	112	8,90
D-25694	112	10,90
D-27034	176	3,40
D-27040	176	3,40
D-27056	176	3,40
D-27062	176	3,40
D-27084	176	3,90
D-27090	176	3,90
D-27109	176	3,90
D-27115	176	3,90
D-27137	176	7,70
D-27143	176	7,70
D-27159	176	7,70
D-27165	176	7,70
D-28036	177	4,00
D-28042	177	4,00
D-28058	177	4,00
D-28064	177	4,00
D-28086	177	4,50
D-28092	177	4,50
D-28101	177	4,50
D-28117	177	4,50
D-28139	177	7,70
D-28145	177	7,70
D-28151	177	7,70
D-28167	177	7,70
D-28173	177	5,50
D-28189	177	5,50
D-28195	177	5,50
D-28210	177	11,00
D-28226	177	11,00
D-28232	177	11,00
D-28248	177	11,00
D-29050	230	25,00
D-29228	80	21,00
D-29284	151	6,70
D-29290	151	10,20
D-29561	151	6,40
D-29577	151	8,50
D-30140	112	9,50
D-30209	277	23,00
D-30287	92	0,90
D-30293	92	0,90
D-30302	92	0,90
D-30324	92	0,95
D-30346	92	1,25
D-30368	92	1,25
D-30374	92	1,50
D-30380	92	1,55
D-30411	92	2,15
D-30427	92	4,60
D-30449	92	2,45
D-30455	92	2,80
D-30461	92	6,20
D-30477	105	7,10
D-30667	135	12,10
D-31033	92	0,90
D-31061	92	0,95
D-31669	135	54,00
D-31778	109	95,00
D-33691	108	73,00
D-33897	67	14,00
D-33906	67	19,00
D-33934	67	16,00
D-33940	67	20,50
D-33956	67	17,00
D-33962	67	22,00
D-33978	67	19,00
D-33984	67	25,50
D-33990	67	20,50
D-34001	67	28,00
D-34017	67	22,00
D-34023	67	29,50
D-34039	67	22,00
D-34045	67	29,00
D-34051	67	25,50
D-34067	67	39,00
D-34089	67	49,00
D-34095	67	42,00
D-34104	67	54,00
D-34110	67	51,50
D		

Código	Pag	P.V.P.	Código	Pag	P.V.P.	Código	Pag	P.V.P.	Código	Pag	P.V.P.	Código	Pag	P.V.P.
D-39780	151	5,80	D-52613	231	16,70	D-67549	104	49,00	D-73455	106	9,40	D-74728	63	8,80
D-39805	151	7,60	D-52629	231	19,40	D-67561	104	62,00	D-73461	106	32,00	D-74740	134	1,65
D-39827	151	4,90	D-52635	231	22,00	D-67583	104	66,00	D-73477	106	30,00	D-74756	63	9,40
D-39849	151	5,80	D-52766	163	8,70	D-67614	94	1,85	D-73483	104	13,80	D-74778	277	214,00
D-39861	151	5,60	D-53453	93	2,85	D-67692	274	5,60	D-73508	116	17,30	D-74784	277	144,00
D-39883	151	5,80	D-53469	93	3,50	D-67701	274	5,60	D-73514	116	18,60	D-74887	106	17,10
D-39908	148	2,10	D-53475	93	6,40	D-67717	274	5,90	D-73520	116	18,60	D-74893	98	20,00
D-39914	148	2,35	D-53481	93	7,00	D-67739	274	6,70	D-73536	116	11,80	D-74902	98	23,00
D-39920	148	2,60	D-53497	93	10,20	D-67745	274	6,40	D-73542	116	11,10	D-74918	98	26,00
D-39936	148	2,90	D-53506	93	11,40	D-67751	274	6,70	D-73564	152	33,00	D-75297	152	3,50
D-39942	148	3,50	D-53534	278	67,00	D-67767	274	8,60	D-73570	152	33,00	D-75306	152	3,50
D-39958	149	2,05	D-53540	278	70,00	D-67773	274	7,80	D-73586	153	40,00	D-75312	152	3,50
D-39964	149	2,35	D-53556	278	137,00	D-67789	274	10,40	D-73592	153	43,00	D-75328	152	3,50
D-39970	149	2,60	D-54081	104	19,40	D-67804	274	6,20	D-73601	148	1,55	D-75334	152	4,00
D-39986	149	2,95	D-56960	204	2,30	D-67810	274	6,70	D-73617	148	1,80	D-75340	152	4,00
D-39992	149	3,20	D-56982	163	67,00	D-67826	274	7,00	D-73623	148	2,00	D-75356	152	4,00
D-40004	147	1,75	D-56998	163	83,00	D-67832	274	6,70	D-73639	148	2,25	D-75362	152	4,00
D-40010	147	2,05	D-57009	163	97,00	D-67848	274	8,00	D-73645	148	2,80	D-75378	152	4,30
D-40026	147	2,60	D-57065	278	118,00	D-67854	274	8,80	D-73651	149	1,55	D-75384	152	4,30
D-40032	147	2,90	D-61070	169	18,60	D-67860	274	10,20	D-73667	149	1,65	D-75390	152	4,30
D-40048	100	19,10	D-61086	169	19,20	D-67876	274	10,40	D-73673	149	1,85	D-75409	152	4,30
D-40054	100	29,00	D-61092	169	20,00	D-67882	274	11,50	D-73689	149	2,00	D-75415	348	18,70
D-40060	100	54,00	D-61101	169	28,00	D-67898	274	14,40	D-73695	149	2,25	D-75421	348	20,00
D-40076	100	96,00	D-61123	163	8,70	D-67907	274	7,50	D-73704	147	1,45	D-75437	348	22,00
D-40107	100	73,00	D-61145	163	18,70	D-67913	274	7,80	D-73710	147	1,65	D-75443	348	26,00
D-40135	100	83,00	D-61151	163	8,70	D-67929	274	8,80	D-73726	147	2,00	D-75459	348	28,00
D-40163	100	78,00	D-61167	163	10,00	D-67935	274	10,20	D-73732	147	2,25	D-75524	174	1,05
D-40191	100	95,00	D-61173	163	22,00	D-67941	274	11,00	D-73738	148	5,00	D-75530	174	1,05
D-40200	106	16,00	D-61189	163	7,50	D-67957	274	13,10	D-73807	148	5,50	D-75568	174	2,10
D-40565	75	66,00	D-61690	131	2,10	D-67963	274	14,40	D-73813	149	4,80	D-75742	104	10,70
D-41458	166	58,00	D-62505	205	4,90	D-67979	274	15,50	D-73829	149	5,00	D-75758	104	15,50
D-41464	166	66,00	D-62511	205	7,00	D-67985	275	7,80	D-73835	147	2,40	D-75764	113	140,00
D-41517	141	58,00	D-62527	205	8,20	D-68024	275	8,00	D-73841	147	3,10	D-75792	152	4,30
D-41595-10	163	88,00	D-62533	205	4,90	D-68030	275	8,30	D-73857	147	3,60	D-75801	152	4,30
D-41844	94	6,60	D-62549	205	7,00	D-68046	275	11,80	D-73863	147	4,80	D-75817	152	4,30
D-41925	94	7,80	D-62555	205	8,20	D-68052	275	14,20	D-73891	65	7,70	D-75823	152	4,30
D-42232	94	8,90	D-62561	205	4,90	D-68096	275	5,90	D-73900	65	8,20	D-75839	152	5,10
D-42248	94	9,60	D-62577	205	7,00	D-68177	275	8,80	D-73916	65	8,60	D-75845	152	5,10
D-42254	94	10,20	D-62583	205	8,20	D-68183	275	7,00	D-73922	65	10,00	D-75851	152	5,10
D-42260	94	10,70	D-62599	205	4,90	D-68199	275	7,80	D-73938	65	12,90	D-75867	152	5,10
D-42282	94	11,90	D-62608	205	7,00	D-68208	275	7,20	D-73944	65	17,70	DA00000002	342	8,00
D-42298	94	13,70	D-62614	205	8,20	D-68214	275	8,00	D-73950	65	21,00	DA00000169	341	15,45
D-42307	94	18,80	D-62620	205	4,90	D-68220	275	8,80	D-73966	65	24,00	DEAADP06	43	31,00
D-42357	73	32,00	D-62636	205	7,00	D-68236	275	13,40	D-73972	65	1,75	DEAADP08	43	31,00
D-42450	75	49,00	D-62642	205	8,20	D-68242	275	18,70	D-73988	65	4,20	DEADM1805	51	186,00
D-44432	169	39,00	D-62658	205	4,90	D-68323	275	6,70	D-73994	65	6,30	DEADML809	51	474,00
D-44454	169	30,00	D-62664	205	7,00	D-68339	275	8,00	D-74005	65	8,80	DEAML104	54	109,00
D-44476	169	37,00	D-62670	205	8,20	D-68345	275	10,40	D-74011	65	18,70	DEAML106	52	66,00
D-44507	169	47,00	D-63666	154	27,00	D-68351	275	12,60	D-74027	65	24,00	DEAPF400MP	339	240,00
D-44529	169	59,00	D-63747	178	2,00	D-68373	275	7,50	D-74049	237	18,70	DEAWST05	243	349,00
D-44585	169	82,00	D-63753	178	2,00	D-68389	275	11,20	D-74077	238	19,30	DEAWST07	243	435,00
D-44591	169	89,00	D-63769	178	2,00	D-68395	276	9,40	D-74136	63	8,80	DEBDML186	52	26,00
D-44616	169	94,00	D-63775	178	2,00	D-68410	276	13,10	D-74186	178	1,85	DEBDML800	55	49,00
D-44638	169	104,00	D-63781	178	2,30	D-68432	276	16,60	D-74192	178	1,85	DEBDML801	55	51,00
D-45509	148	5,20	D-63797	178	2,30	D-68454	276	9,40	D-74201	178	1,85	DEBDML802	53	59,00
D-45515	148	7,00	D-63806	178	2,25	D-68482	276	13,10	D-74217	178	1,85	DEBDML806	54	82,00
D-45521	148	8,10	D-63812	178	2,25	D-68507	276	16,60	D-74223	178	2,15	DEBDML808	52	66,00
D-45537	148	5,20	D-63828	178	4,50	D-68557	276	11,50	D-74239	178	2,15	DEBDML815	53	42,00
D-45543	148	7,00	D-63834	178	4,50	D-68563	276	11,80	D-74245	178	2,15	DEBML103	55	30,00
D-45559	148	8,10	D-63840	178	4,50	D-68579	276	14,20	D-74251	178	2,15	DEBML105	53	62,00
D-45565	149	4,10	D-63856	178	4,50	D-68591	276	9,40	D-74267	178	4,50	DEBWST06	243	318,00
D-45571	149	5,00	D-64010	99	1,35	D-68622	276	16,60	D-74273	178	4,50	DECADP05	43	32,00
D-45587	149	5,20	D-64026	99	1,35	D-68666	276	11,20	D-74289	178	4,50	DML811	51	315,00
D-45593	149	7,00	D-64032	99	1,35	D-68694	276	12,80	D-74295	178	4,50	DML812	52	159,00
D-45602	149	8,10	D-64048	99	1,35	D-68703	276	10,70	D-74304	95	12,70	DML814	50	452,00
D-45618	149	4,10	D-64054	99	1,35	D-68719	276	15,20	D-74310	95	14,90	DML816X	55	82,00
D-45624	149	5,00	D-64060	99	1,35	D-68753	276	24,00	D-74326	95	16,50	E-00022	135	235,00
D-45630	149	5,20	D-64076	99	1,35	D-68775	276	12,30	D-74332	95	17,70	E-00365	174	1,85
D-45646	149	7,00	D-64082	99	1,35	D-68781	276	13,10	D-74348	95	20,00	E-00371	174	2,40
D-45652	149	8,10	D-64098	99	1,35	D-68806	276	13,60	D-74354	95	24,00	E-00387	174	2,00
D-45668	147	3,20	D-64107	99	1,35	D-68812	276	5,90	D-74360	95	26,00	E-00393	174	2,20
D-45674	147	4,10	D-64113	99	1,50	D-70742	149	11,10	D-74376	95	29,00	E-00402	174	3,00
D-45680	147	4,70	D-64129	99	1,75	D-70758	149	11,10	D-74382	95	34,00	E-00418	174	3,00
D-45696	147	6,40	D-64135	99	1,75	D-70786	205	18,70	D-74398	95	39,00	E-01769	344	3,30
D-45705	147	3,20	D-64141	99	2,00	D-70792	205	18,70	D-74407	95	58,00	E-01775	344	6,20
D-45711	147	4,10	D-64157	99	2,25	D-70801	205	13,10	D-74413	95	67,00	E-01781	344	45,00
D-45727	147	4,70	D-64163	99	2,25	D-70873	204	18,70	D-74429	95	86,00	E-01797	344	4,20
D-45733	147	6,40	D-64179	99	2,50	D-71211	154	15,30	D-74435	95	1,40	E-01806	344	7,90
D-45749	148	8,80	D-64185	99	2,75	D-71962	105	8,50	D-74441	95	1,40	E-01812	344	47,00
D-45755	148	8,80	D-64191	99	3,00	D-72067	238	36,00	D-74457	95	11,00	E-01828	344	4,80
D-45761	151	11,10	D-64200	99	3,25	D-72154	332	25,00	D-74463	95	13,20	E-01834	344	8,70
D-45777	151	14,00	D-64216	99	3,50	D-72160	332	25,00	D-74479	95	16,00	E-01840	344	45,00
D-46202	105	23,00	D-64222	99	4,00	D-72291	231	14,00	D-74485	173	1,05	E-01909	234	44,00
D-47117	113	48,00	D-64238	99										

Código	Pag	P.V.P.	Código	Pag	P.V.P.	Código	Pag	P.V.P.	Código	Pag	P.V.P.	Código	Pag	P.V.P.
E-03202	126	3,30	E-06563	91	3,05	E-11405	66	29,00	E-14788	58	39,00	HW3640630	353	11,60
E-03218	126	3,30	E-06579	91	4,20	E-11411	66	35,00	E-14928	62	51,00	HW3641590	353	47,00
E-03224	126	3,30	E-06585	91	3,40	E-11427	66	34,00	E-14934	92	1,85	HW3640640	352	3,70
E-03230	126	3,30	E-06591	91	4,90	E-11433	66	40,00	E-14940	92	1,85	HW3641590	353	47,00
E-03268	126	6,60	E-06600	91	5,50	E-11449	66	39,00	E-14956	92	2,15	HW3640670	352	2,45
E-03274	126	6,60	E-06616	138	138,00	E-11455	66	45,00	E-14984	92	2,40	HW3640920	352	29,00
E-03280	126	6,60	E-06644	115	24,00	E-11461	66	40,00	E-14990	92	2,65	HW3640940	352	11,30
E-03296	126	6,60	E-06650	115	25,00	E-11477	66	46,00	E-15045	92	3,20	HW3640950	353	6,40
B-63753	126	3,00	E-06666	115	25,00	E-11483	66	50,00	E-15051	92	3,50	HW3641150	352	11,00
E-03311	126	6,60	E-06672	115	27,00	E-11499	66	61,00	E-15067	92	4,00	HW3641570	353	63,00
E-03327	126	6,60	E-06688	115	27,00	E-11508	66	61,00	E-15073	92	4,50	HW40167	352	54,00
E-03333	126	6,60	E-06694	115	28,00	E-11514	66	75,00	E-15089	92	5,40	HW40551	352	31,00
E-03349	126	6,60	E-06703	115	29,00	E-11689	107	121,00	E-15154	363	30,00	HW40925	352	51,00
E-03355	126	6,60	E-06719	115	30,00	E-11782	394	116,00	E-15176	364	22,00	HW41154	352	26,00
E-03361	126	6,60	E-06725	115	33,00	E-11829	108	29,00	E-15182	365	59,00	HW41163	354	60,00
E-03399	127	8,60	E-06731	115	41,00	E-11994	128	8,80	E-15198	366	41,00	HW41165	353	66,00
E-03408	127	9,40	E-06747	115	43,00	E-12011	128	14,90	E-15207	368	52,00	HW41167	353	105,00
E-03414	127	9,90	E-06753	115	43,00	E-12027	126	5,20	E-15213	369	59,00	HW41175	354	59,00
E-03420	127	6,60	E-06769	115	44,00	E-12055	240	303,00	E-15229	370	121,00	HW41179	353	28,00
E-03436	127	6,60	E-06775	115	44,00	E-12217	234	30,00	E-15235	372	149,00	HW41181	353	75,00
E-03442	126	4,40	E-06781	115	45,00	E-12223	234	43,00	E-15241	367	43,00	HW41185	353	19,30
E-03458	126	6,60	E-06797	115	46,00	E-12251	234	61,00	E-15257	374	27,00	HW41187	353	33,00
E-03464	126	6,60	E-06806	115	46,00	E-12267	234	71,00	E-15263	375	27,00	HW41847	352	55,00
E-03470	126	6,60	E-06812	115	48,00	E-12273	234	80,00	E-15279	376	27,00	HW41849	353	77,00
E-03486	126	6,90	E-06828	115	72,00	E-12289	142	14,90	E-15291	378	16,50	HW46221	352	28,00
E-03492	126	9,40	E-06834	115	155,00	E-12304	115	163,00	E-15300	379	15,40	HY00000212	294	207,00
E-03517	126	9,90	E-06840	115	10,70	E-12310	115	150,00	E-15322	381	14,30	JM21000300	259	89,00
E-03523	126	10,20	E-06856	115	15,00	E-12326	115	163,00	E-15338	380	13,20	JM21000320	259	25,00
E-03573	127	25,00	E-06862	115	13,90	E-12354	142	33,00	E-15350	361	12,70	JM21000330	259	16,00
E-03632	114	8,60	E-06878	115	32,00	E-12360	130	14,60	E-15366	383	49,00	JM21080230	259	21,00
E-03654	114	8,60	E-06884	115	35,00	E-12360-12	129	177,00	E-15372	387	43,00	JM21080260	259	11,60
E-03660	114	8,60	E-06895	115	36,00	E-12376	130	14,60	E-15394	391	125,00	JM23000127	244	9,90
E-03676	114	9,10	E-06987	234	48,00	E-12376-12	129	177,00	E-15403	392	86,00	JM23000128	245	0,80
E-03698	114	11,00	E-07026	106	31,00	E-12382	130	14,60	E-15431	393	70,00	JM23000131	245	8,20
E-03707	114	10,50	E-07054	106	26,00	E-12398	130	14,60	E-15453	404	66,00	JM23100500	244	11,40
E-03713	114	10,50	E-07060	138	33,00	E-12407	130	10,50	E-15481	397	159,00	JM23100501	246	3,70
E-03735	114	10,90	E-07294	347	107,00	E-12407-12	129	133,00	E-15512	406	78,00	JM23100501	317	3,70
E-03757	114	11,60	E-07303	347	125,00	E-12413	130	10,50	E-15556	398	21,00	JM23100502	245	6,50
E-03763	114	11,00	E-07319	347	148,00	E-12413-12	129	133,00	E-15584	405	35,00	JM23300008	245	56,00
E-03779	114	12,10	E-07325	347	33,00	E-12429	130	10,50	E-15609	400	77,00	JM23510009	245	11,00
E-03785	114	12,10	E-07331	347	3,40	E-12435	130	10,50	E-15615	403	34,00	JM23510010	246	7,20
E-03791	114	12,70	E-07412	202	47,00	E-12441-10	129	243,00	E-15693	385	30,00	JM23510010	317	7,20
E-03800	114	12,70	E-07428	202	47,00	E-12653	130	14,60	E-15768	128	19,30	JM27000090	259	0,80
E-03822	114	13,20	E-07434	202	47,00	E-12669	130	14,60	E-20096	69	220,00	JM27000090	313	0,80
E-03838	114	14,10	E-07440	202	47,00	E-12675	130	10,50	E-20111	69	250,00	JM27000300	244	320,00
E-03850	114	15,10	E-07456	202	47,00	E-12681	130	10,50	E-20127	69	285,00	JM27110005	245	40,00
E-03866	114	15,10	E-07462	202	87,00	E-12712	395	159,00	E-20155	69	300,00	JM27170001	238	33,00
E-03872	114	15,10	E-07478	202	87,00	E-12790-5	175	68,00	F-30913	291	25,00	LE00772796	322	26,00
E-03894	114	16,10	E-07484	202	87,00	E-12980	399	22,00	F-31140	291	22,00	LE00784968	320	71,00
E-03903	114	17,10	E-07490	202	76,00	E-12996	164	166,00	F-31166	291	22,00	LE00785633	321	15,40
E-03925	114	17,30	E-07509	202	76,00	E-13041	75	61,00	F-31227	291	24,00	LE00785637	321	131,00
E-03931	114	17,30	E-07515	202	76,00	E-13253	237	123,00	F-31230	291	28,00	LE00785638	322	17,90
E-03947	114	20,00	E-07630	347	12,00	E-13312	237	138,00	F-31825	292	14,30	LE00791661	321	104,00
E-03953	114	20,00	E-07646	347	13,20	E-13552	127	40,00	F-31838	292	15,40	LE00796587	320	353,00
E-03969	114	21,00	E-07652	347	15,50	E-13568	127	12,80	F-31841	292	17,30	LE00796588	320	65,00
E-03981	114	27,00	E-08698	105	22,00	E-13596-12	63	149,00	F-31854	292	19,30	LE00822220	322	31,00
E-04008	114	35,00	E-10665	60	6,10	E-13611	347	83,00	F-32142	292	27,00	LE00823195	322	25,00
E-04014	114	43,00	E-10671	60	6,10	E-13627	347	91,00	F-32155	292	31,00	LE00834534	322	20,00
E-04020	114	34,00	E-10718	175	1,65	E-13633	347	98,00	F-32168	292	35,00	LE00837085	320	179,00
E-04036	114	39,00	E-10724	175	1,95	E-13649	347	9,60	F-32171	292	40,00	LE00837096	320	54,00
E-04042	114	34,00	E-10730	107	58,00	E-13655	347	10,20	F-32647	293	14,90	LE00855702	320	236,00
E-04058	114	44,00	E-10861-12	174	21,00	E-13661	347	11,20	F-32650	293	13,20	LE00864505	322	39,00
E-04064	114	45,00	E-10877-12	174	24,00	E-14152	114	22,00	F-32663	293	17,70	LE00870131	321	33,00
E-04070	114	26,00	E-10883	138	215,00	E-14168	114	25,00	F-32676	293	20,00	LE00870134	321	46,00
E-04086	114	6,90	E-10899	137	109,00	E-14174	114	56,00	F-32689	293	21,00	LE00870137	321	77,00
E-04977-5	175	42,00	E-10920	242	89,00	E-14255	92	12,80	F-32689	293	21,00	LE00874658	320	110,00
E-05337	384	17,70	E-10920	272	89,00	E-14261	115	260,00	F-32859	291	34,00	LE00929103	322	46,00
E-05402	388	26,00	E-10920	284	89,00	E-14299	240	72,00	F-33575	292	57,00	LE00929104	321	83,00
E-05658	402	51,00	E-10920	401	89,00	E-14495	58	8,20	F-33588	292	59,00	ML001G	53	54,00
E-05664	242	57,00	E-10936	242	110,00	E-14504	58	9,90	F-33591	292	90,00	ML002G	54	126,00
E-05664	272	57,00	E-10936	272	110,00	E-14510	58	11,60	F-81518	293	25,00	ML003GZ	51	231,00
E-05664	284	57,00	E-10936	284	110,00	E-14526	58	16,00	F-81521	293	19,30	ML005GX	50	330,00
E-05664	401	57,00	E-10936	401	110,00	E-14532	58	7,70	GM00001396	51	22,00	ML006GX	55	90,00
E-05670	242	49,00	E-10958	92	1,60	E-14548	58	9,40	GM00001499	44	25,00	ML007G	52	182,00
E-05670	272	49,00	E-10964	92	1,60	E-14554	58	10,50	GM00001683	54	21,00	ML009GX	50	555,00
E-05670	284	49,00	E-10970	92	1,70	E-14560	58	14,90	GM00002073	51	228,00	ML010G	50	950,00
E-05670	401	49,00	E-10986	92	1,85	E-14576	58	22,00	GM00002283	51	72,00	P-00860	198	4,50
E-06270	107	104,00	E-11003	92	2,20	E-14582	58	28,00	GM00002286	51	21,00	P-00882	198	5,90
E-06286	127	9,90	E-11025	92	2,35	E-14635	58	11,00	GM00002287	51	14,30	P-00907	198	5,90
E-06292	127	9,90	E-11031	92	2,20	E-14641	58	14,90	GM00002358	50	12,50	P-00913	198	5,90
E-06317	237	87,00	E-11053	92	2,95	E-14657	58	17,10	GM000023					

Código	Pag	P.V.P.	Código	Pag	P.V.P.	Código	Pag	P.V.P.	Código	Pag	P.V.P.	Código	Pag	P.V.P.
P-01127	153	65,00	P-06345	131	14,30	P-25096	72	70,00	P-34718	168	26,00	P-38168	196	5,50
P-01155	153	65,00	P-06351	131	14,30	P-25105	73	20,00	P-34724	169	18,70	P-38174	196	5,50
P-01199	201	11,00	P-06367	131	14,30	P-25111	73	27,00	P-35807	193	5,80	P-38180	196	4,40
P-01208	201	11,00	P-06373	131	14,30	P-26191	64	44,00	P-35813	193	5,50	P-38196	196	59,00
P-01214	201	11,00	P-06389	131	14,30	P-26200	64	58,00	P-35829	193	5,20	P-38205	196	48,00
P-01220	201	11,00	P-08361	83	3,30	P-26216	64	59,00	P-35835	193	5,20	P-38211	196	42,00
P-01236	201	11,00	P-10067	169	16,80	P-26222	64	65,00	P-35841	193	5,20	P-38227	196	39,00
P-01395	201	12,10	P-10073	169	17,70	P-30031	169	22,00	P-35857	193	5,20	P-38233	196	39,00
P-01404	201	12,10	P-11835*	121	13,20	P-31566	265	11,20	P-35863	193	5,20	P-38249	196	39,00
P-02319	70	157,00	P-13041	76	22,00	P-31572	265	8,30	P-35879	193	5,20	P-38255	196	39,00
P-02325	116	11,00	P-13057	76	16,00	P-31588	265	10,90	P-35885	193	5,20	P-38261	196	39,00
P-02331	116	15,40	P-13063	76	18,60	P-31594	266	11,40	P-35891	194	5,00	P-38277	196	39,00
P-02347	116	14,90	P-13079	76	22,00	P-31837	194	3,90	P-35900	194	5,00	P-38283	291	31,00
P-02353	116	34,00	P-13100	76	40,00	P-31843	194	3,60	P-35916	194	5,00	P-38788	268	15,50
P-03763	68	9,40	P-13122	77	16,40	P-31859	194	3,60	P-35922	194	5,00	P-38794	268	15,50
P-03779	68	91,00	P-13138	77	21,00	P-31865	194	3,60	P-36011	194	3,60	P-39394	201	32,00
P-03785	68	95,00	P-13144	77	16,70	P-31871	194	5,50	P-36027	194	3,60	P-39419	201	32,00
P-03791	68	116,00	P-13150	77	20,00	P-31887	194	5,00	P-36033	194	3,60	P-39425	201	32,00
P-03800	68	131,00	P-13166	77	29,00	P-31893	194	5,00	P-36049	194	3,60	P-40082	170	771,00
P-03816	68	154,00	P-13188	77	25,00	P-31902	194	5,00	P-36136	194	3,30	P-40098	170	37,00
P-03822	68	178,00	P-13219	77	58,00	P-31918	197	7,70	P-36142	194	3,05	P-40107	170	1,95
P-03838	68	10,00	P-13231	81	19,30	P-31924	197	7,40	P-36158	194	3,05	P-40113	170	10,20
P-03844	69	146,00	P-13253	81	25,00	P-31930	197	7,20	P-36267	195	4,40	P-40129	170	4,70
P-03850	69	178,00	P-13275	81	19,30	P-31946	197	6,90	P-36273	195	4,10	P-40288	170	13,20
P-03866	69	220,00	P-13297	81	22,00	P-31952	197	6,90	P-36289	195	4,10	P-41551	168	45,00
P-03872	69	280,00	P-13306	81	29,00	P-31968	197	6,90	P-36398	192	4,10	P-41604	168	45,00
P-03888	69	60,00	P-13312	81	33,00	P-31974	197	6,90	P-36407	192	3,60	P-41610	168	42,00
P-03894	69	50,00	P-13334	81	58,00	P-31980	197	6,90	P-36413	192	3,30	P-41626	168	52,00
P-03925	69	97,00	P-13378	78	19,00	P-31996	197	6,90	P-36429	192	3,30	P-41648	168	85,00
P-03931	69	22,00	P-13384	78	25,00	P-32007	197	6,90	P-36516	192	5,00	P-41676	169	52,00
P-03947	75	82,00	P-13390	78	26,00	P-32013	197	6,90	P-36522	192	4,40	P-41682	169	51,00
P-04008	69	138,00	P-13409	78	20,00	P-32904	192	3,60	P-36538	192	4,40	P-41698	169	42,00
P-04014	69	196,00	P-13415	78	26,00	P-32910	192	3,30	P-36544	192	4,40	P-41707	169	48,00
P-04020	69	200,00	P-13487	79	32,00	P-32926	192	3,30	P-36550	192	4,40	P-41735	170	13,20
P-04036	69	396,00	P-13493	79	75,00	P-32932	192	3,05	P-36566	192	4,40	P-41866	169	20,00
P-04400	152	116,00	P-13502	79	33,00	P-32948	194	3,05	P-36572	192	4,40	P-41872	169	143,00
P-04416	153	93,00	P-13518	79	78,00	P-32954	194	3,05	P-36588	192	4,40	P-41888	169	27,00
P-04422	153	110,00	P-13552	131	4,00	P-32960	194	2,45	P-36675	201	5,20	P-41903	169	79,00
P-04438	153	111,00	P-13568	131	6,30	P-32976	195	4,10	P-36681	201	4,70	P-41919	169	3,60
P-04444	153	111,00	P-13574	131	3,90	P-32982	195	4,10	P-36697	201	4,70	P-41931	169	5,20
P-04450	153	111,00	P-13580	131	6,00	P-32998	195	3,30	P-36706	201	4,70	P-41981	169	11,60
P-04466	153	110,00	196193-0	120	39,00	P-33009	195	4,70	P-00125	201	5,15	P-42151	169	35,00
P-04874	250	14,90	P-16237	74	8,60	P-33015	195	4,40	P-36728	201	4,70	P-42684	193	4,40
P-04896	250	14,90	P-16243	74	12,70	P-33021	195	4,40	P-36734	201	4,70	P-42690	193	4,10
P-04955	250	16,60	P-16259	74	16,80	P-33037	195	4,40	P-36887	200	13,80	P-42709	193	4,40
P-05038	255	22,00	P-16265	74	8,60	P-33043	195	4,40	P-36893	200	12,70	P-42715	193	4,10
P-05044	255	26,00	P-16271	74	12,70	P-33059	195	4,40	P-36902	200	12,70	P-42721	193	4,10
P-05050	255	55,00	P-16287	74	16,80	P-33065	195	4,40	P-36918	200	12,70	P-42737	193	4,10
P-05066	255	49,00	P-16293	74	27,00	P-33071	195	4,10	P-36924	200	12,70	P-42743	193	4,10
P-05088	251	22,00	P-16302	74	17,10	P-33087	193	5,00	P-36930	200	12,70	P-42759	193	4,10
P-05474	82	27,00	P-16318	74	26,00	P-33093	193	5,00	P-36946	200	12,70	P-42765	193	4,10
P-05480	82	30,00	P-16324	74	26,00	P-33102	193	5,00	P-37091	200	9,90	P-42868	192	6,60
P-05496	82	26,00	P-16330	75	52,00	P-33118	193	5,00	P-37100	200	9,60	P-42874	192	6,60
P-05505	72	9,90	P-16346	74	66,00	P-33124	193	4,40	P-37116	200	9,60	P-42880	192	6,30
P-05511	72	9,90	P-16352	75	30,00	P-33130	193	4,40	P-37122	200	9,60	P-42896	192	6,30
P-05527	72	14,90	P-16374	68	257,00	P-33146	193	4,40	P-37138	200	9,60	P-42905	192	6,30
P-05533	72	16,00	P-16782	136	17,10	P-33152	193	4,40	P-37144	200	9,60	P-42911	192	6,00
P-05549	79	33,00	P-16994	68	46,00	P-33168	193	4,40	P-37150	200	9,60	P-42927	192	6,00
P-05555	79	81,00	P-17005	68	64,00	P-33174	195	6,90	P-37172	200	10,50	P-42933	192	6,00
P-05561	79	48,00	P-17027	70	79,00	P-33180	195	6,60	P-37188	200	9,90	P-43022	195	7,70
P-05583	79	47,00	P-17033	67	33,00	P-33196	195	6,60	P-37194	200	9,40	P-43038	195	7,20
P-05608	79	62,00	P-17049	67	42,00	P-33205	195	6,60	P-37203	200	9,10	P-43044	195	6,90
P-05614	77	22,00	P-17055	67	59,00	P-33211	195	6,60	P-37219	200	9,10	P-43050	195	6,60
P-05620	77	16,50	P-17077	67	37,00	P-33233	195	6,30	P-37225	200	9,10	P-43066	195	6,60
P-05636	77	15,60	P-17083	67	45,00	P-33249	195	6,30	P-37231	200	9,10	P-43072	195	6,00
P-05642	77	21,00	P-17108	67	37,00	P-33255	193	4,10	P-37312	200	11,60	P-43088	195	6,60
P-05658	77	25,00	P-17114	67	46,00	P-33255	219	4,10	P-37328	200	11,00	P-43094	195	6,60
P-05664	77	31,00	P-18029	153	62,00	P-33261	193	4,10	P-37334	200	10,50	P-43181	201	5,80
P-05670	77	67,00	P-18035	153	62,00	P-33261	219	4,10	P-37340	200	9,60	P-43197	201	5,80
P-05686	77	40,00	P-18041	153	62,00	P-33277	193	4,10	P-37356	200	9,60	P-43206	201	5,50
P-05692	80	30,00	P-18057	153	68,00	P-33277	219	4,10	P-37362	200	9,60	P-43212	201	5,50
P-05701	80	52,00	P-18150	83	47,00	P-33283	193	3,90	P-37378	200	9,60	P-43228	201	5,50
P-05717	80	75,00	P-19233	153	68,00	P-33283	219	3,90	P-37839	197	7,40	P-43234	201	5,50
P-05723	80	29,00	P-19249	153	68,00	P-33299	193	3,90	P-37845	197	6,90	P-43240	201	5,50
P-05929	268	14,30	P-21375	131	22,00	P-33299	219	3,90	P-37851	197	6,60	P-43256	201	6,60
P-05941	143	46,00	P-21381	131	22,00	P-33308	193	3,90	P-37867	197	6,30	P-43262	201	6,60
P-05963	143	40,00	P-21397	131	22,00	P-33314	193	3,90	P-37873	197	6,30	P-43278	201	6,30
P-06030	131	8,80	P-21406	131	22,00	P-33314	219	3,90	P-37889	197	6,30	P-43284	201	6,30
P-06046	131	26,00	P-21593	131	5,00	P-33320	193	3,90	P-37895	197	6,30	P-43290	201	6,30
P-06052	131	8,80	P-21618	131	22,00	P-33320	219	3,90	P-37904	197	6,30	P-43309	201	6,30
P-06068	131	25,00	P-21727	205	15,40	P-33336	193	3,90	P-37910	197	6,30	P-43315	201	6,30
P-06074	131	8,80	P-21733	205	10,80	P-33342	197	5,00	P-37926	197	6,30	P-43321	201	8,60
P-06080	131	25,00	P-21777	199	13,20	P-33358	197	4,70	P-37932	197	6,30	P-43337	201	8,20
P-06096	13													

Código	Pag	P.V.P.	Código	Pag	P.V.P.	Código	Pag	P.V.P.	Código	Pag	P.V.P.
P-43583	197	5,00	P-64076	168	44,00	P-78031	66	65,00	SE00000501	41	15,40
P-43599	197	5,00	P-64082	168	46,00	P-78047	66	79,00	SE00000679	41	33,00
P-43608	197	4,70	P-64098	168	46,00	P-78053	66	120,00	SH00000034	315	84,00
P-43614	197	4,70	P-64107	168	50,00	P-78075	66	78,00	SH00000042	315	12,70
P-44074	133	12,70	P-64113	168	51,00	P-78081	66	90,00	SH00000058	315	26,00
P-45082	169	37,00	P-64129	168	52,00	P-78097	66	109,00	SH00000060	315	79,80
P-45680	253	18,30	P-64272	80	65,00	P-78134	66	94,00	SH00000065	313	50,40
P-45696	253	22,00	P-64288	80	50,00	P-78140	66	111,00	SH00000213	313	89,25
P-45705	249	18,30	P-64319	90	30,00	P-78156	66	111,00	SH00000231	313	64,05
P-45711	249	22,00	P-64331	90	36,00	P-78162	66	134,00	SH00000313	313	90,30
P-45727	249	27,00	P-64347	64	6,70	P-78178	66	179,00	SH00000314	313	44,10
P-45749	267	8,60	P-64347	90	6,70	P-78184	66	244,00	STEX122299	208	112,00
P-45864	293	15,90	P-64462	90	31,00	P-78190	66	189,00	STEX122312	156	68,00
P-45870	293	17,10	P-64478	90	31,00	P-78215	66	215,00	STEX122312	317	68,00
P-45886	293	21,00	P-64484	90	35,00	P-81088	320	140,00	STEX122385	286	39,00
P-45892	293	25,00	P-64490	90	36,00	P-81309	322	99,00	TD00000111	43	66,00
P-45901	293	27,00	P-64509	90	37,00	P-81315	320	269,00	TE00000333	46	0,85
P-45917	293	30,00	P-64515	90	39,00	P-81739	313	39,00	TE00000334	46	0,55
P-45923	292	12,40	P-64521	90	41,00	P-81739	314	39,00	TE00000335	46	0,60
P-45939	292	14,10	P-64537	90	45,00	P-81745	313	22,00	TE00000597	46	1,35
P-45945	292	16,50	P-64543	90	45,00	P-81745	316	22,00	TEB0000006	41	34,00
P-45951	292	17,70	P-64559	90	45,00	P-81789	313	28,00	TK02100200	322	20,00
P-45967	292	21,00	P-64565	90	46,00	P-81789	315	28,00	TKOLDG301G	320	343,00
P-46997	249	16,10	P-64571	90	49,00	P-84084	313	70,00	TKOLDG501G	320	243,00
P-47008	249	21,00	P-64587	90	56,00	P-84084	314	70,00	TKOLM4001F	320	151,00
P-47014	254	15,40	P-64593	90	57,00	PDC1200A01	41	1.984,00	TKOLM5030F	320	218,00
P-47064	253	20,00	P-64602	90	58,00	PDC1200A02	41	1.863,00	UA-1048	341	4,50
P-47086	251	13,70	P-64618	90	59,00	PILOT	101	9,60	W107402706	313	15,40
P-47092	251	14,90	P-64630	90	61,00	PILOTS	101	7,70	W107402706	315	15,40
P-47101	252	21,00	P-64646	90	66,00	PR00000028	288	8,20	W107418350	313	35,00
P-47117	251	16,60	P-64652	90	68,00	PR00000029	288	8,20	W107418350	315	35,00
P-47123	252	17,80	P-64668	90	89,00	PR00000030	288	10,50	W107418351	316	66,00
P-47173	255	17,20	P-64858	353	22,00	PR00000031	288	8,80	W107418352	316	39,00
P-47189	254	16,10	P-64864	354	18,70	PR00000032	288	17,40	W107418353	316	39,00
P-47195	254	21,00	P-64870	354	10,50	PR00000033	288	19,20	W107418355	316	35,00
P-47204	267	10,60	P-64892	353	46,00	PR00000034	288	8,20	W107418661	316	20,00
P-47210	267	10,00	P-64901	352	41,00	PR00000035	288	11,10	W107418688	313	30,00
P-47226	267	8,30	P-64917	352	89,00	PR00000039	288	9,60	W107418688	316	30,00
P-47232	268	8,30	P-65648	152	112,00	PR00000041	288	22,00	W14295	315	4,40
P-47357	346	9,10	P-65931	80	39,00	SC00000203	326	116,00	W29541	316	4,70
P-47363	346	11,00	P-65947	80	39,00	SC00000205	326	116,00	W6084	313	5,50
P-49622	267	11,20	P-66503	353	51,00	SC00000207	326	116,00	W6084	316	5,50
P-49638	267	12,60	P-66793	131	13,20	SC00000209	326	116,00	WL00000002	41	9,90
P-49644	269	14,30	P-66824	131	13,20	SC00000211	326	116,00	WL00000058	41	82,00
P-52174	173	1,20	P-67393	76	33,00	SC00000213	326	116,00	YL00000003	43	41,00
P-52180	173	1,40	P-67745	64	22,00	SC00000215	326	116,00			
P-52196	173	2,55	P-67745	169	22,00	SC00000217	326	116,00			
P-52205	173	1,40	P-67751	64	34,00	SC00000219	326	116,00			
P-52211	173	3,05	P-67767	254	26,00	SC00000221	326	116,00			
P-52227	173	3,30	P-67773	131	17,70	SC00000223	326	116,00			
P-52233	174	3,30	P-67789	131	21,00	SC00000244	326	116,00			
P-52249	174	1,40	P-67795	131	17,70	SC00000246	326	116,00			
P-52255	174	1,40	P-67804	131	21,00	SC00000248	326	116,00			
P-52819	173	4,70	P-70297	316	38,00	SC00000250	326	116,00			
P-52928	173	1,95	P-70346	313	32,00	SC00000252	326	116,00			
P-52934	173	1,95	P-70346	315	32,00	SC00000254	326	116,00			
P-52940	173	1,65	P-70378	313	25,00	SC00000256	326	116,00			
P-52962	173	2,20	P-70378	316	25,00	SC00000258	326	116,00			
P-52978	173	1,65	P-70415	316	10,50	SC00000260	326	116,00			
P-52984	173	1,95	P-70421	313	20,00	SC00000262	326	116,00			
P-52990	173	2,80	P-70421	316	20,00	SC00000264	326	116,00			
P-53001	174	1,40	P-70421	316	20,00	SC00000266	326	116,00			
P-53017	174	1,40	P-70437	313	45,00	SC03300790	325	86,00			
P-53023	174	1,45	P-72899	316	28,00	SC03801080	325	94,00			
P-53039	174	1,45	P-72908	313	26,00	SC05332710	326	116,00			
P-53045	174	1,40	P-72942	313	30,00	SC05340040	326	116,00			
P-53051	174	1,45	P-72942	315	30,00	SC05340050	326	116,00			
P-53067	174	3,30	P-77730	66	39,00	SC05340060	326	116,00			
P-53073	174	1,40	P-77746	66	46,00	SC05340070	326	116,00			
P-53089	174	1,95	P-77768	66	162,00	SC05340080	326	116,00			
P-53095	174	1,45	P-77774	66	44,00	SC05340090	326	116,00			
P-53126	174	1,40	P-77780	66	48,00	SC05340100	326	116,00			
P-53148	173	4,10	P-77805	66	165,00	SC05340110	326	116,00			
P-53154	173	5,50	P-77811	66	44,00	SC05340120	326	116,00			
P-53263	132	18,70	P-77827	66	50,00	SC05340130	326	116,00			
P-53914	70	204,00	P-77833	66	73,00	SC05340140	326	116,00			
P-53920	70	29,00	P-77855	66	49,00	SC05340150	326	116,00			
P-53936	70	36,00	P-77861	66	54,00	SC05340160	326	116,00			
P-53942	70	50,00	P-77877	66	77,00	SC05340200	326	159,00			
P-54075	132	19,30	P-77883	66	179,00	SC05340210	326	159,00			
P-54178	169	210,00	P-77899	66	52,00	SC05340220	326	159,00			
P-54184	169	30,00	P-77908	66	60,00	SC05340230	326	159,00			
P-54190	170	1.417,00	P-77914	66	51,00	SC05340240	326	159,00			
P-54221	169	104,00	P-77920	66	60,00	SC05340250	326	159,00			
P-57102	168	72,00	P-77936	66	90,00	SC05340260	326	159,00			
P-57118	168	74,00	P-77958	66	65,00	SC05340270	326	159,00			
P-57124	168	74,00	P-77964	66	57,00	SC05340280	326	159,00			
P-57146	168	74,00	P-77970	66	68,00	SC05340290	326	159,00			
P-57152	168	75,00	P-77986	66	88,00	SC05340300	326	159,00			
P-57174	168	77,00	P-77992	66	105,00	SC05340310	326	159,00			
P-63797	75	44,00	P-78003	66	196,00	SC05352510	326	116,00			
P-63806	168	104,00	P-78019	66	63,00	SE00000078	41	17,70			
P-64060	168	42,00	P-78025	66	74,00	SE00000101	41	26,00			

## NORTE

### ASSEADA

R. Presa Rei, 209, Carregosa  
3720 OLIVEIRA AZEMÉIS  
Tel.: 256 412 357  
www.asseada.com

### BRICOFEL

Z. Ind. Cantarias, Lt. 167  
5300 BRAGANÇA  
Tel.: 273 312 371  
www.bricofel.com

### J.M.M.

R. da Boavista, 40, Lordelo  
4816 GUIMARÃES  
Tel.: 252 840 510  
www.jmm.pt

### MACHADO & CARDOSO

R. Prof. Dr. José Azevedo Ferreira 38  
Maximinos 4701 BRAGA  
Tel.: 253 617 883  
www.machadoecardoso.pt

### OXIBEIRAS

R. Estádio Municipal, 6 R/C  
6300 GUARDA  
Tel.: 271 222 788  
www.oxibeiras.pt

### VHS

R. da Gandarra, 1223, Touginho  
4480 VILA DO CONDE  
Tel.: 252 684 560  
www.vhs.pt

## CENTRO

### ABR

R. Casal Frazão, S/N  
2025 AMIAIS BAIXO  
Tel.: 249 870 716  
www.abr.pt

### AGROSPORT

Est. Várzeas Casal 3, Pinheiros  
2070 CARTAXO  
Tel.: 243 770 514  
www.agrosport.pt

### BENEMÁQUINA

R. Monges de Cister, 10 A  
2475 BENEDITA  
Tel.: 262 921 359

### BOBINADORA POMBALENSE

Estrada Nacional, 1, Moncalva  
3100 POMBAL  
Tel.: 236 209 970

### MAQUIVEDRAS

Av. 10 de Junho, 73-75  
2565 TORRES VEDRAS  
Tel.: 261 950 060  
www.maquivedras.pt

### PARAMÁQUINAS

Lugar do Brejo, Est. Ponte, Fração C,  
Antanho 3040 COIMBRA  
Tel.: 239 442 059  
www.paramaquinas.com

### OLEIREP OLEIROS

R. Monsenhor Romão, 8  
6160-426 OLEIROS  
Tel.: 272 681 100  
www.oleirep.com

### OLEIREP SERTÃ

R. 1º Dezembro, Outeiro, 25  
6100-743 SERTÃ  
Tel.: 274 098 006  
www.oleirep.com

### OLEIREP PROENÇA-A-NOVA

R. St. Cruz, 123,  
6150-424 PROENÇA-A-NOVA  
Tel.: 272 681 100  
www.oleirep.com

## SUL

### FEREXCEL LISBOA

R. Virgílio Ferreira, 14B  
1600-223 LISBOA  
Tel.: 212 267 000  
www.ferramentas.pt

### FEREXCEL SETÚBAL

Pátio José Varejeira, 5  
2845-352 AMORA  
Tel.: 212 267 000  
www.ferramentas.pt

### FIEL TÉCNICA

Pçt. São João Bosco, 8  
2735 CACÉM  
Tel.: 219 134 725  
www.fieltecnica.pt

### JAIME MACHADO SANTOS

Zona Ind. Lt. 2  
2665 Malveira  
Tel.: 219 855 855

### PROVEDA

Av. de Angola, 60  
2530 LOURINHÃ  
Tel.: 261 413 044  
www.proveda.pt

### LUIS LANDEIRO

Lt. Ind. Pinheiral LT. 23, Chincato  
8600-306 LAGOS  
Tel.: 282 769 353  
www.luislandeiro.pt

## AÇORES

### ELETROXI

R. Juventude, 17 R/C Esq.  
9500 ILHA SÃO MIGUEL  
Tel.: 291 930 380  
www.electroxi.com

### LOS LIVE OUR STYLE

R. Serpa Pinto, 41, Horta  
9990 FAIAL  
Tel.: 292 391 990

### TERCEIRA FARMA

Pico Redondo, 145, Praia Vitória  
9700 TERCEIRA  
Tel.: 295 512 509  
www.terceirafarma.com

## MADEIRA

### SOMATERIAL

Caminho Igreja, 36, Caniço  
9125 FUNCHAL  
Tel.: 291 930 380















# Catálogo de **ACESSÓRIOS**

2023 / 24



**Centro Emp. Alverca, Armazém C2, C3, C4**  
**Urbanização Vale das Ervas, 2615-187, Alverca, Portugal**  
**Telf: 219 936 750**  
**customer.service@makita.pt**



**www.makita.pt**